

Technische Daten



Spiegelverkehrte Montage möglich

Artikelnummer:

612 120

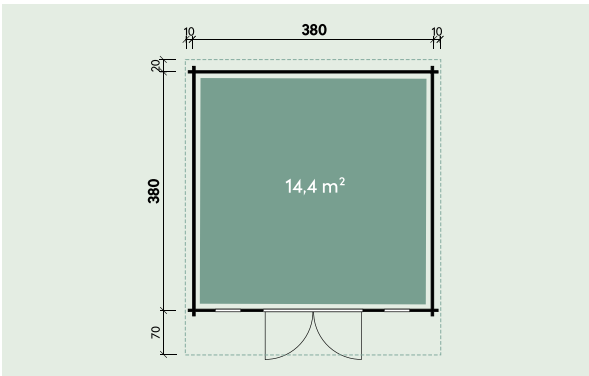

Kontrolliert durch:

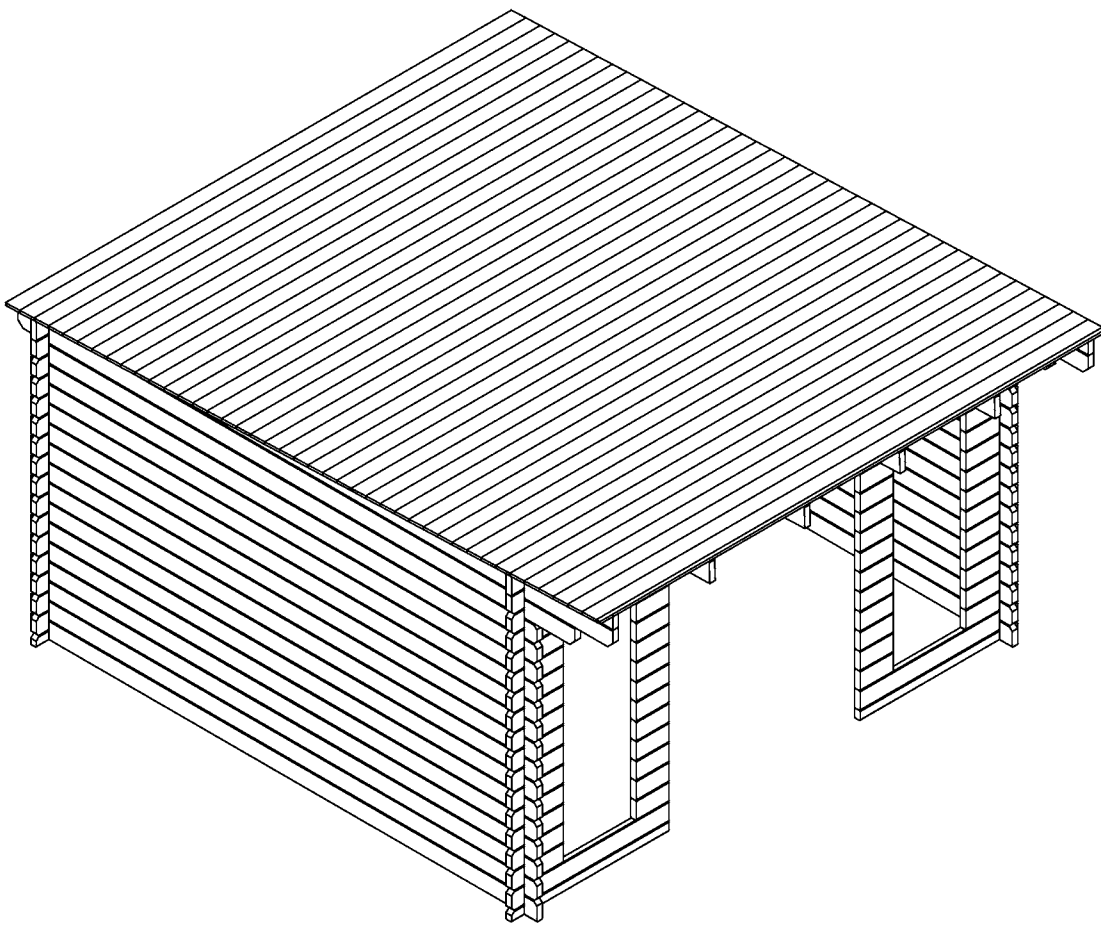

Date 09.10.2025

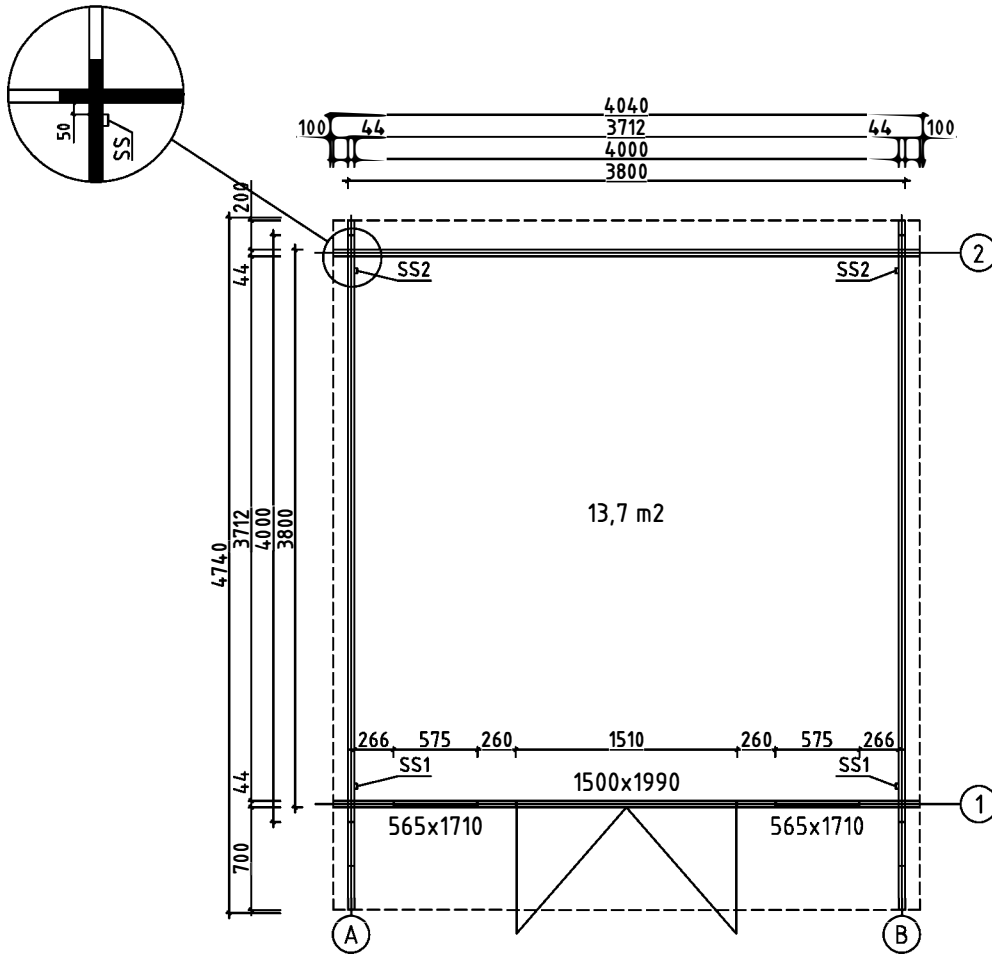

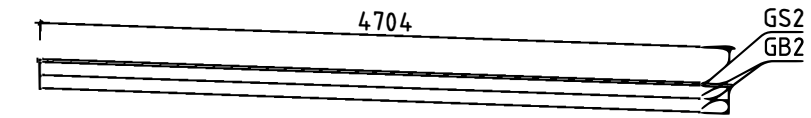
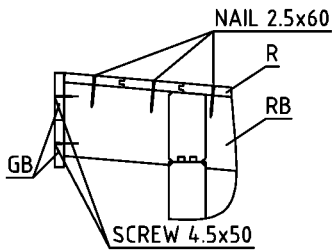
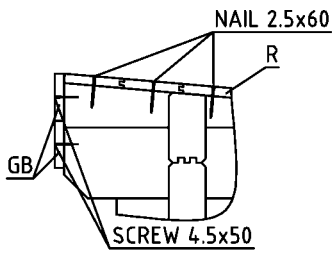

2.1°

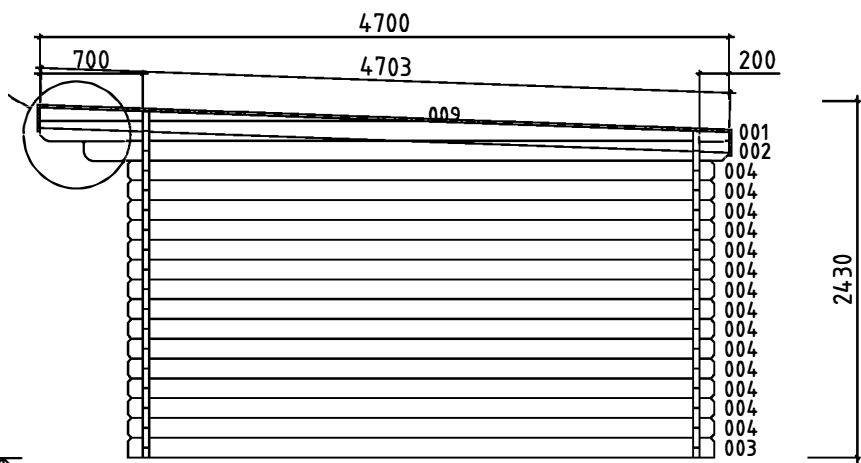



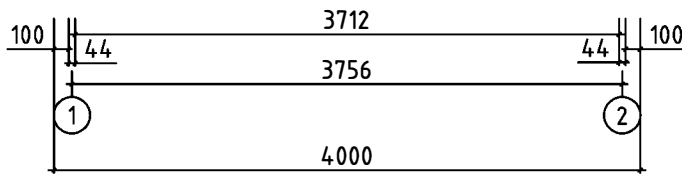

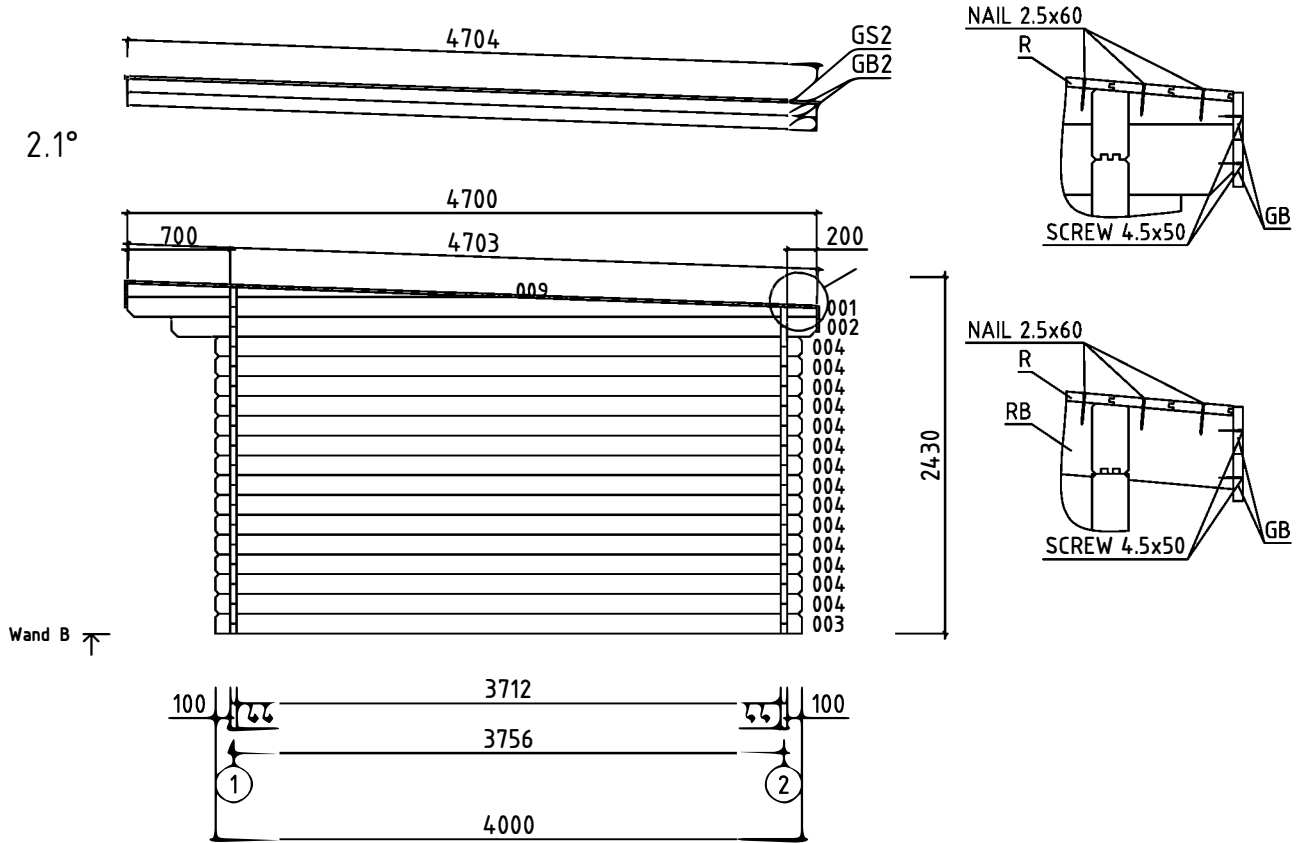

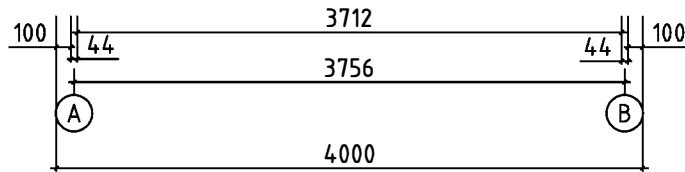
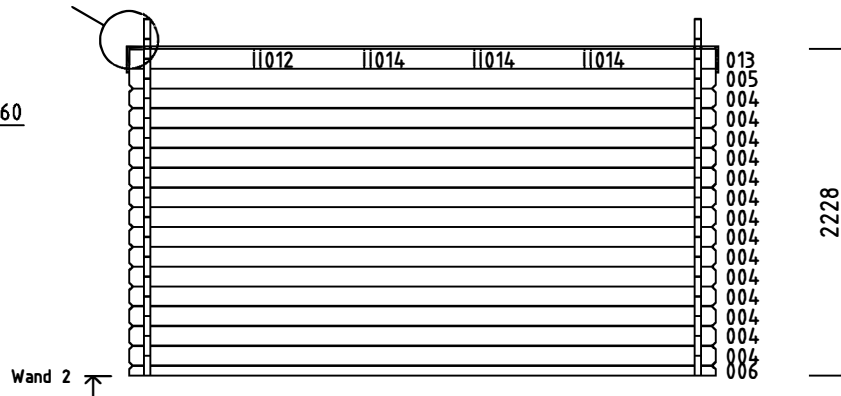
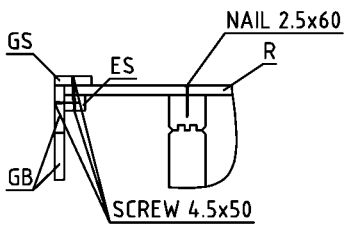
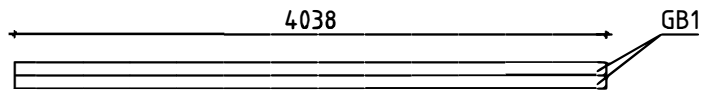
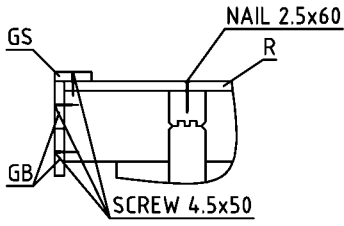

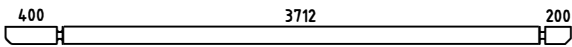
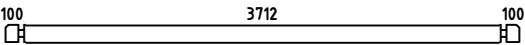
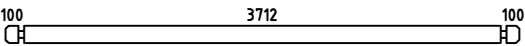
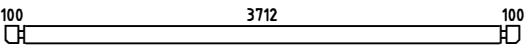
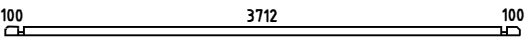
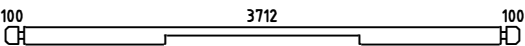
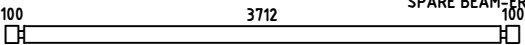
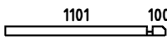
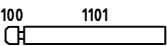
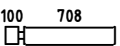
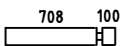



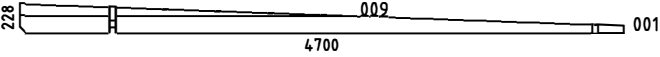
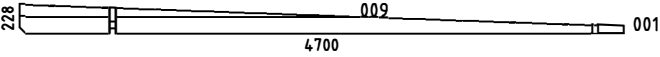

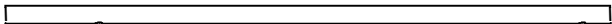

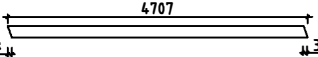











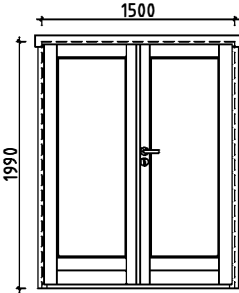

Wand A ↗





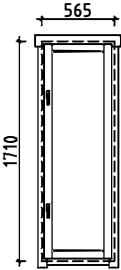

Pos		Stck.	Profil (mm)	Pikkus (mm)
002		2	44x135	4400
003		2	44x135	4000
004		42	44x135	4000
005	 PM	2	44x135	4000
006		1	44x68	4000
007		1	44x135	4000
008	 SPARE BEAM-ERZATZBOHLE-MADRIER DE RÉSERVE	1	44x135	4000
010		2	44x68	1245
011	 PM	2	44x135	1245
012		2	44x135	852
013		2	44x135	852
014		6	44x135	708
015		26	44x135	410
016		26	44x135	260
WA-1		1	44x228	4700
WB-1		1	44x228	4700
HB	HIT BLOCK-SCHLAGHÖLZER-MADRIERS D'ASSEMBLAGE 	2	44x135	300
RB1	ROOFBEAMS-DACHBALKEN-SOLIVES DE PLAFOND 	4	43x140	4708
R1	ROOFBOARD-DACHBRETT-VOLIGES  or-oder-ou	42+1 55+1	114x18 88x18	4000
GB1	GABLE BOARD-GIEBELBLENDE-PLANCHE DE RIVE 	4	18x90	4038
GB2	GABLE BOARD-GIEBELBLENDE-PLANCHE DE RIVE 	4	18x90	4707
GS1	ROOF FELT FILLET-GIEBELLEISTE-BAGUETTES POUR FIXER LES PLANCHES DE RIVE 	1	18x70	4038
GS2	ROOF FELT FILLET-GIEBELLEISTE-BAGUETTES POUR FIXER LES PLANCHES DE RIVE 	2	18x70	4705
ES1	EAVE SLAT-TRAUFENLEISTE-BAGUETTES POUR FIXER LES LATTES SOUS VOLIGES 	2	30x40	3710
ES2	EAVE SLAT-TRAUFENLEISTE-BAGUETTES POUR FIXER LES LATTES SOUS VOLIGES 	2	30x40	700

Pos		Stck.	Profiil (mm)	Pikkus (mm)
ES3	EAVE SLAT-TRAUFENLEISTE-BAGUETTES POUR FIXER LES LATTES SOUS VOLIGES 	2	30x40	200
SS1	STORM SLAT-STURMLEISTE -BAGUETTE DE TEMPETE 	2	18x35	2290
SS2	STORM SLAT-STURMLEISTE -BAGUETTE DE TEMPETE 	2	18x35	2160
	SCREWS-SCHRAUBEN-VISSESS1, SS2 FOR-FÜR-POUR 	12	Ø6.0	50
	WASHER-SCHEIBE-RONDELLE SS1, SS2 FOR-FÜR-POUR 	12	Ø6.0	18
	NAIL-NAGEL-CLOUS R1 	350	Ø2.5	60
	SCREWS-SCHRAUBEN-VIS GB1, GB2, GS1, GS2, ES1, ES2, ES3 FOR-FÜR-POUR 	96	Ø4.5	50
	SCREWS-SCHRAUBEN-VIS WA-1, WB-1, RB1 FOR-FÜR-POUR 	16	Ø6.0	160
	<p>DOUBLEDOOR-DOPPELTÜR-DUBBELE DEUR (right-rechts-rechts) AST_PRE P</p>      	1	1500	1990
	<p>WINDOW-FENSTER-FENÊTRE (1x right-rechts-droit 1x left-links-gauche) AST_PRE P+V</p>     	1+1	565	1710

Doppeltür 1500x1990

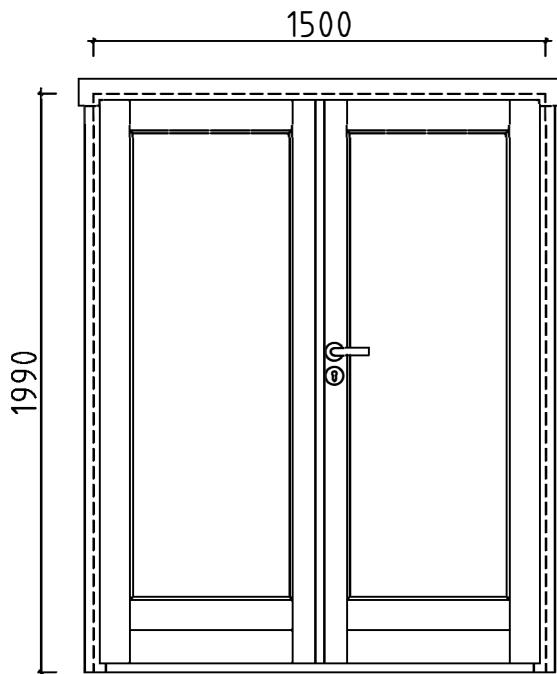

- Länge/Breite: 46 mm
- Rahmenleisten auf beiden Seiten:
seitlich 18 x 70, oben 18 x 90
- Seitliche Rahmenleisten auf beiden
Seiten: vorhanden
- Öffnung: nach außen
- Tür-/Fensterblatt: Mantel
- Scharniere: 3D-Bolzenscharniere
- Verriegelbar: ja
- Türschwelle: mit Edelstahlblech
- Glas: Isolierglas (Mehrfachverglasung)
- Windleiste: außen
- Einliegender Riegel

Einzeltür 565x1710

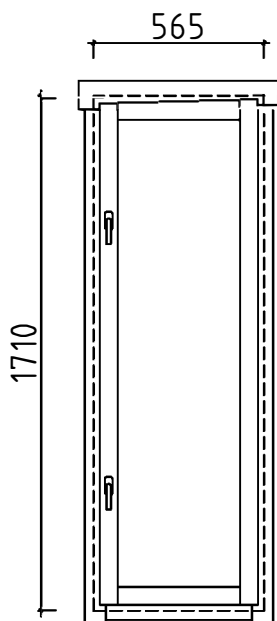

- Länge/Breite: 46 mm
- Rahmenleisten auf beiden Seiten:
seitlich und unten 18 x 70, oben 18 x 90
- Öffnung: nach innen
- Tür-/Fensterblatt: Mantel
- Dichtung: vorhanden
- Kipp- und Drehöffnung
- Mit Kremone bedienbar
- Aluminiumleiste + Wasserfalz
- Glasklasse: Isolierglas
(Mehrfachverglasung)