

Assembly, installation and maintenance manual

Montage-, Aufbau- und Wartungsanleitung • Assemblage, manuel de montage et d'entretien • Montaje, instalación y mantenimiento • Manuale di montaggio, installazione e manutenzione • Monterings- og vedlikeholdsmanual • Monterings-, installations- och underhållsmanual • Kokoamis-, asennus- ja huolto-ohje • Vejledning for montering og vedligehold • Handleiding voor montage, installatie en onderhoud • Manual de montagem, instalação e manutenção • Návod k montáži, instalaci a údržbě • Instrukcja montażu, instalacji i konserwacji • Surinkimo, montavimo ir priežiūros vadovas • Montāžas, uzstādīšanas un apkopes rokasgrāmata • Руководство по сборке и обслуживанию • Montaaži-, paigaldus- ja säilitamise juhend



Pavilion **PA44-2424**

Treatment options, Item code • Behandlungsoptionen, Artikel-Code • Traitement options, code de l'article • Opciones de tratamiento, código del artículo • Opzioni di trattamento, codice articolo • Behandlingsalternativer, artikkelnummer • Behandlingsalternativ, varukod • Käsittelevaihtoehdot, yksikön koodi • Behandlingsmuligheder, artikel nummer • Behandlingsopties, artikelnummer • Opções de tratamento, código do artigo • Povrchové úpravy, kód položky • Možności leczenia, kod produktu • Apdorojimo variantai, prekės kodas • Apstrādes iespējas, artikula kods • Варианты обработки, код изделия • Töötlusvõimalused, tootekood

<p>Factory inspection by • Werkskontrolle durch • Contrôle à partir de l'usine par • Inspector de fábrica • Collaudato da • Fabrikkkontroll utført av • Fabriksbesiktigat av • Tehtaan tarkastaja • Fabriks Kontrol udført af • Fabrikscontrole door • Inspeção de fábrica, por: • Zkontrolováno ve výrobním závodě • Kontrola fabryczna do • Apžiūrą gamykloje atliko • Rūpnīcas pārbaudi veicis • Заводской контроль • Tehase kontroll teostatud:</p> <p>.....</p>	<p>Date • Datum • Date • Fecha • Data • Dato • Datum • Päiväys • Dato • Datum • Data • Datum • Data • Datums • Data • Дата • Kuupäev:</p> <hr/> <p>Pack number • Pack Nr. • Packet n° • Bulto N° • Pacco N. • Serienr • Produktionsnummer • Pakettinro • Pakke nr. • Pak nr. • Número de embalagem • Číslo balení • Numer opakowania • Pakuotės numeris • Iepakojumā numurs • Упаковочный номер • Pakinumber:</p>
---	---



www.palmako.ee/information-hub

English: Before installing and using the product, please read the instructions and warranty terms at www.palmako.ee/information-hub to guarantee proper installation and long-lasting performance.

Deutsch: Wichtig! Bitte vor Aufbau und Nutzung des Produkts unbedingt die detaillierte Montageanleitung sowie die Garantiebedingungen unter www.palmako.ee/information-hub lesen, um eine fachgerechte Montage und eine lange Funktionssicherheit zu gewährleisten.

Français: Avant d'installer et d'utiliser le produit, veuillez lire les instructions et les conditions de garantie sur www.palmako.ee/information-hub afin de garantir une installation correcte et la longévité du produit.

Español: Antes de instalar y utilizar el producto, lea las instrucciones y las condiciones de garantía en www.palmako.ee/information-hub para asegurar una instalación correcta y una larga vida útil del producto.

Italiano: Prima di installare e utilizzare il prodotto, leggere le istruzioni e le condizioni di garanzia su www.palmako.ee/information-hub per garantire una corretta installazione e prestazioni durature.

Norsk: Før montering og bruk av produktet, vennligst les monteringsanvisningene og garantivilkårene på www.palmako.ee/information-hub for å sikre korrekt montering og fremtidig holdbarhet.

Svenska: Innan du installerar och använder produkten, vänligen läs instruktionerna och garantivillkoren på www.palmako.ee/information-hub för att säkerställa korrekt installation och produktens långvariga hållbarhet

Suomi: Ennen tuotteen asentamista ja käyttämistä, lue ohjeet ja takuehdot osoitteessa www.palmako.ee/information-hub varmistaaksesi oikean asennuksen ja pitkäkestoisen toiminnan.

Русский: Перед установкой и использованием изделия ознакомьтесь с инструкцией и условиями гарантии на сайте www.palmako.ee/information-hub, чтобы гарантировать правильную установку и долговечность изделия.

Eesti: Enne toote paigaldamist ja kasutuselevõttu lugege palun juhiseid ja garantiitingimusi aadressil www.palmako.ee/information-hub, et tagada nõuetekohane paigaldus ja toote pikk eluiga.

Dansk (Oversat af AI): Læs venligst instruktionerne og garantibetingelserne på www.palmako.ee/information-hub, før du installerer og bruger produktet, for at garantere korrekt installation og langvarig ydeevne.

Dutch (Vertaald door AI): Lees vóór de installatie en het gebruik van het product de instructies en garantievoorwaarden op www.palmako.ee/information-hub om een correcte installatie en langdurige werking te garanderen

Português (Traduzido por IA): Antes de instalar e utilizar o produto, leia as instruções e os termos de garantia em www.palmako.ee/information-hub para garantir uma instalação adequada e um desempenho duradouro.

Čeština (Přeloženo umělou inteligencí): Před instalací a použitím produktu si prosím přečtěte pokyny a záruční podmínky na www.palmako.ee/information-hub, abyste zaručili správnou instalaci a dlouhodobý výkon.

Polski (Przetłumaczone przez AI): Przed zainstalowaniem i użyciem produktu należy przeczytać instrukcję oraz warunki gwarancji dostępne na stronie www.palmako.ee/information-hub, co pozwoli zagwarantować prawidłową instalację i długotrwałą wydajność.

Latviešu (Mākslīgā intelekta tulkojums): Pirms produkta uzstādīšanas un lietošanas, lūdzu, izlasiet instrukcijas un garantijas noteikumus vietnē www.palmako.ee/information-hub, lai garantētu pareizu uzstādīšanu un ilgstošu darbību.









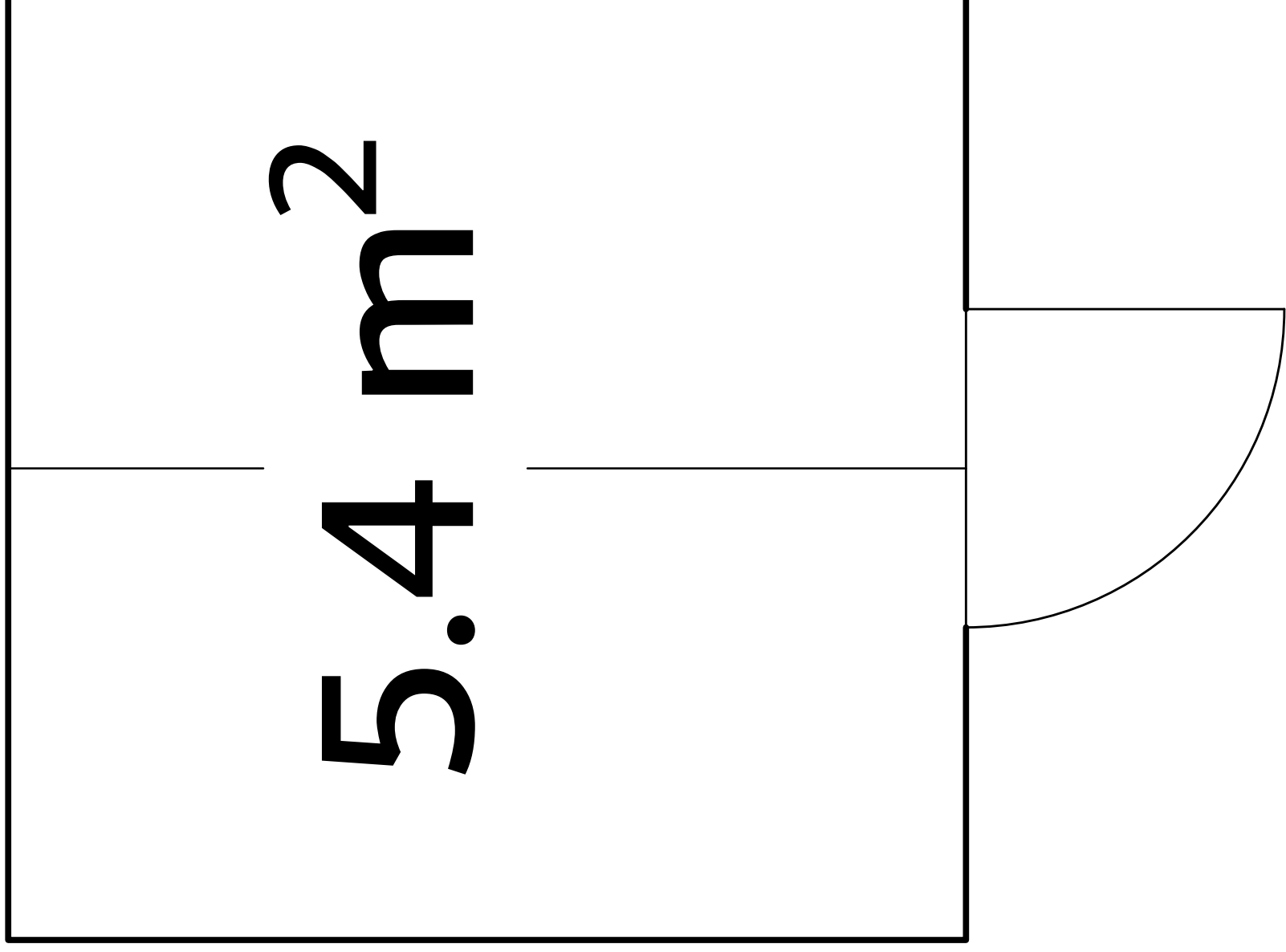

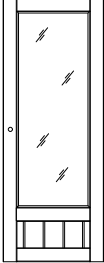
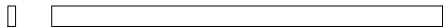

Lietuviškai (Išvertė DI): Prieš montuodami ir naudodami gaminį, perskaitykite instrukcijas ir garantijos sąlygas adresu www.palmako.ee/information-hub, kad užtikrintumėte tinkamą montavimą ir ilgalaikį veikimą.

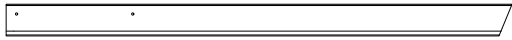
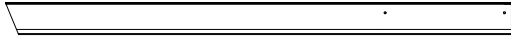

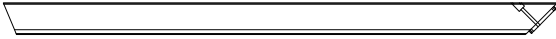
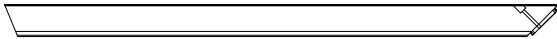
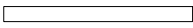
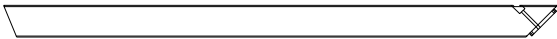

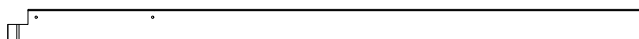
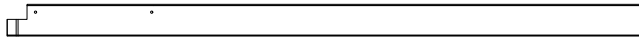

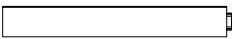

240

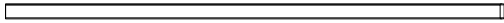
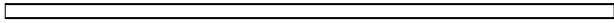

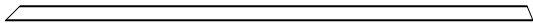
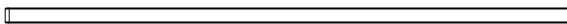
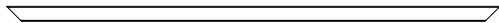
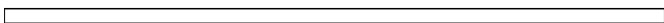
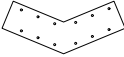

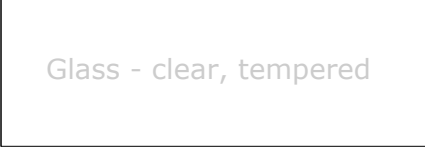



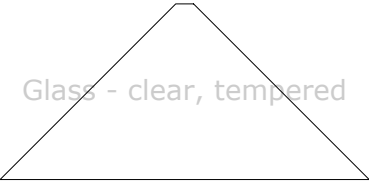
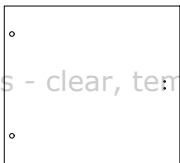

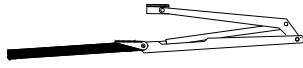

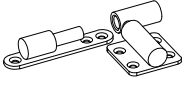
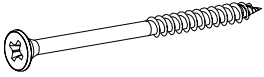
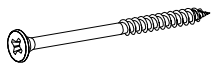
5.4 m²

244

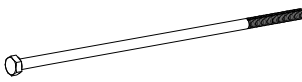

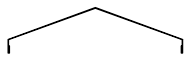
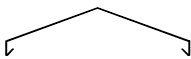
Pos.	Description	Measures (mm)	Pcs
EL1		707 x 390 x 45	2
EL2		2210 x 390 x 45	1
EL3		2348 x 390 x 45	2
KUL-145		696 x 1818 x 40	1
1		2310 x 120 x 45	2
2		2436 x 120 x 45	2
3		1502 x 95 x 44	2
4		1502 x 95 x 44	2
5		1562 x 95 x 44	6
6		1655 x 95 x 44	2
7		1655 x 95 x 44	2
8		554 x 45 x 45	1
9		1655 x 95 x 44	6
10		1893 x 95 x 44	2
11		1893 x 95 x 44	1
12		1893 x 95 x 44	1
13		1737 x 95 x 44	2
14		681 x 91 x 44	2
15		2584 x 200 x 60	1

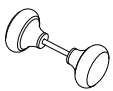
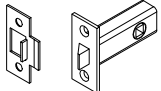
Pos.	Description	Measures (mm)	Pcs
20		1496 x 45 x 12	10
21		1827 x 45 x 12	6
22		1481 x 45 x 12	4
23		1584 x 45 x 12	4
24		1688 x 45 x 12	10
25		1481 x 45 x 12	2
26		2428 x 45 x 12	2
33		370 x 158 x 15	16
101	Glass - clear, tempered 	578 x 1115 x 4	8
102	Glass - clear, tempered 	578 x 1670 x 4	7
103	Glass - clear, tempered 	578 x 1030 x 4	1
104	Glass - clear, tempered 	730 x 1458 x 4	4
105	Glass - clear, tempered 	730 x 1458 x 4	1
106	Glass - clear, tempered 	690 x 1450 x 4	2
107	Glass - clear, tempered 	620 x 690 x 4	1

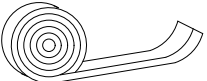
Pos.	Description	Measures (mm)	Pcs
F1		Thermovent 7kg	1
F2		55 x 60	2
F3		62 x 40 x 13	10
F4	 QHP15x57Zn	15 x 57	2
F5	 QKRPP6x120RVTX	Ø 6 X 120	12
F6	 QKRPP5x90RVTX	Ø 5 X 90	70
F7	 QKRYP5x55RVTX	Ø 5 X 55	210
F8	 QKRYP4_2x38RVTX	Ø 4.2 X 38	210
F9	 QKRPP3_5x40RVTX	Ø 3.5 X 40	6
F10	 QKRPP4x25RVTX	Ø 4 X 25	12
F11	 Polt M6	Ø 6 X 200	5
F12	 QMUKK6Zn	M6	5
F13	 QSE6x18Zn	Ø 6 X 18	10
F14		1290 x 200 x 46	2
F15		100 x 201 x 47	1
F16	 QHA150Zn	150 mm	1
F17	 QUNAL		1set
F18	 QRUAu		1set
F19	 QLIKA		1set
F20	 QTI3x8MU	0.6 m	1

Emilia 5.4 specification 3(3)

det 1 - 2 pcs
det 2 - 2 pcs
F5 - 8 pcs

1

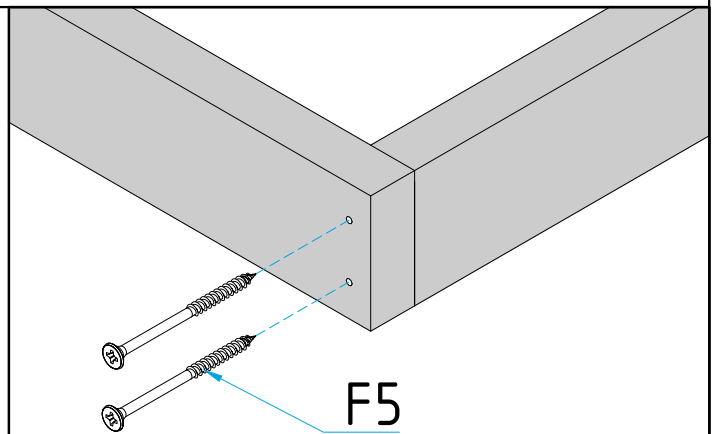
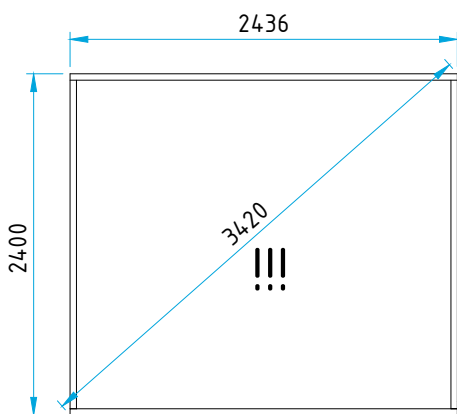
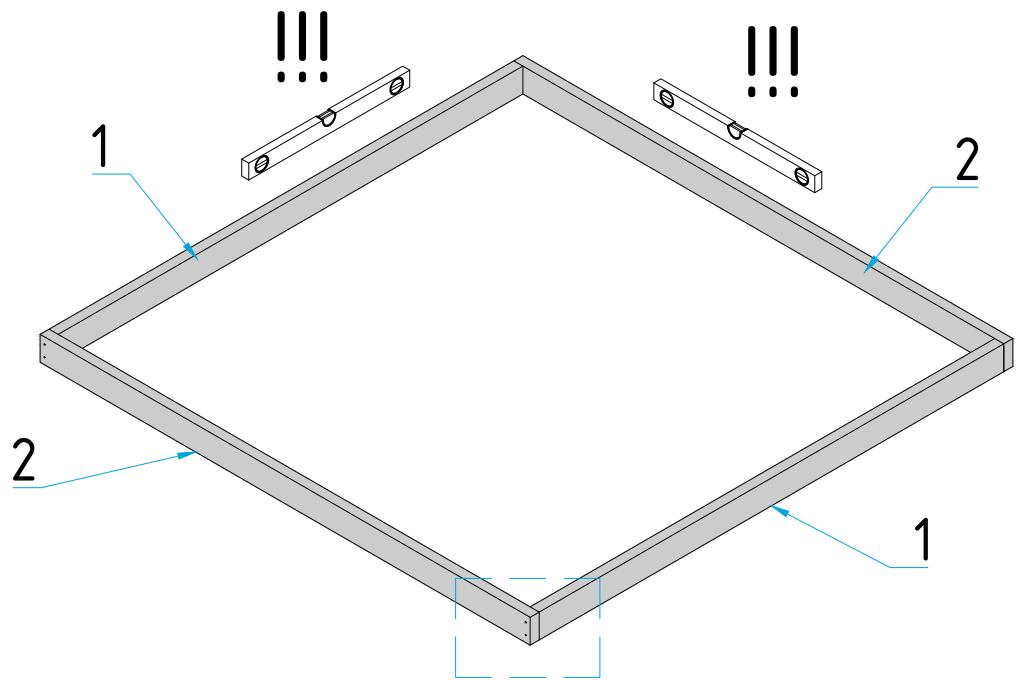

- EL 1 - 2 pcs
- EL 2 - 1 pcs
- EL 3 - 2 pcs
- F6 - 16 pcs

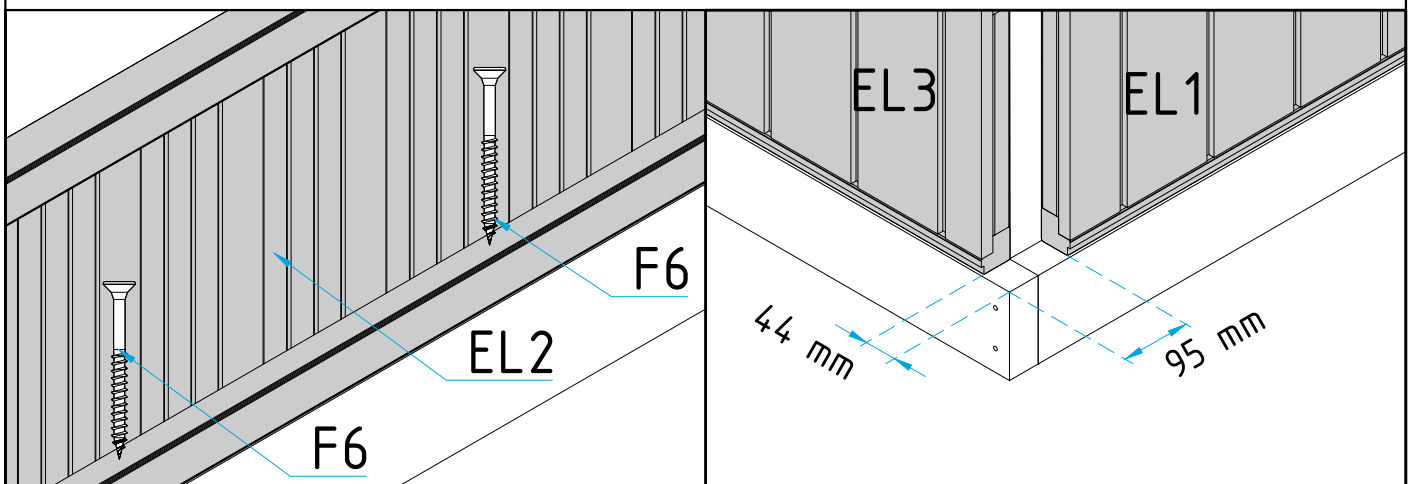
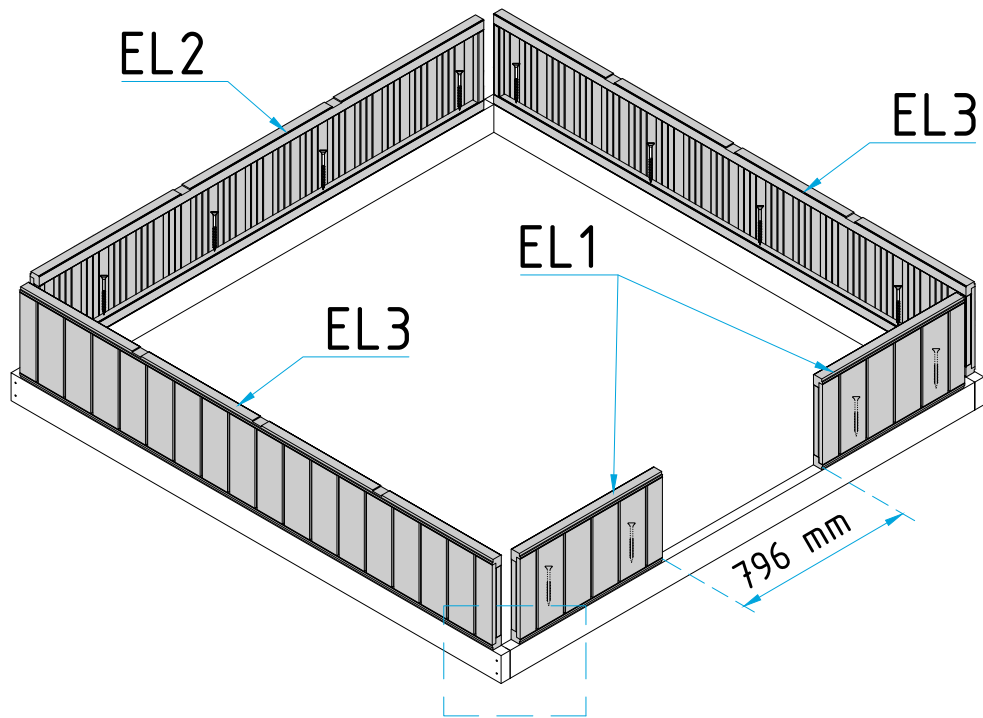

- det 3 - 2 pcs
- det 4 - 2 pcs
- det 6 - 2 pcs
- det 7 - 2 pcs
- det 33 - 4 pcs
- F6 - 16 pcs
- F7 - 48 pcs

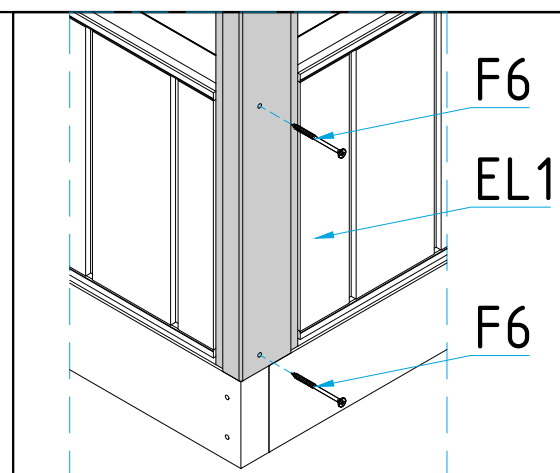
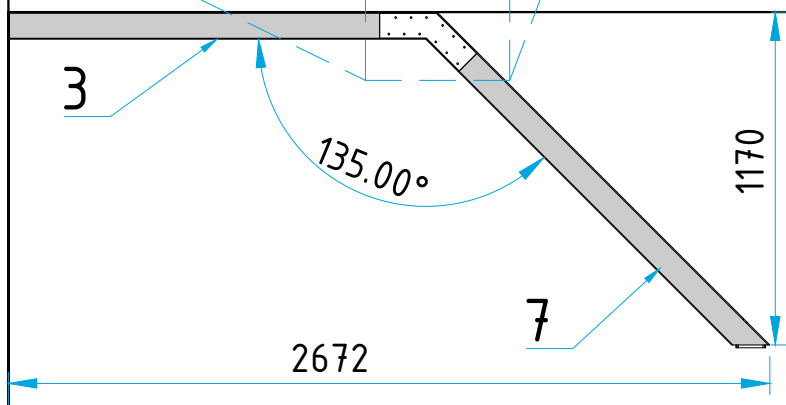
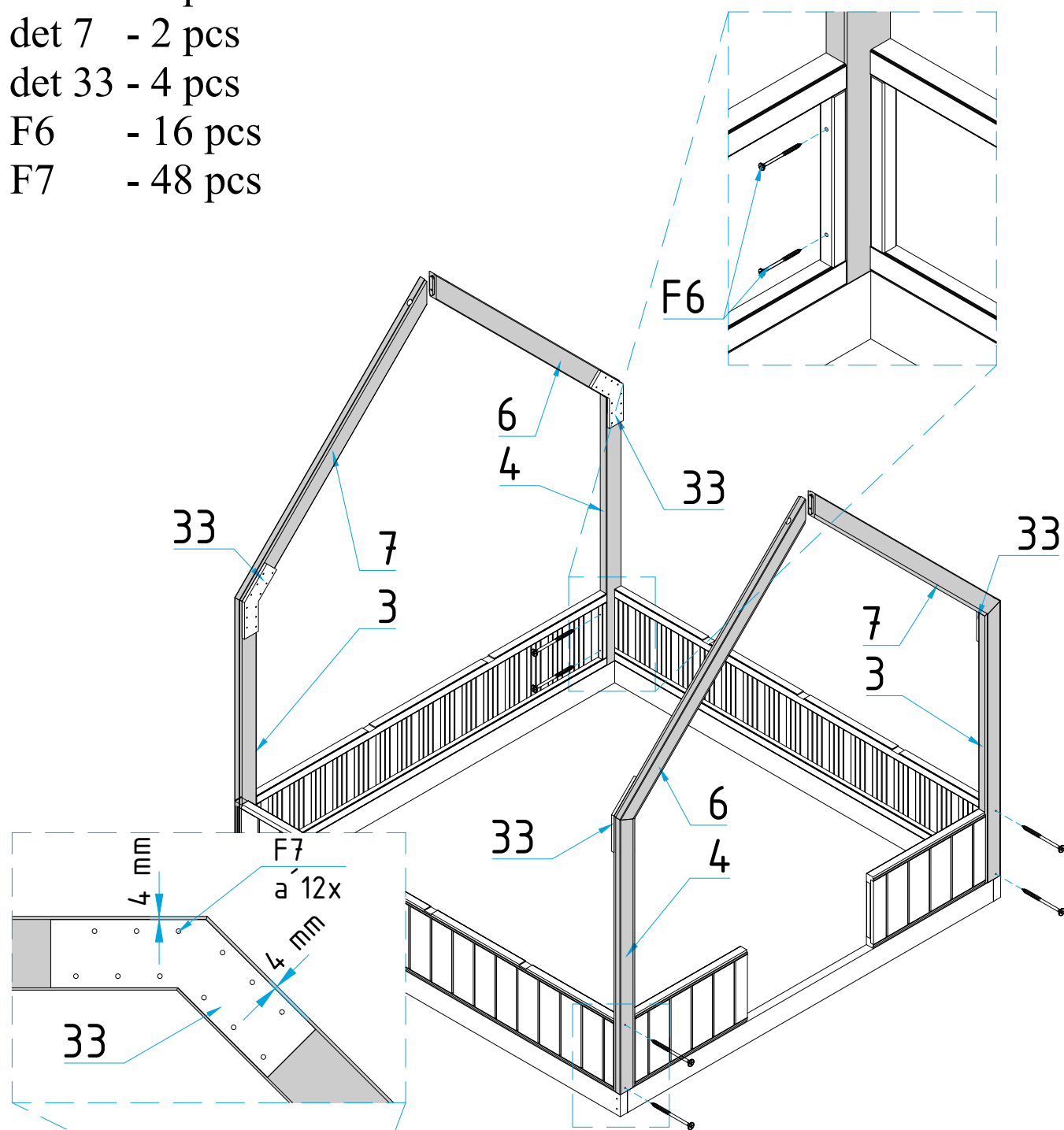

det 15 - 1 pcs

F11 - 2 pcs

F12 - 2 pcs

F13 - 4 pcs

4

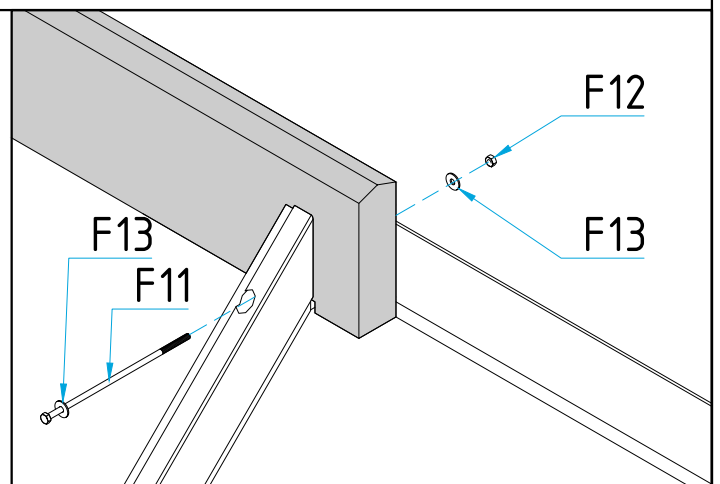
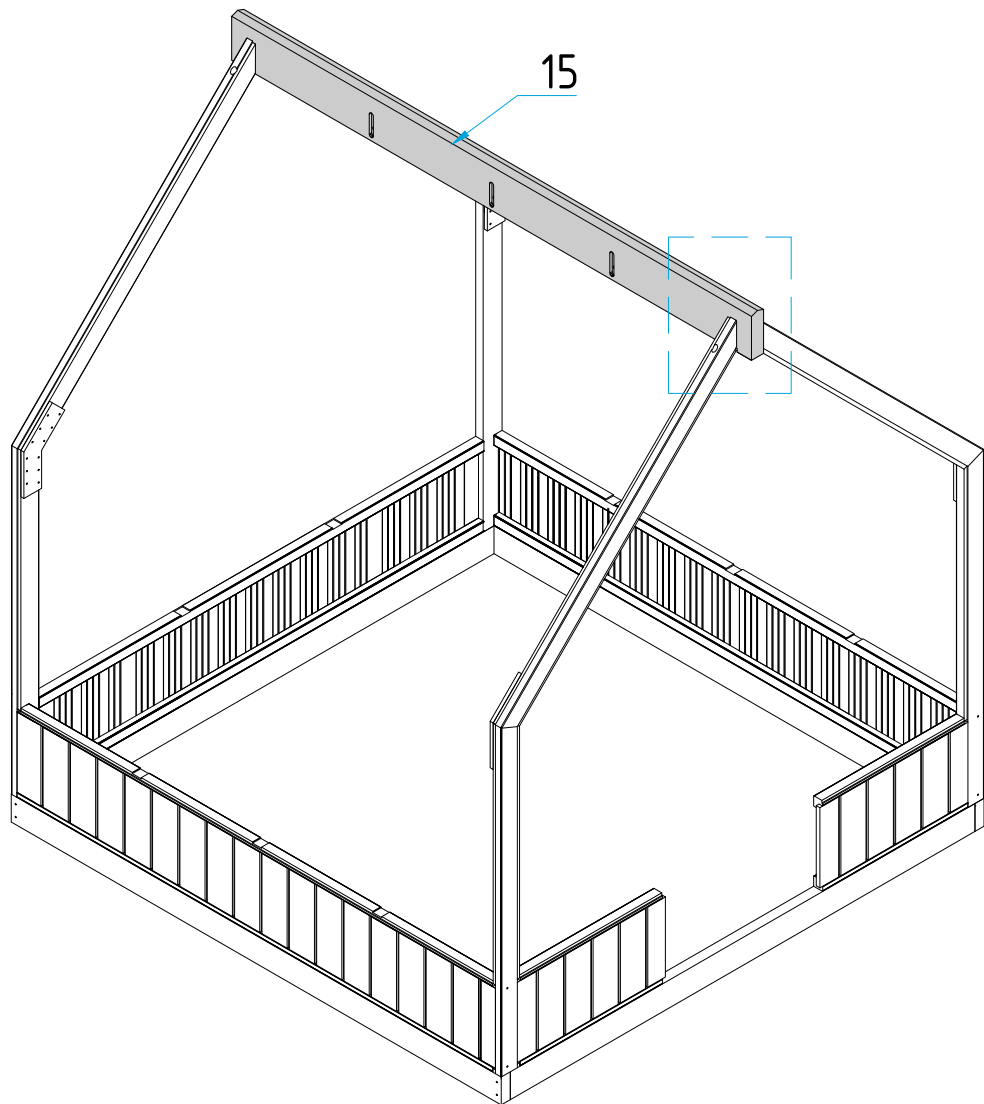

- det 10 - 2 pcs
- det 11 - 1 pcs
- det 12 - 1 pcs
- det 13 - 2 pcs
- det 14 - 2 pcs

F6 - 30 pcs

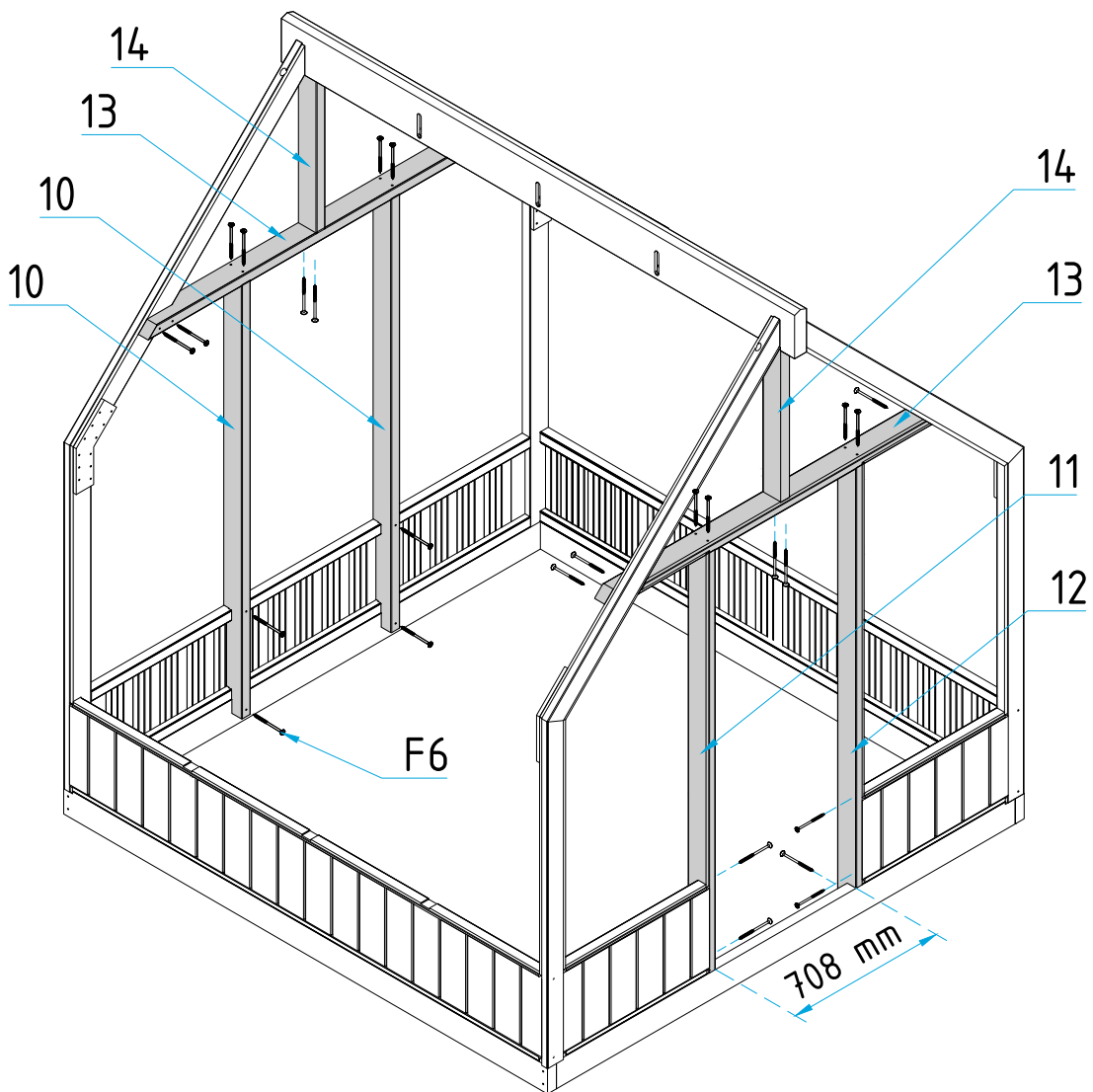

det 5 - 6 pcs
 det 8 - 1 pcs
 det 9 - 6 pcs
 det 33 - 12 pcs

det 26 - 2 pcs
 F6 - 14 pcs
 F7 - 154 pcs
 F11 - 3 pcs
 F12 - 3 pcs
 F13 - 6 pcs

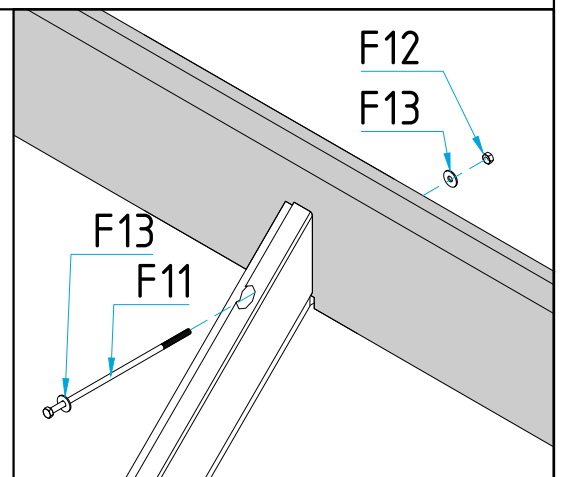
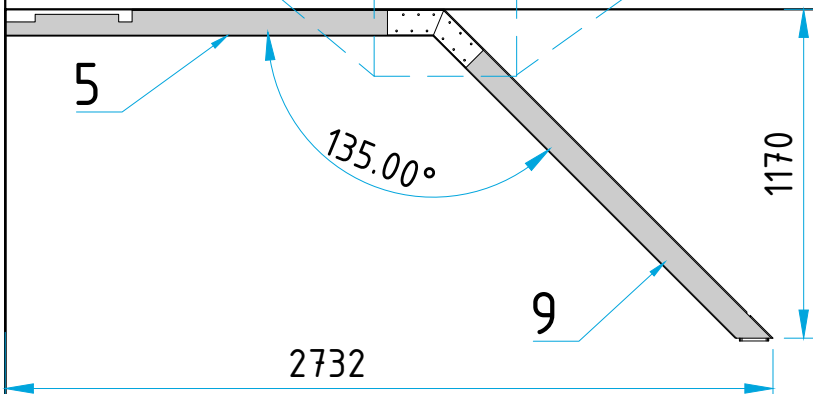
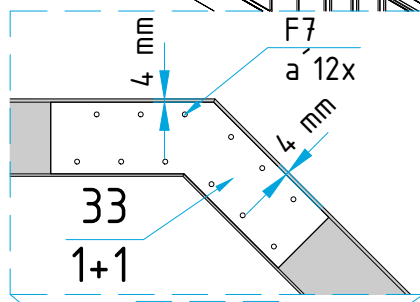
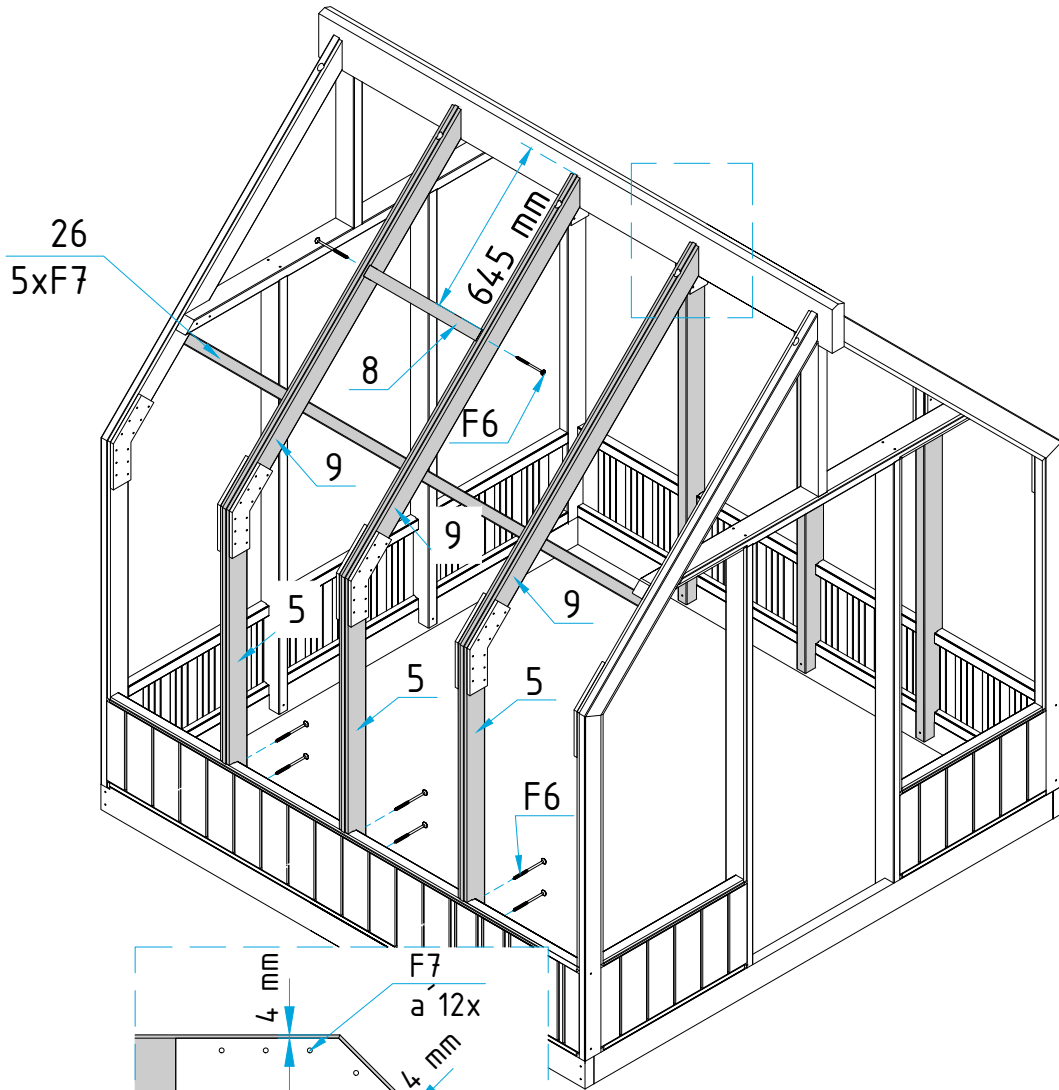

det 101 - 8 pcs

det 20 - 10 pcs

F3 - 10 pcs

F8 - 50 pcs

F20 - 10 pcs 

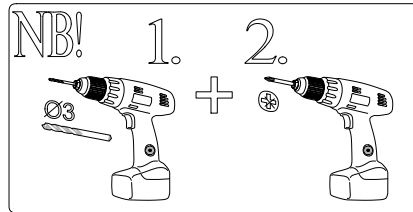

7

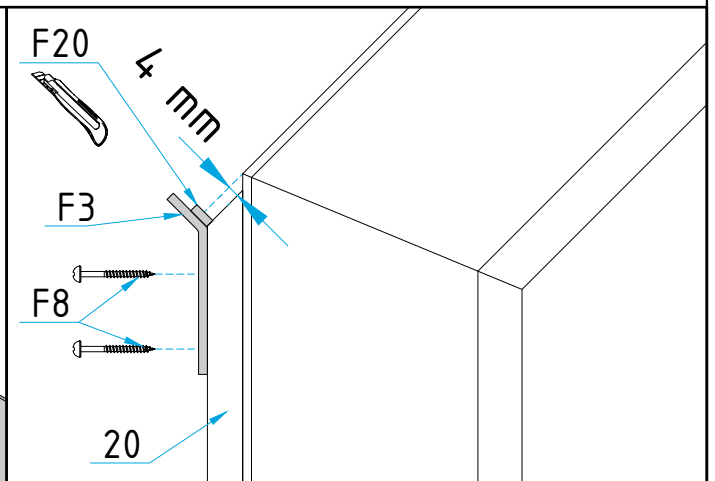
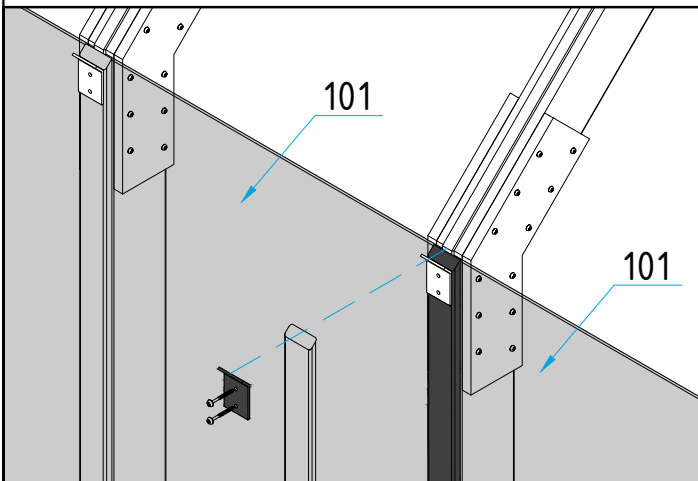
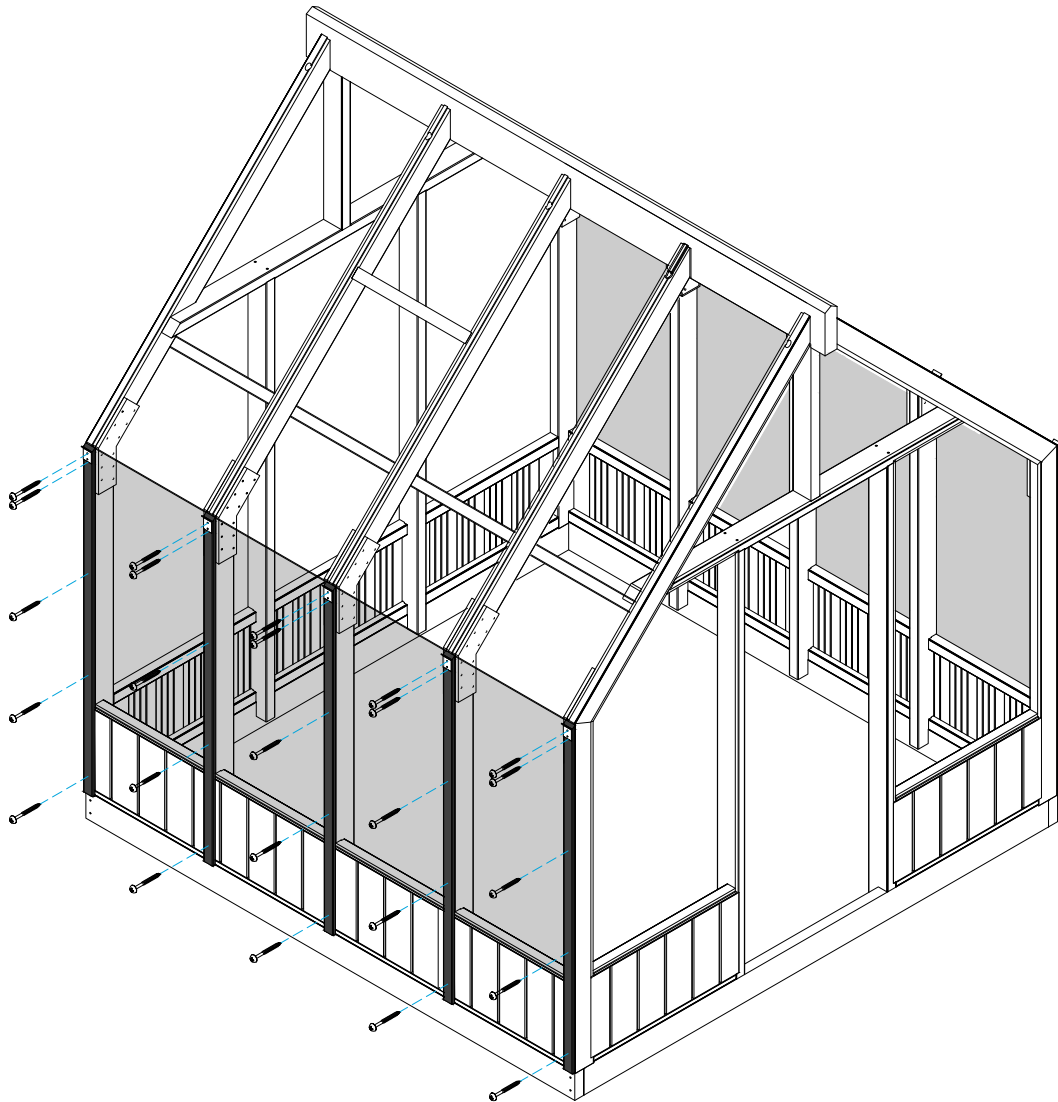

- det 102 - 1 pcs
- det 103 - 1 pcs
- det 24 - 3 pcs
- F8 - 12 pcs

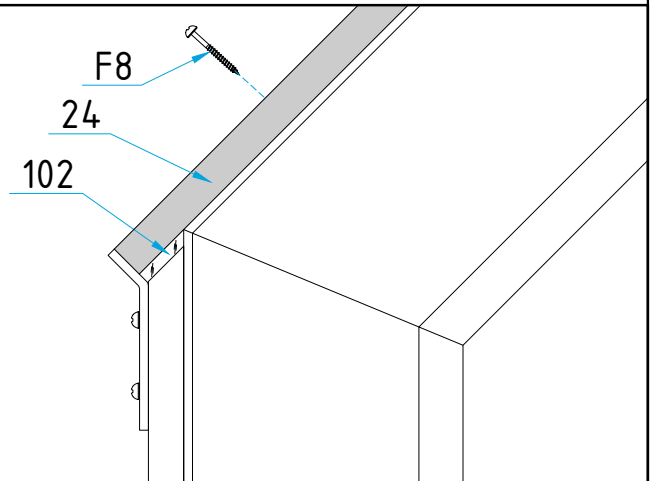
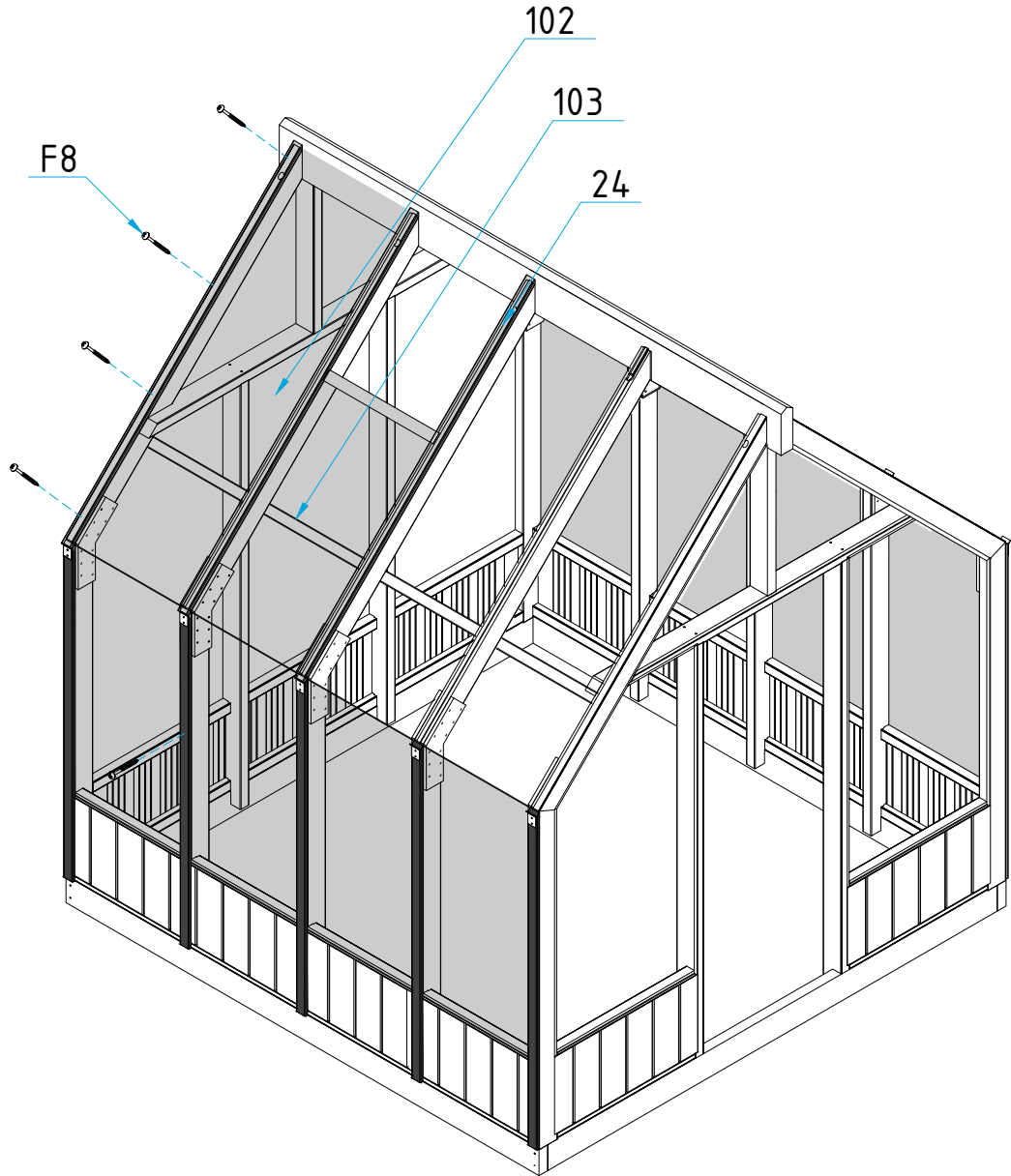
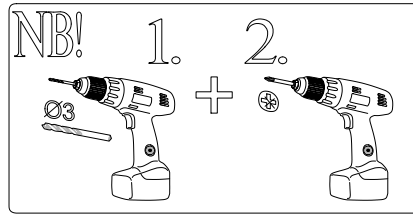

F2

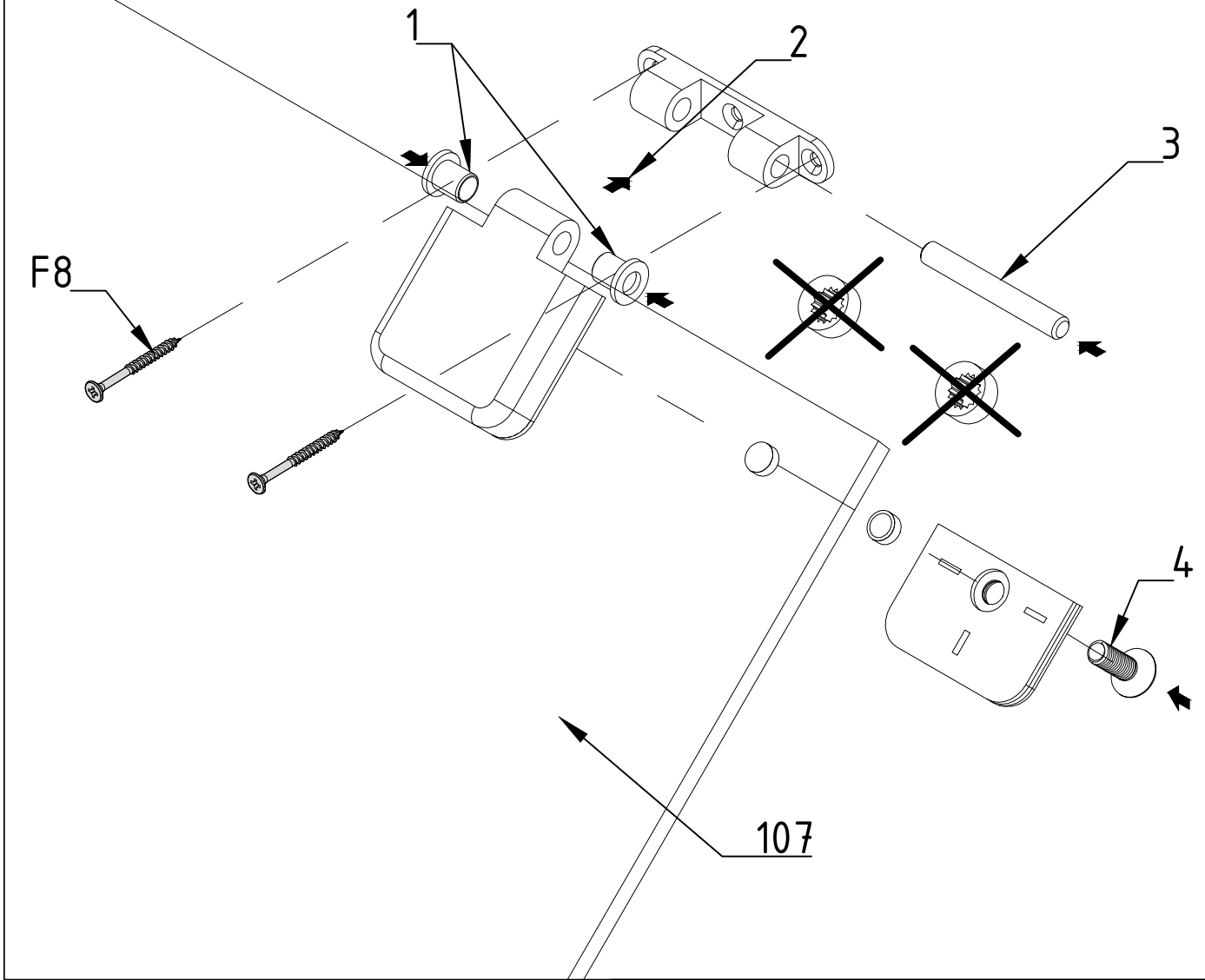

det 107 - 1 pcs

F1 - 1 pcs

F2 - 2 pcs

F8 - 4 pcs

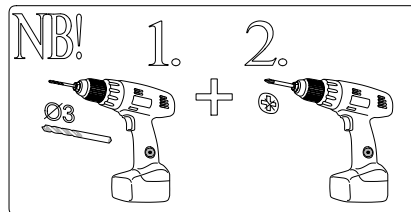

9-2

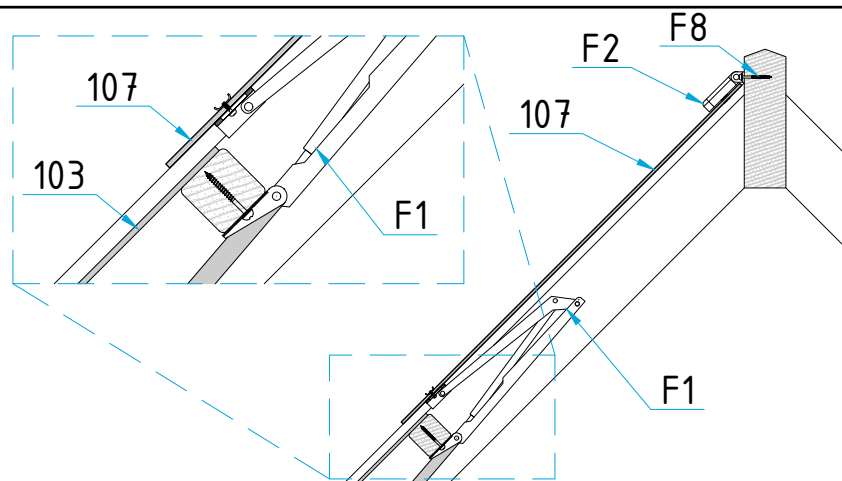
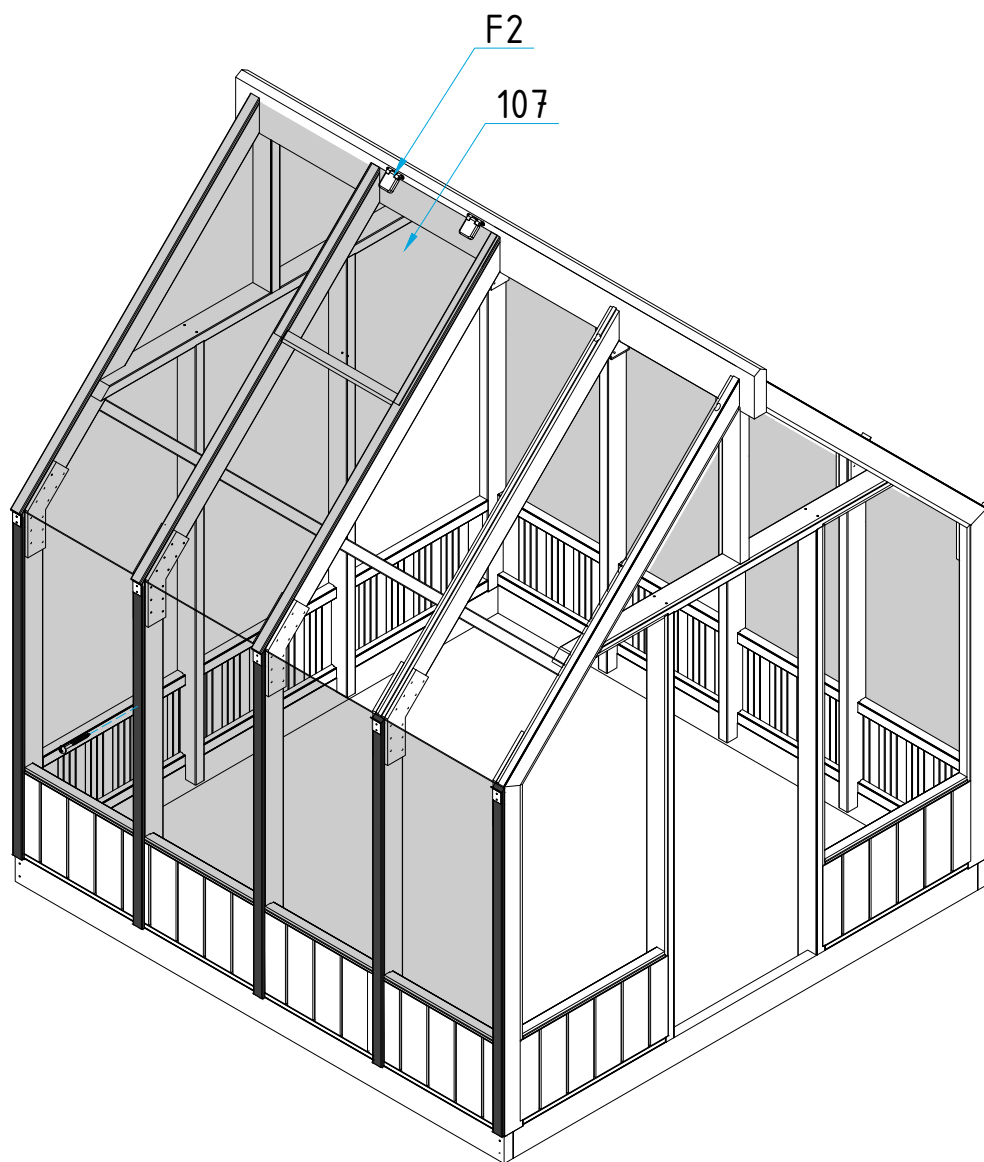

det 102 - 6 pcs
det 24 - 7 pcs
F8 - 28 pcs

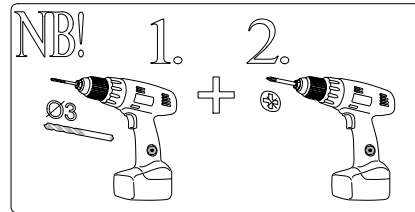

10

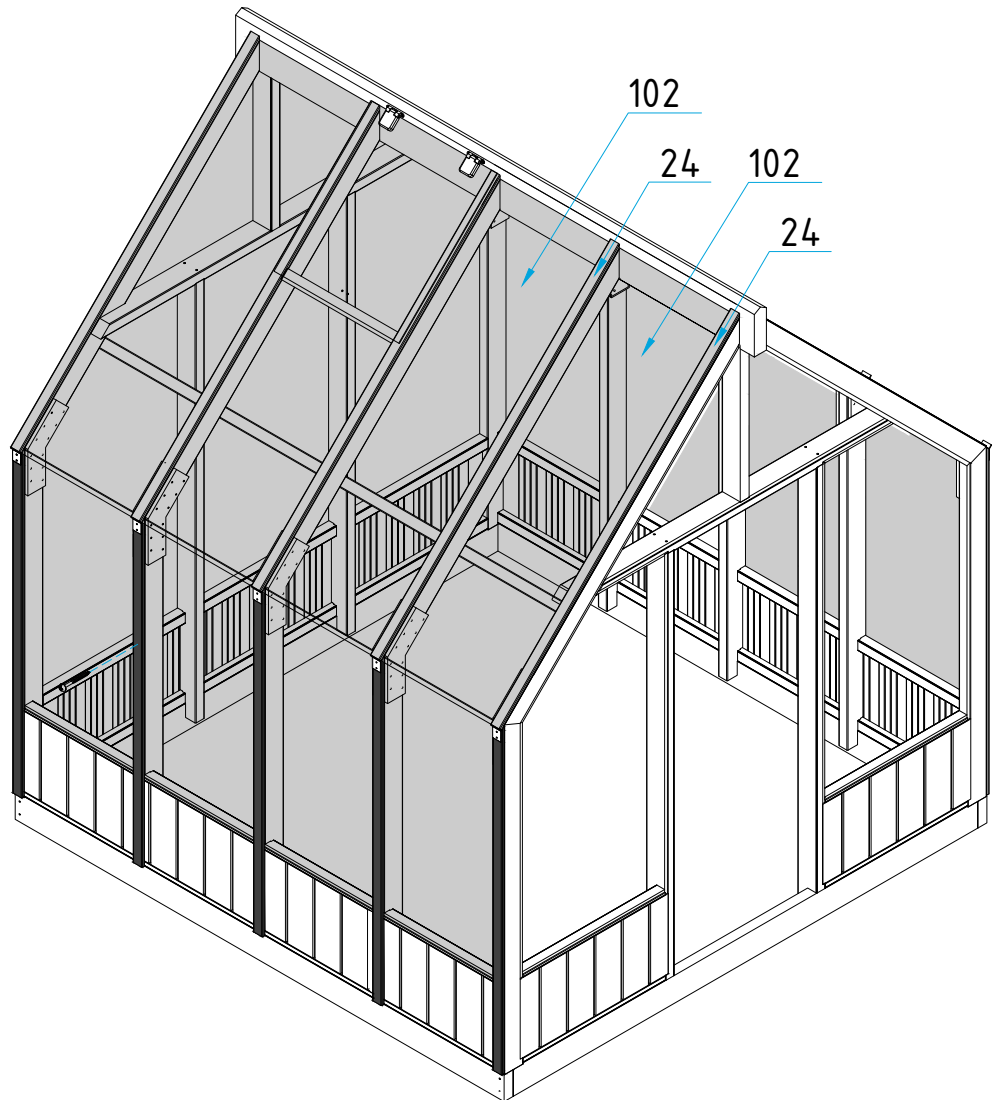

- det 104 - 2 pcs
- det 105 - 1 pcs
- det 106 - 1 pcs
- det 21 - 2 pcs
- det 22 - 2 pcs
- det 23 - 2 pcs
- det 25 - 1 pcs

F8 - 35 pcs

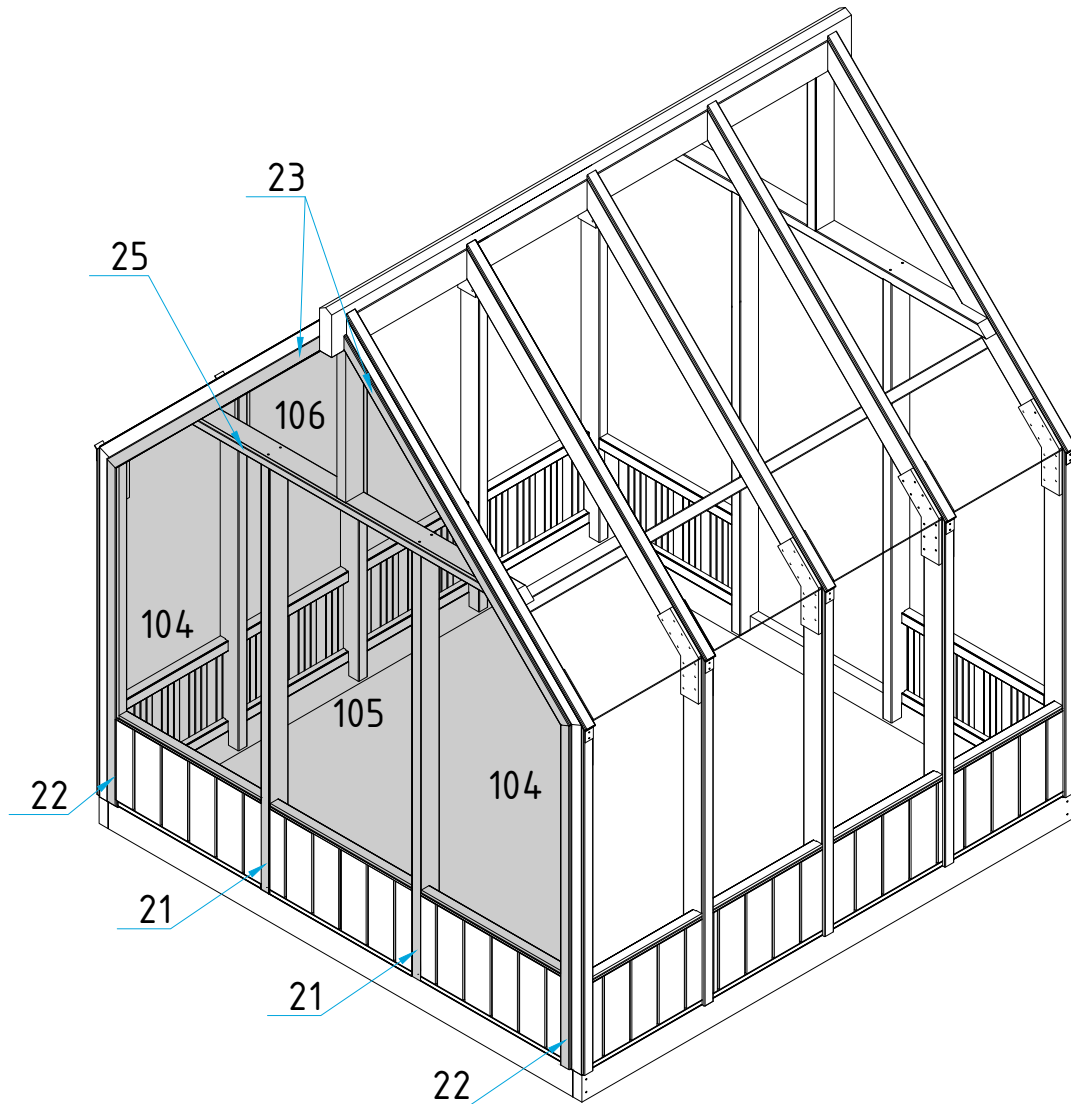
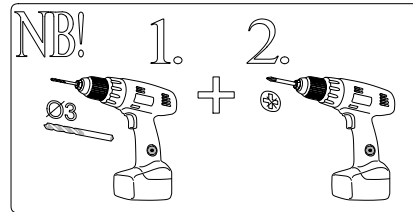

det 104 - 2 pcs
det 106 - 1 pcs
det 21 - 4 pcs
det 22 - 2 pcs
det 23 - 2 pcs
det 25 - 1 pcs

F8 - 65 pcs
F14 - 2 pcs
F15 - 1 pcs

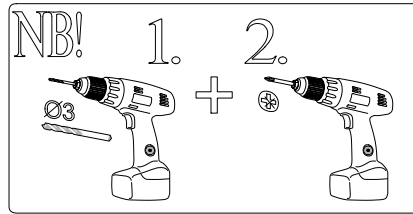

12

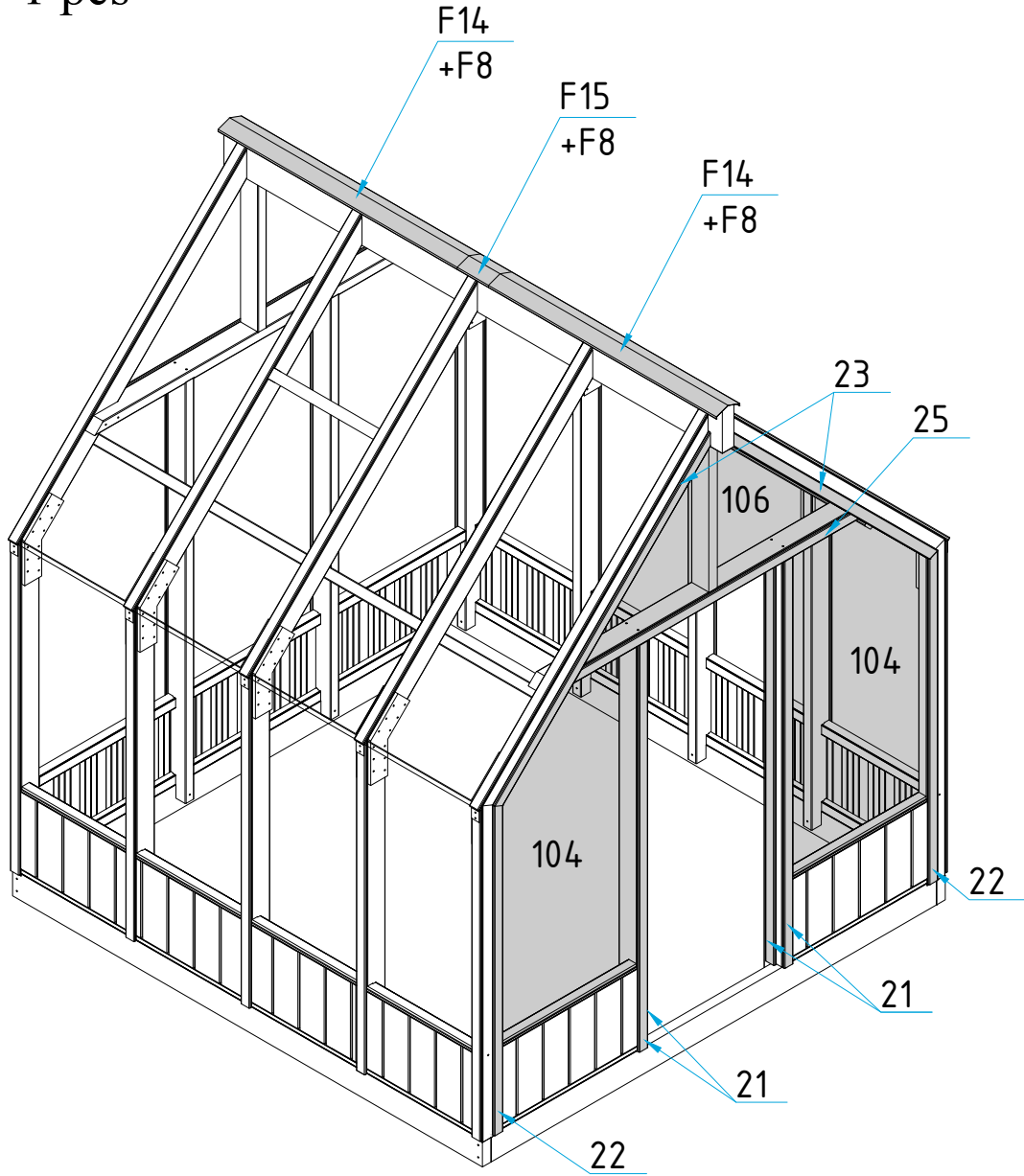

KUL145 - 1 pcs

F4 - 2 pcs

F9 - 6 pcs

F10 - 12 pcs

F16 - 1 pcs

F17 - 1 pcs

F18 - 1 pcs

F19 - 1 pcs

