

Assembly, installation and maintenance manual

Montage-, Aufbau- und Wartungsanleitung • Assemblage, manuel de montage et d'entretien • Montaje, instalación y mantenimiento • Manuale di montaggio, installazione e manutenzione • Monterings- og vedlikeholdsmanual • Monterings-, installations- och underhållsmanual • Kokoamis-, asennus- ja huolto-ohje • Vejledning for montering og vedligehold • Handleiding voor montage, installatie en onderhoud • Manual de montagem, instalação e manutenção • Návod k montáži, instalaci a údržbě • Instrukcja montażu, instalacji i konserwacji • Surinkimo, montavimo ir priežiūros vadovas • Montāžas, uzstādīšanas un apkopes rokasgrāmata • Руководство по сборке и обслуживанию • Montaaži-, paigaldus- ja säilitamise juhend



Pavilion **PA44-2419-2**

<p>Factory inspection by • Werkskontrolle durch • Contrôle à partir de l'usine par • Inspector de fábrica • Collaudato da • Fabrikkontroll utført av • Fabriksbesiktigat av • Tehtaan tarkastaja • Fabriks Kontrol udført af • Fabriekscontrole door • Inspeção de fábrica, por: • Zkontrolováno ve výrobním závodě • Kontrola fabryczna do • Apžiūrą gamykloje atliko • Rūpnīcas pārbaudi veicis • Заводской контроль • Tehase kontroll teostatud:</p> <p>.....</p>	<p>Date • Datum • Date • Fecha • Data • Dato • Datum • Päiväys • Dato • Datum • Data • Datum • Data • Datums • Data • Дата • Kuupäev:</p>
	<p>Pack number • Pack Nr. • Packet n° • Bulto N° • Pacco N. • Serienr • Produktionsnummer • Pakettinro • Pakke nr. • Pak nr. • Número de embalagem • Číslo balení • Numer opakowania • Pakuotės numeris • Iepakojuma numurs • Упаковочный номер • Pakinumber:</p>



www.palmako.ee/information-hub

English: Before installing and using the product, please read the instructions and warranty terms at www.palmako.ee/information-hub to guarantee proper installation and long-lasting performance.

Deutsch: Wichtig! Bitte vor Aufbau und Nutzung des Produkts unbedingt die detaillierte Montageanleitung sowie die Garantiebedingungen unter www.palmako.ee/information-hub lesen, um eine fachgerechte Montage und eine lange Funktionssicherheit zu gewährleisten.

Français: Avant d'installer et d'utiliser le produit, veuillez lire les instructions et les conditions de garantie sur www.palmako.ee/information-hub afin de garantir une installation correcte et la longévité du produit.

Español: Antes de instalar y utilizar el producto, lea las instrucciones y las condiciones de garantía en www.palmako.ee/information-hub para asegurar una instalación correcta y una larga vida útil del producto.

Italiano: Prima di installare e utilizzare il prodotto, leggere le istruzioni e le condizioni di garanzia su www.palmako.ee/information-hub per garantire una corretta installazione e prestazioni durature.

Norsk: Før montering og bruk av produktet, vennligst les monteringsanvisningene og garantivilkårene på www.palmako.ee/information-hub for å sikre korrekt montering og fremtidig holdbarhet.

Svenska: Innan du installerar och använder produkten, vänligen läs instruktionerna och garantivillkoren på www.palmako.ee/information-hub för att säkerställa korrekt installation och produktens långvariga hållbarhet

Suomi: Ennen tuotteen asentamista ja käyttämistä, lue ohjeet ja takuehdot osoitteessa www.palmako.ee/information-hub varmistaaksesi oikean asennuksen ja pitkäkestoisen toiminnan.

Русский: Перед установкой и использованием изделия ознакомьтесь с инструкцией и условиями гарантии на сайте www.palmako.ee/information-hub, чтобы гарантировать правильную установку и долговечность изделия.

Eesti: Enne toote paigaldamist ja kasutuselevõttu lugege palun juhiseid ja garantiitingimusi aadressil www.palmako.ee/information-hub, et tagada nõuetekohane paigaldus ja toote pikk eluiga.

Dansk (Oversat af AI): Læs venligst instruktionerne og garantibetingelserne på www.palmako.ee/information-hub, før du installerer og bruger produktet, for at garantere korrekt installation og langvarig ydeevne.

Dutch (Vertaald door AI): Lees vóór de installatie en het gebruik van het product de instructies en garantievoorwaarden op www.palmako.ee/information-hub om een correcte installatie en langdurige werking te garanderen

Português (Traduzido por IA): Antes de instalar e utilizar o produto, leia as instruções e os termos de garantia em www.palmako.ee/information-hub para garantir uma instalação adequada e um desempenho duradouro.

Čeština (Přeloženo umělou inteligencí): Před instalací a použitím produktu si prosím přečtěte pokyny a záruční podmínky na www.palmako.ee/information-hub, abyste zaručili správnou instalaci a dlouhodobý výkon.

Polski (Przetłumaczone przez AI): Przed zainstalowaniem i użyciem produktu należy przeczytać instrukcję oraz warunki gwarancji dostępne na stronie www.palmako.ee/information-hub, co pozwoli zagwarantować prawidłową instalację i długotrwałą wydajność.

Latviešu (Mākslīgā intelekta tulkojums): Pirms produkta uzstādīšanas un lietošanas, lūdzu, izlasiet instrukcijas un garantijas noteikumus vietnē www.palmako.ee/information-hub, lai garantētu pareizu uzstādīšanu un ilgstošu darbību.









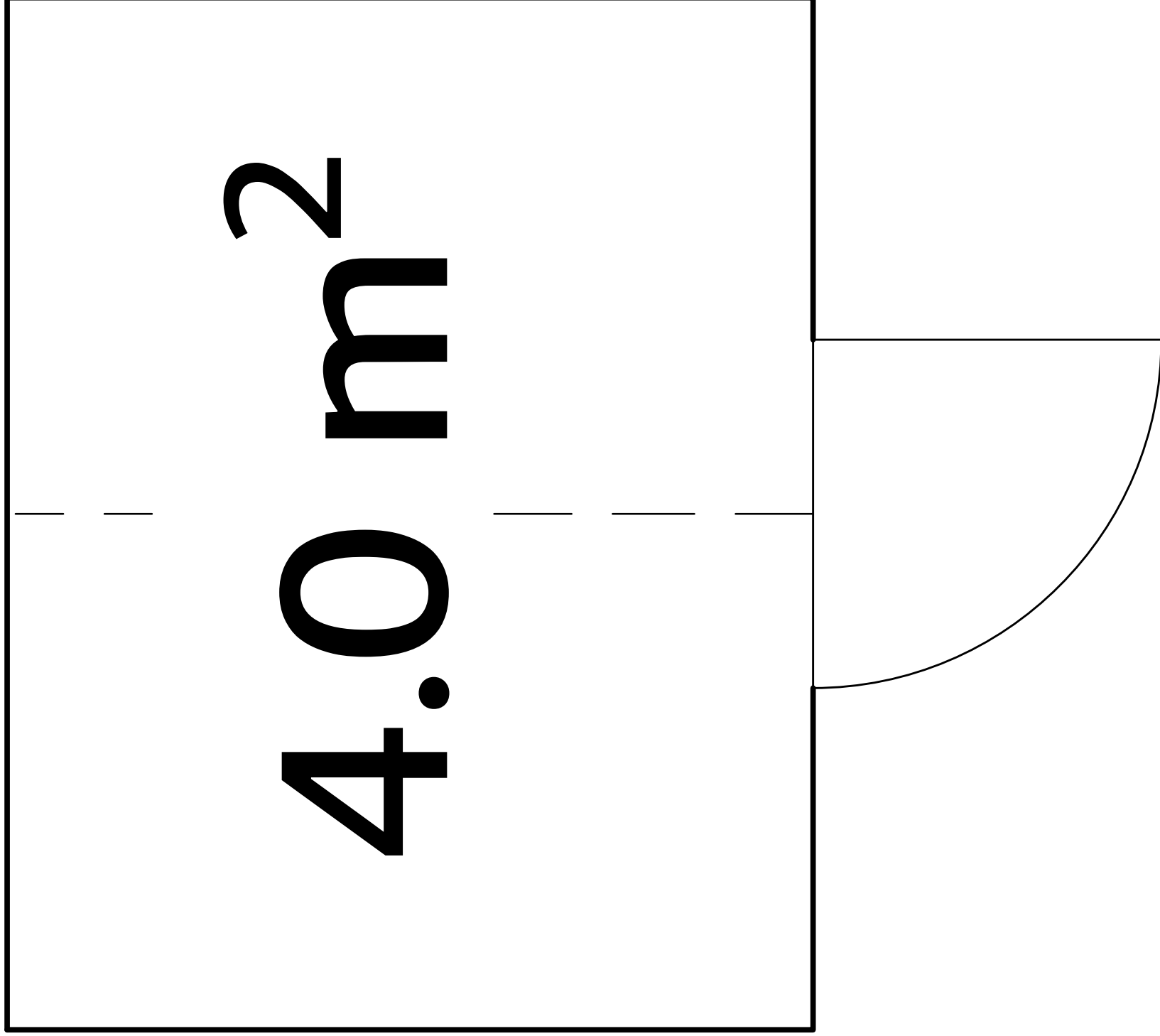

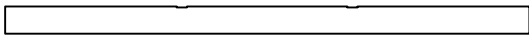

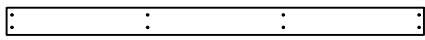

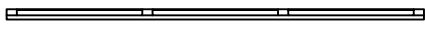

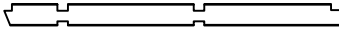

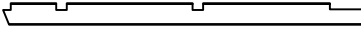

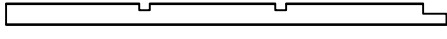

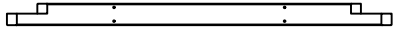

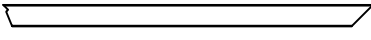

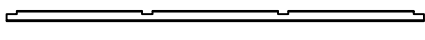

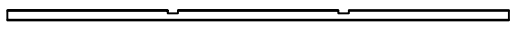

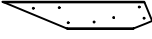

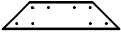



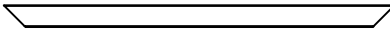

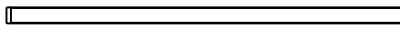



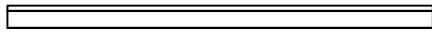



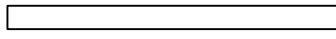

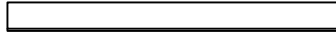
Lietuviškai (Išvertė DI): Prieš montuodami ir naudodami gaminį, perskaitykite instrukcijas ir garantijos sąlygas adresu www.palmako.ee/information-hub, kad užtikrintumėte tinkamą montavimą ir ilgalaikį veikimą.

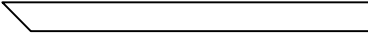
240

4.0 m²

187





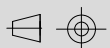



Pos	SPECIFICATION-STÜCKLISTE-NOMENCLATURE-ELEMENTI PA44-2419		Pcs	Profile (mm)	Length (mm)
1			2	45 x 120	2310
2			2	45 x 120	1838
3			2	45 x 45	1838
4			4	44 x 95	1480
5			4	44 x 95	1587
6			4	44 x 95	1940
7			2	44 x 95	1694
8			8	44 x 95	1629
9			6	45 x 45	1838
10			4	45 x 45	2210
11			12	19 x 120	660
12			6	19 x 120	515
13			1	60 x 200	1975
14			4	19 x 95	1722
15			4	19 x 70	1741
16			2	45 x 12	1827
17			38	16 x 98	1874
18			24	18 x 145	1452
19			2	18 x 103	1452
20			2	18 x 125	1452
21			2	18 x 127	1639
22			2	18 x 145	1775
23			2	18 x 145	1911
24			2	18 x 145	2047



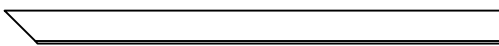
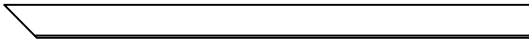

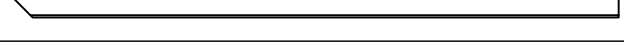
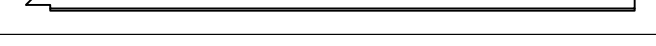
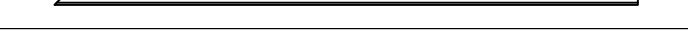
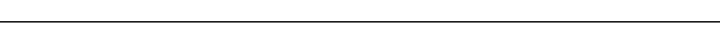
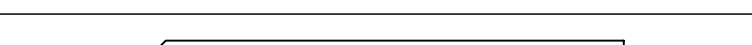
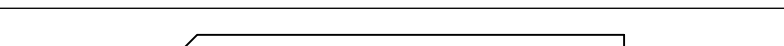
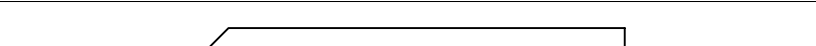
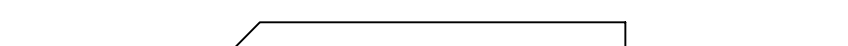
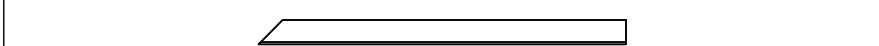
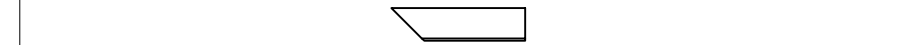
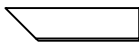
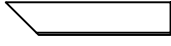

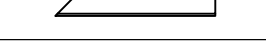
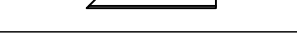
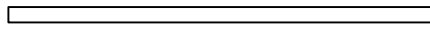



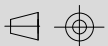

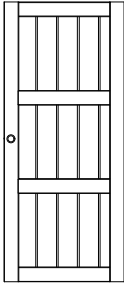
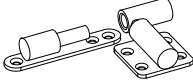

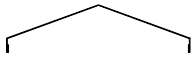
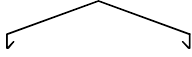
Object name

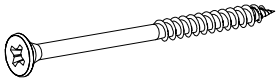
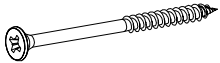
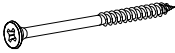
PA44-2419

Page 1 / 3

Pos	SPECIFICATION-STÜCKLISTE-NOMENCLATURE-ELEMENTI PA44-2419	Pcs	Profile (mm)	Length (mm)
25		2	18 x 145	2183
26		2	18 x 145	2319
27		1	18 x 145	2455
28		1	18 x 145	2591
29		1	18 x 145	2682
30		1	18 x 145	2682
31		1	18 x 145	2571
32		1	18 x 145	2435
33		2	18 x 145	2299
34		2	18 x 145	2163
35		2	18 x 145	2027
36		2	18 x 145	1891
37		2	18 x 145	1755
38		2	18 x 106	1619
39		1	18 x 145	590
40		1	18 x 145	726
41		1	18 x 145	817
42		1	18 x 145	817
43		1	18 x 145	706
44		1	18 x 145	570
45		1	18 x 68	1865
46		1	18 x 48	1865
47		2	45 x 12	1594

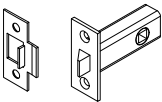

Pos.	Description	Measures (mm)	Pcs
KUL-146		696 x 1818 x 40	1
F1	 QHP15x57Zn	15 x 57	2
F2	 QTA35x100Zn	35 x 100	1
F3		1975 x 200 x 46	1
F4		100 x 201 x 47	1
F5	 QHA150Zn	150 mm	1
F6	 QKRPP6x120ZnTX	Ø 6 X 120	14
F7	 QKRPP5x90ZnTX	Ø 5 X 90	95
F8	 QKRPP4_5x70ZnTX	Ø 4.5 X 70	8
F9	 QKRPP4_5x50RVTx	Ø 4.5 X 50	650
F10	 QKRYP4_2x38RVTX	Ø 4.2 X 38	10
F11	 QKRPP3_5x40ZnTX	Ø 3.5 X 40	40
F12	 QKRPP3_5x25ZnTX	Ø 3.5 X 25	23
F13	 QNA2_2x50Zn	Ø 2.2 X 50	170
F14	 QUNAL		1set
F15	 QRUAu		1set
F16	 QLIKA		1set

Emilia Shed specification 3(3)

det 1 - 2 pcs
det 2 - 2 pcs
F6 - 8 pcs

1

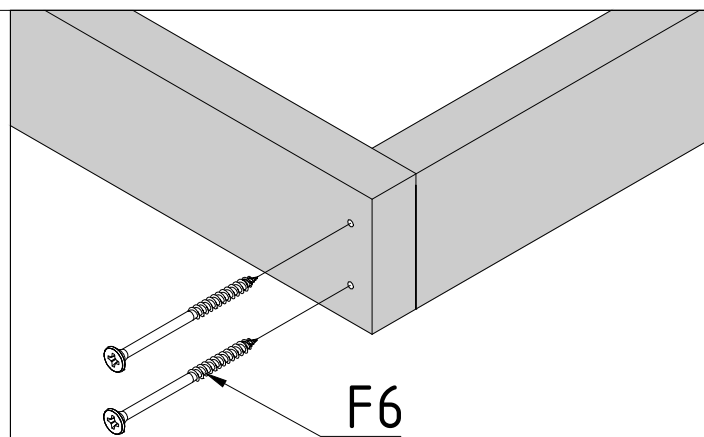
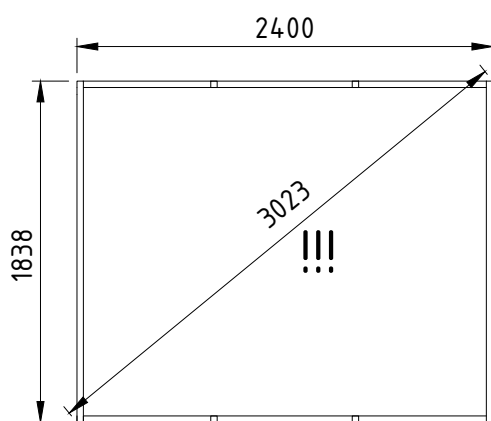
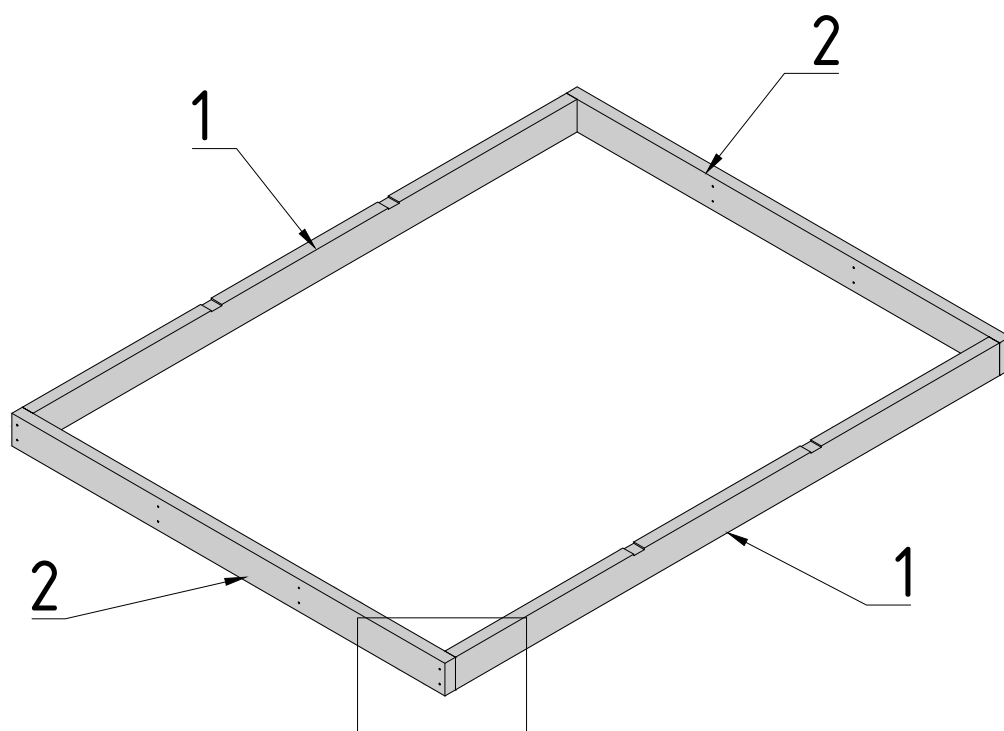

det 3 - 2 pcs
F7 - 12 pcs

2

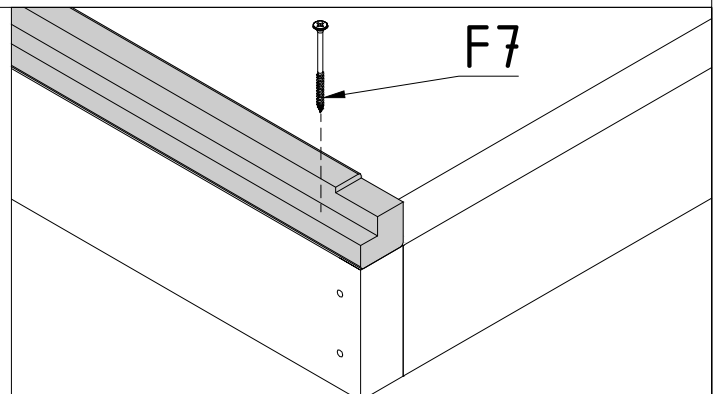
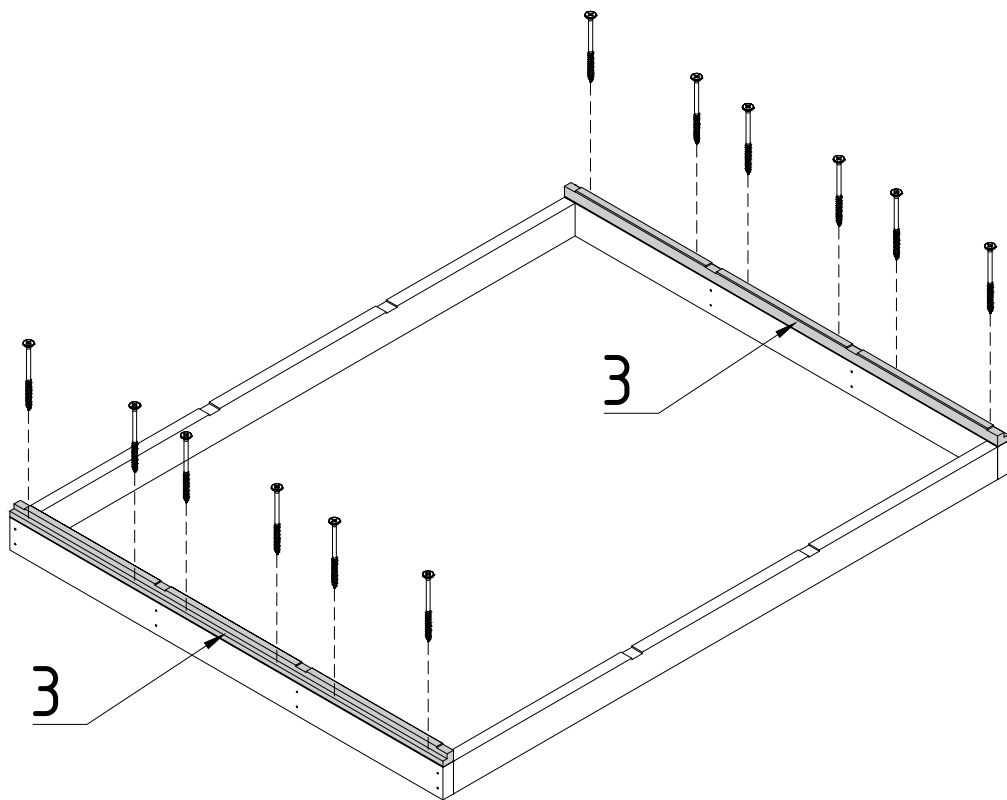

- det 4 - 4 pcs
- det 5 - 4 pcs
- det 6 - 4 pcs
- det 7 - 2 pcs
- det 9 - 6 pcs
- det 10 - 4 pcs
- F7 - 72 pcs

3

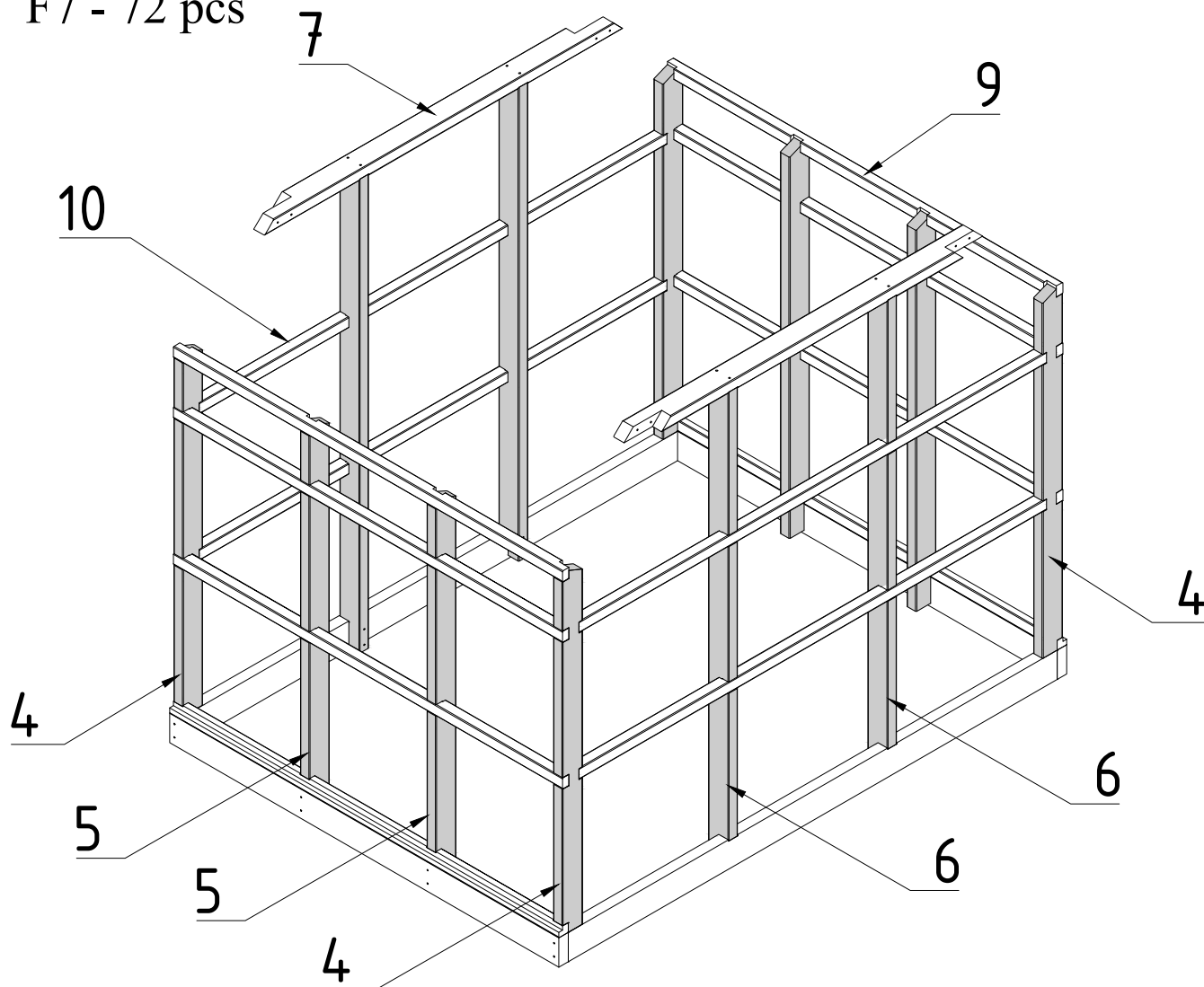

det 8 - 8 pcs
 det 11 - 12 pcs
 det 12 - 6 pcs
 F7 - 8 pcs
 F9 - 132 pcs

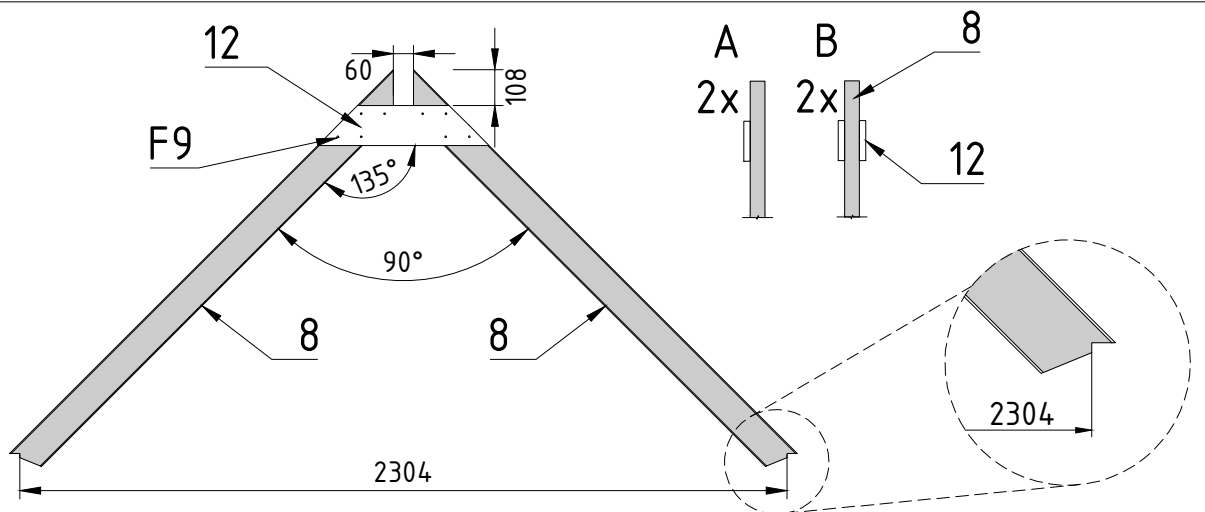
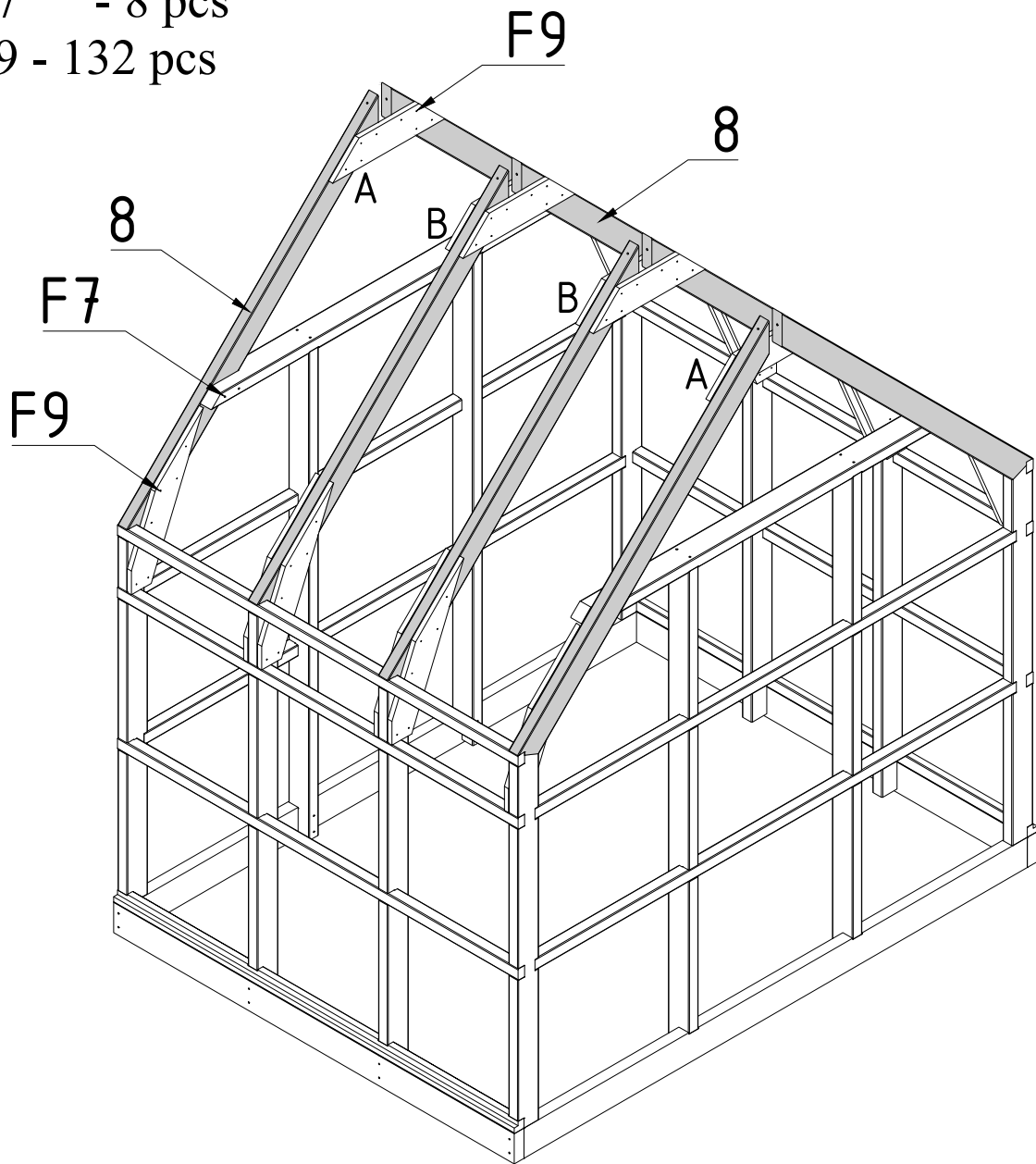

det 13 - 1 pcs
det 18...det 46
F8 - 8 pcs
F9 - 370 pcs
F11 - 10 pcs

5

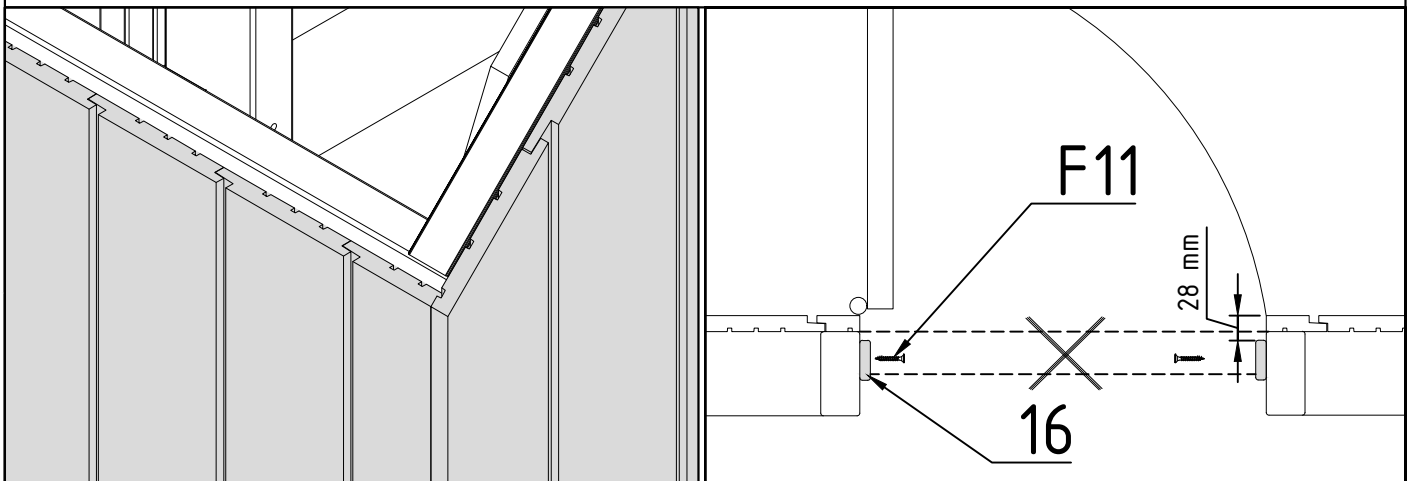
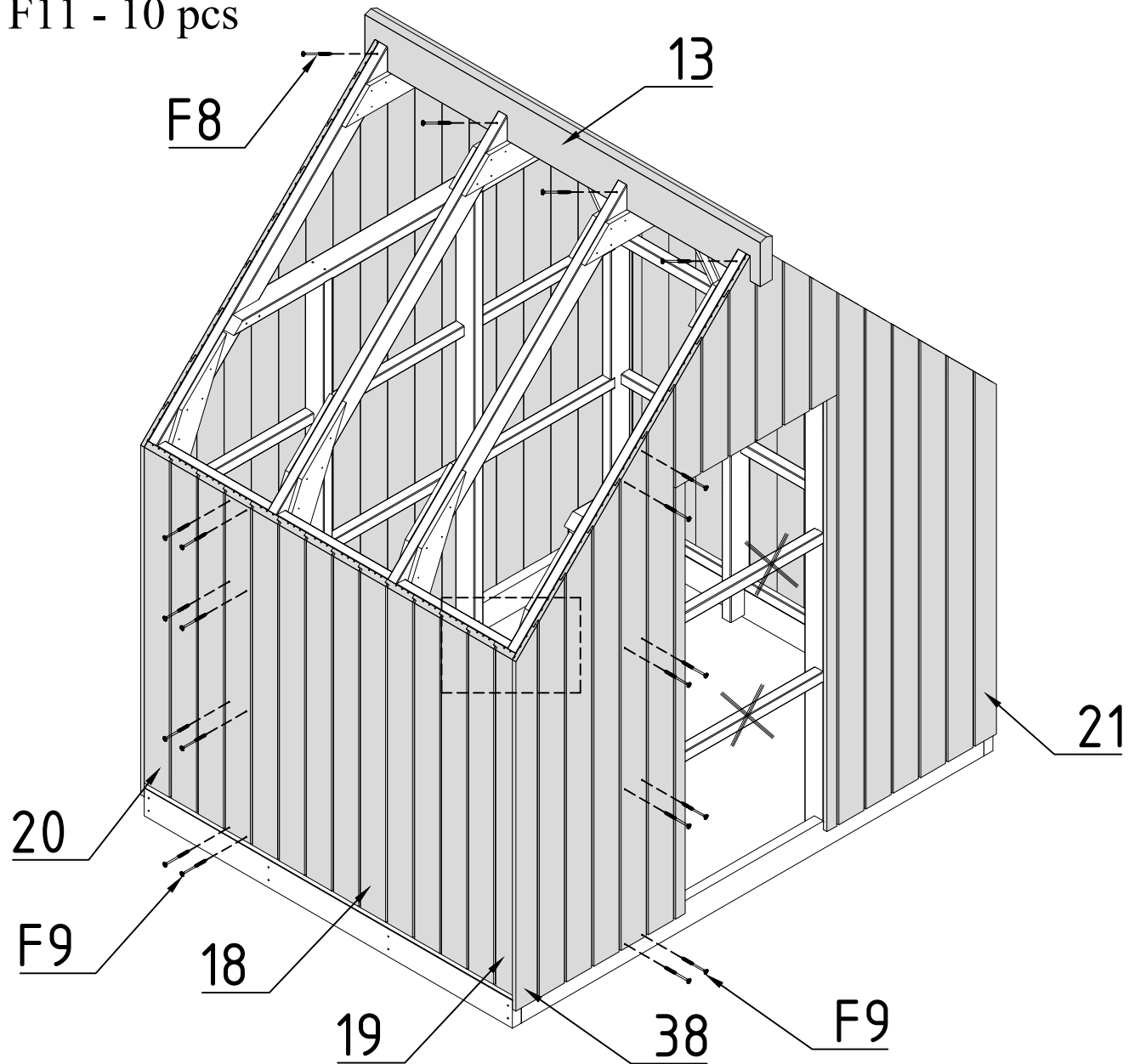

- det 13 - 1 pc
- det 21...det 38
- F6 - 6 pcs
- F8 - 8 pcs
- F9 - 144 pcs

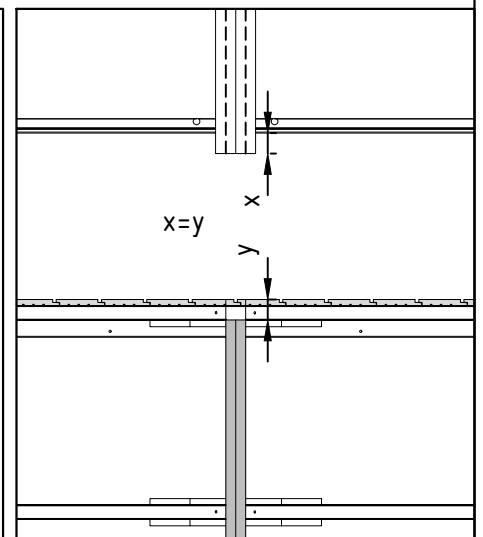
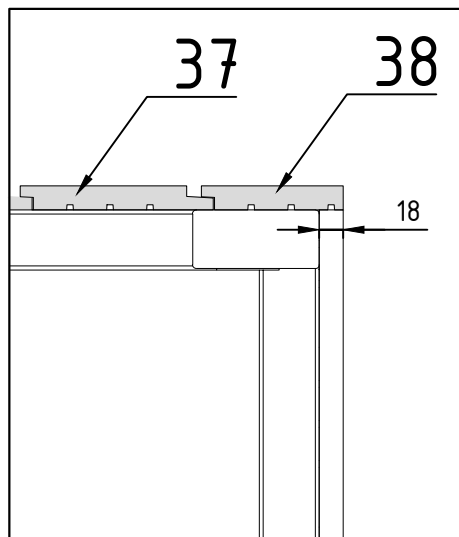
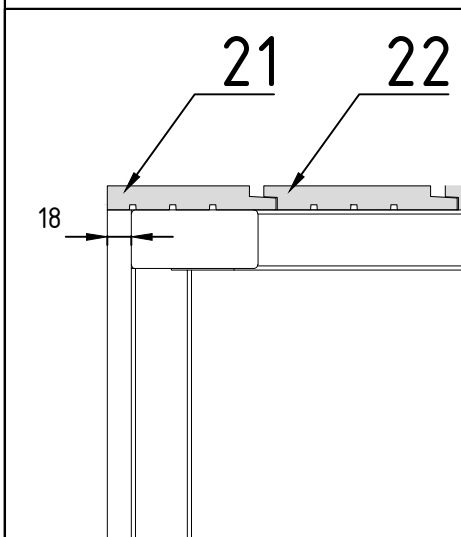
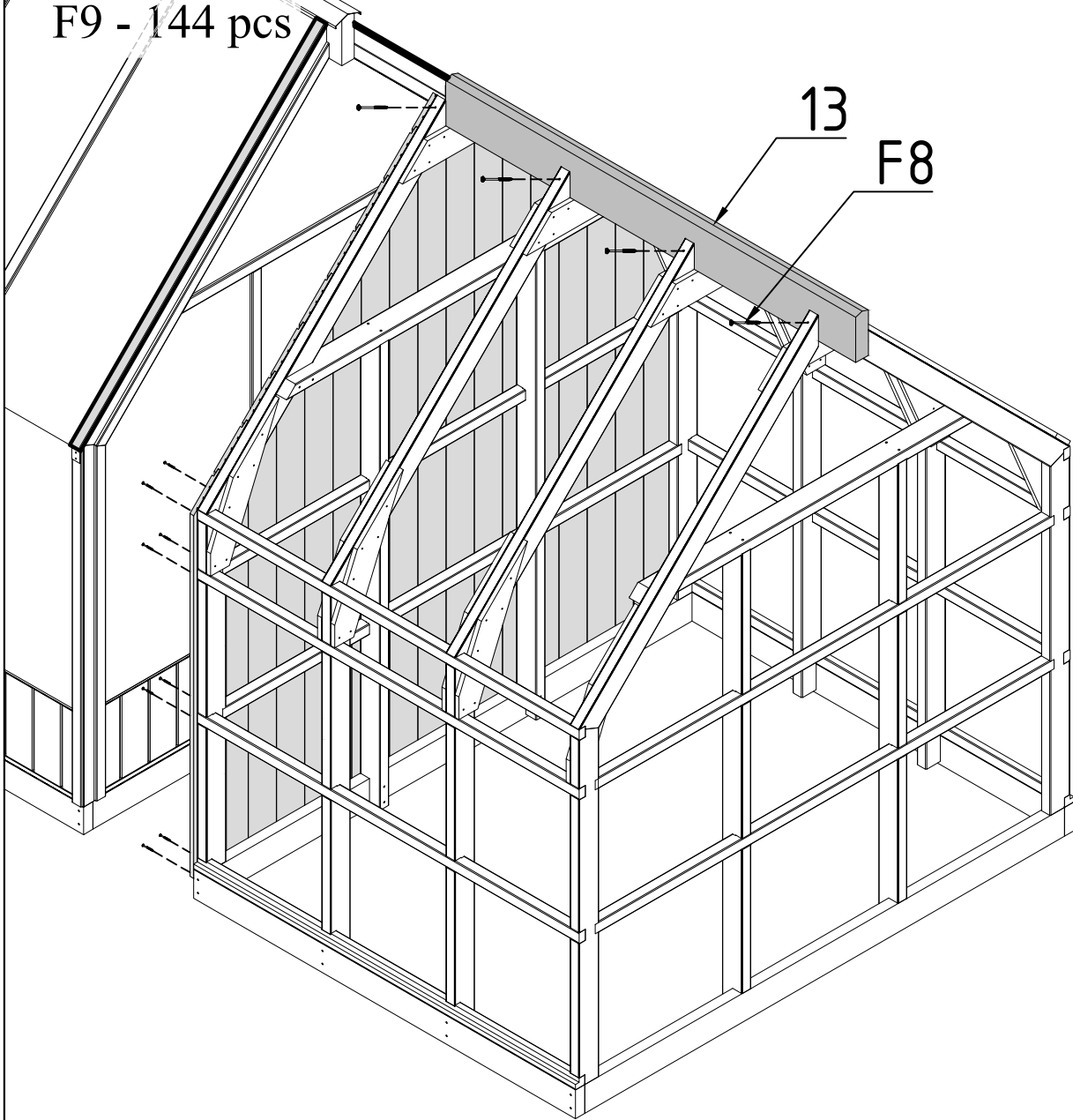

KUL-146 - 1 pcs

det 17 - 38 pcs

F1 - 2 pcs

F5 - 1 pcs

F11 - 4 pcs

F12 - 12 pcs

F13 - 170 pcs

6

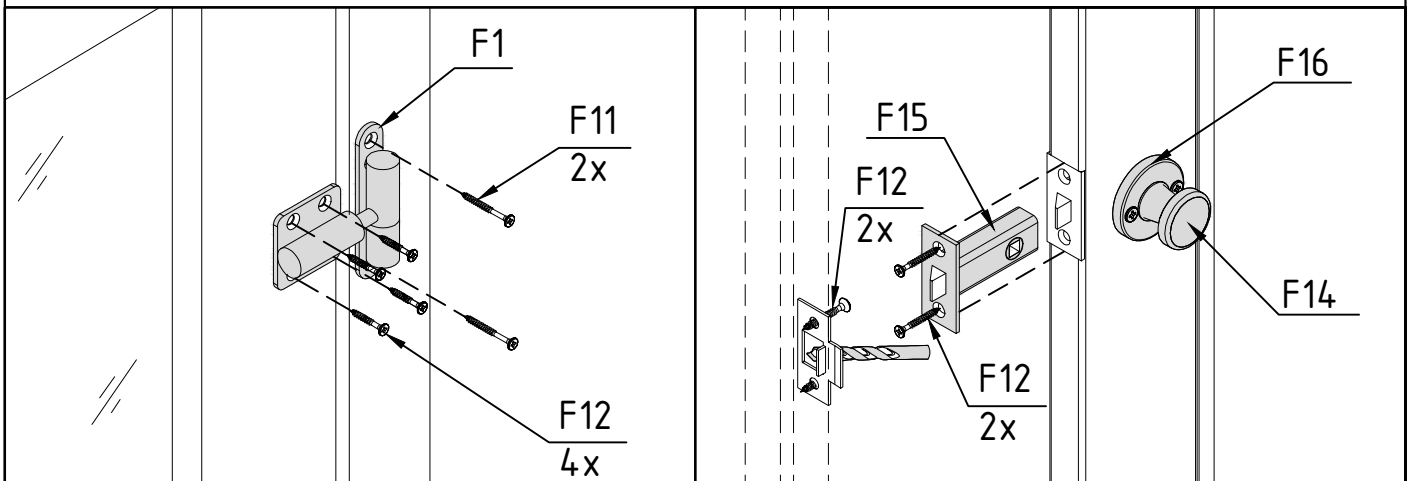
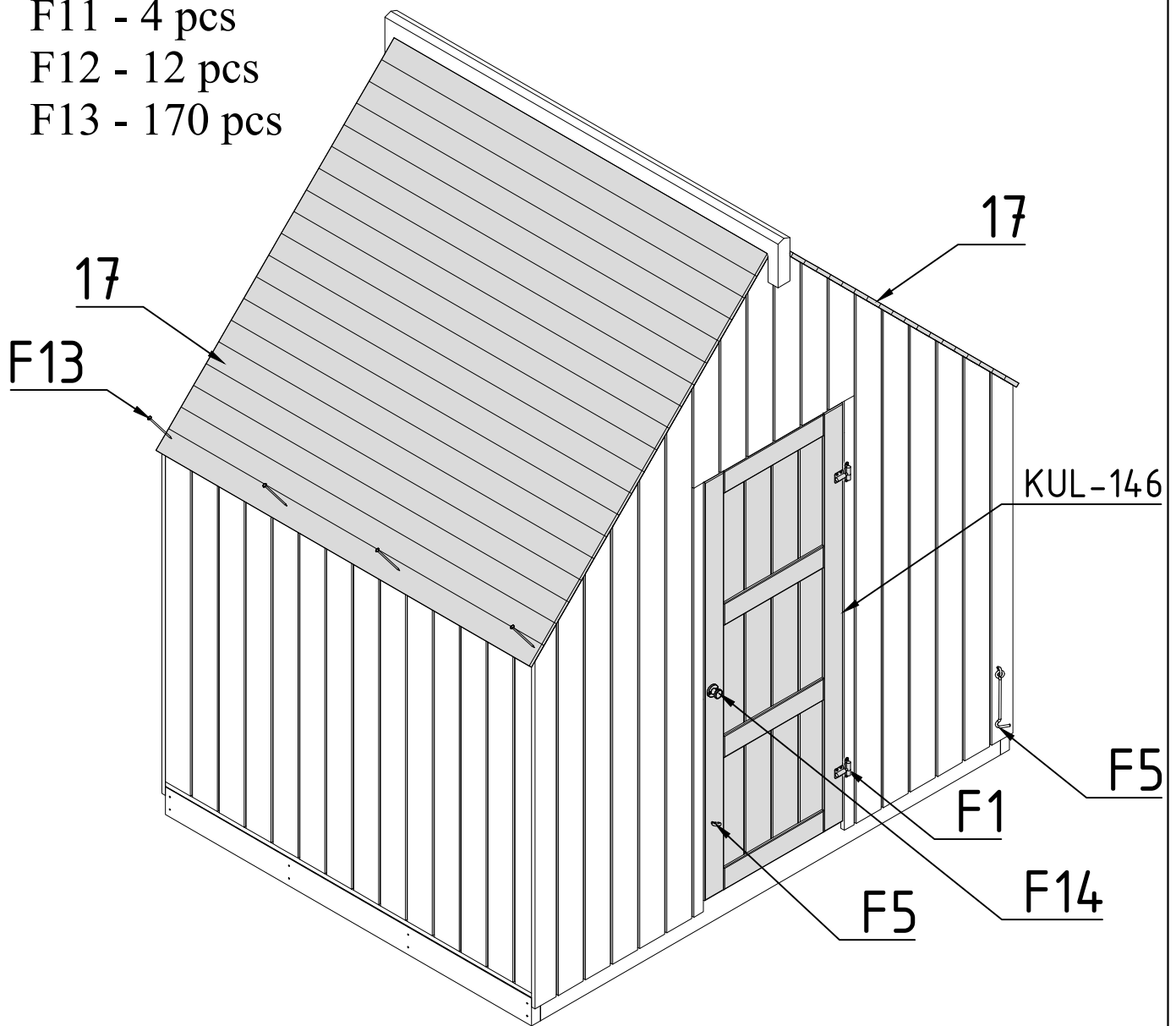

F6 - 6 pcs

6a

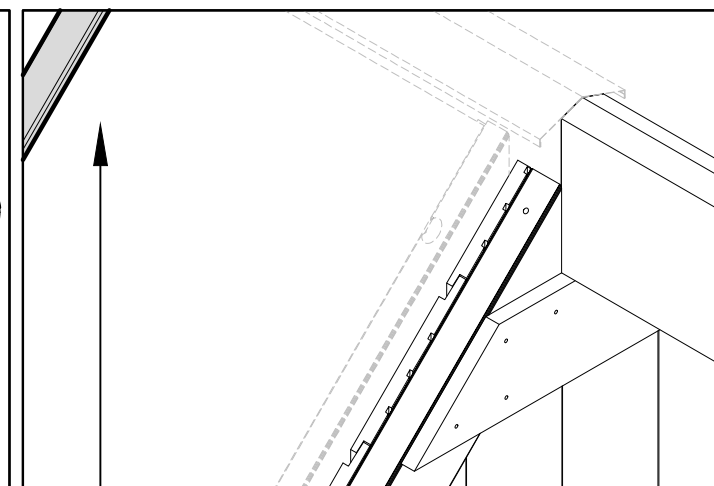
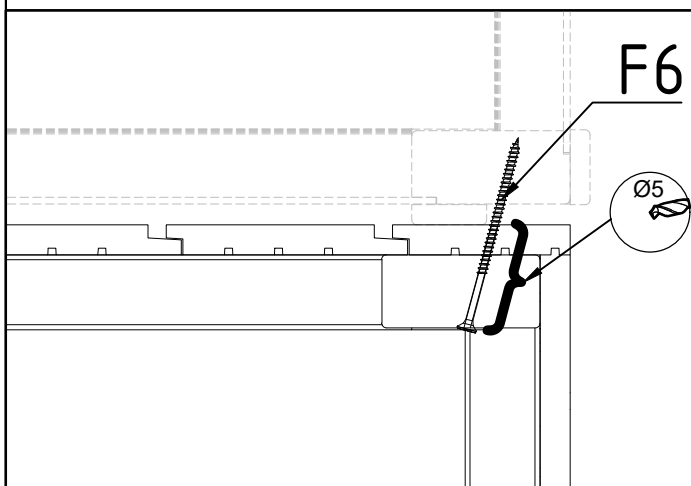
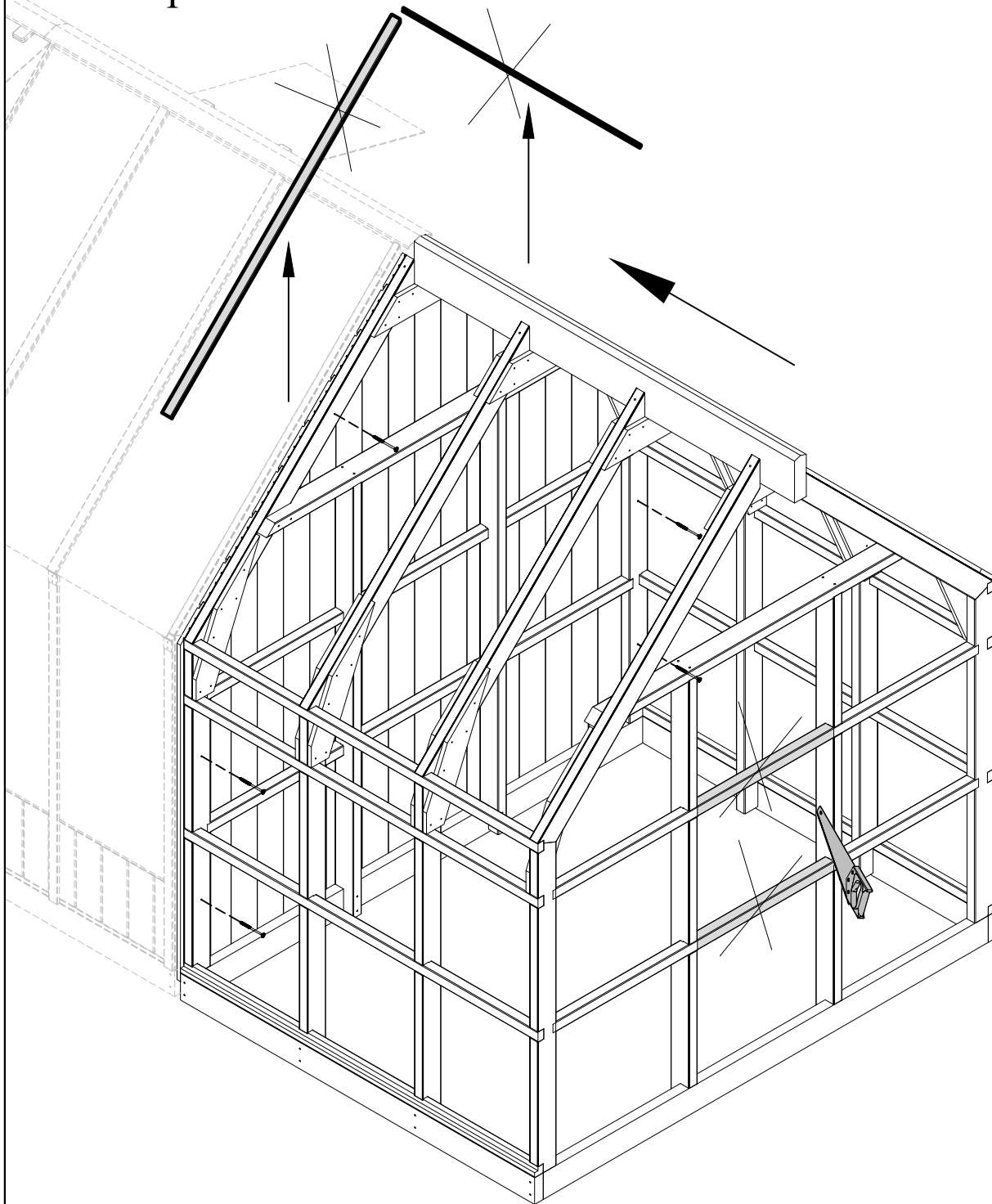

- det 14 - 4 pcs
- det 15 - 4 pcs
- F2 - 1 pcs
- F3 - 1 pcs
- F9 - 32 pcs
- F10 - 10 pcs
- F12 - 7 pcs

7

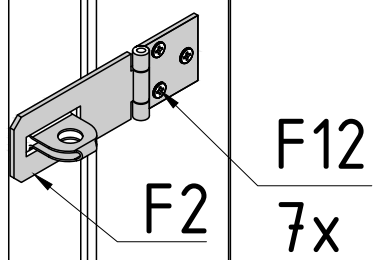
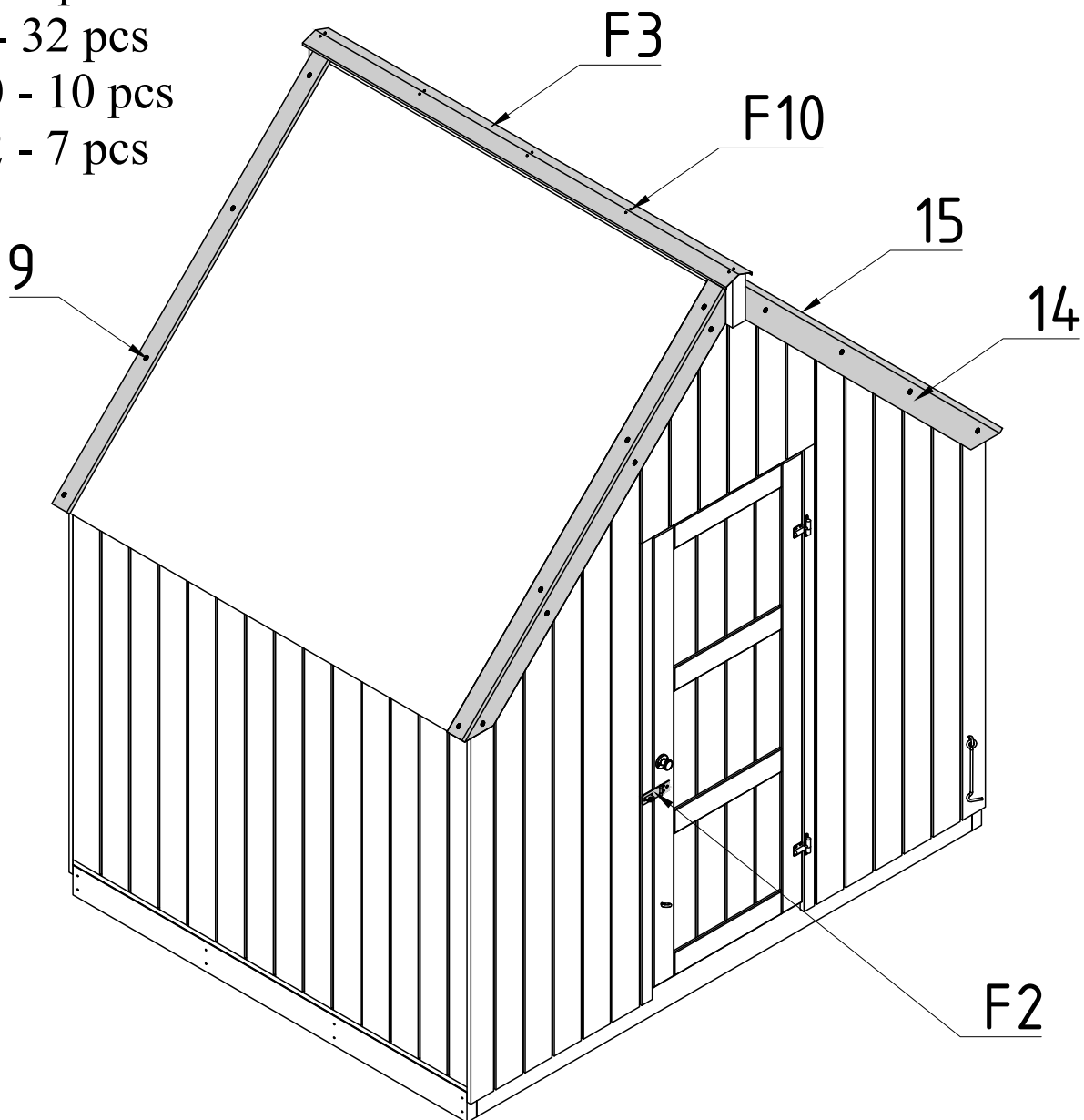

det 16 - 2 pcs
det 21...det 38
F9 - 336 pcs
F11 - 10 pcs

7a

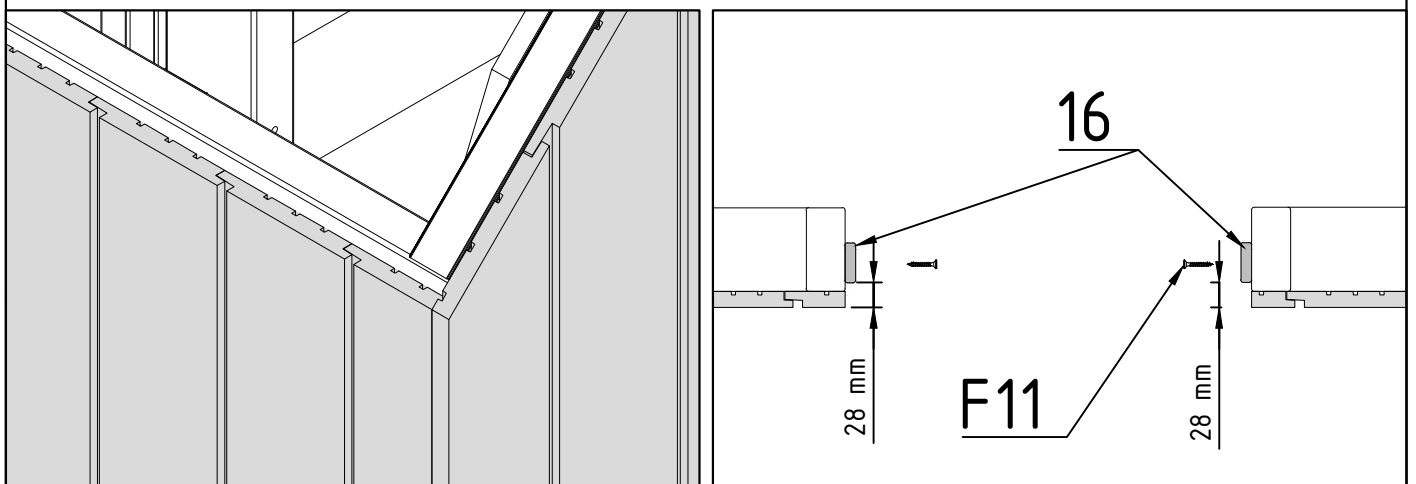
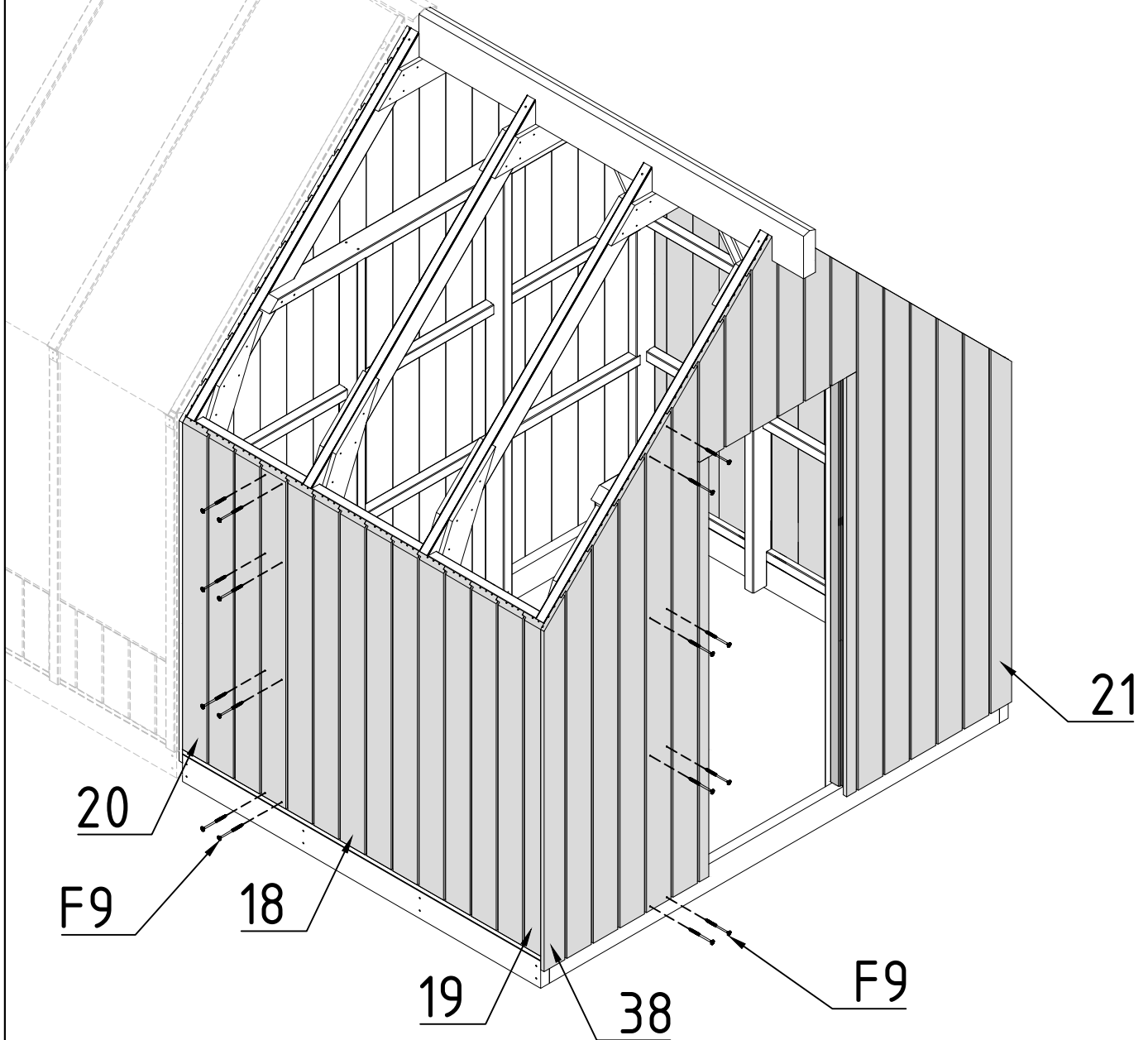

- KUL-146 - 1 pc
- det 17 - 38 pcs
- F1 - 2 pcs
- F11 - 6 pcs
- F12 - 12 pcs
- F13 - 170 pcs
- F14 - 1 pc
- F15 - 1 pc
- F16 - 1 pc

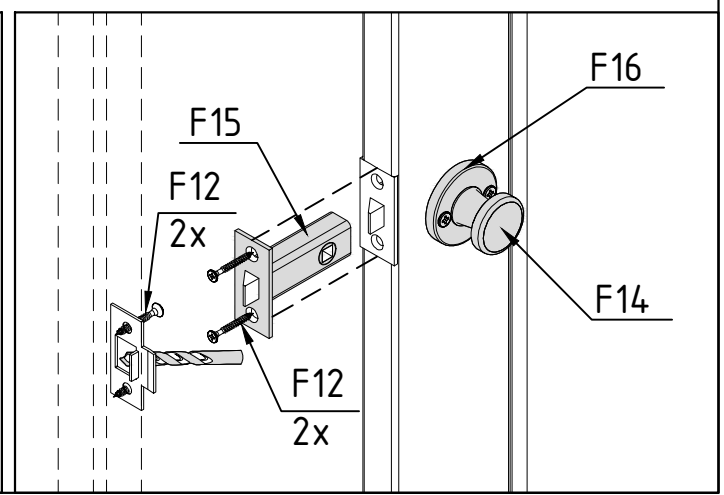
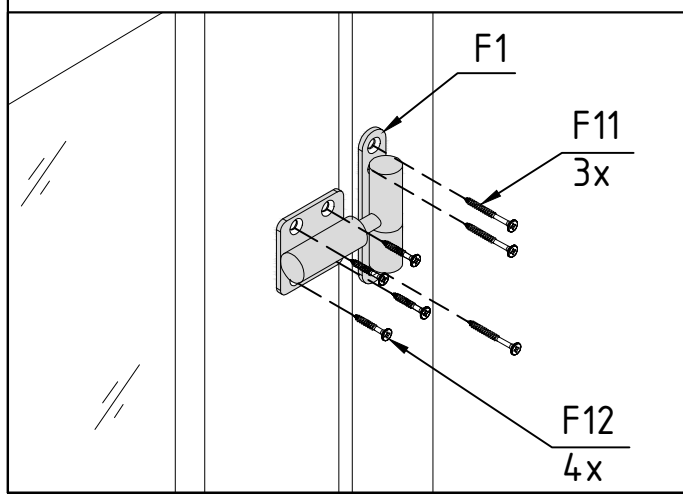
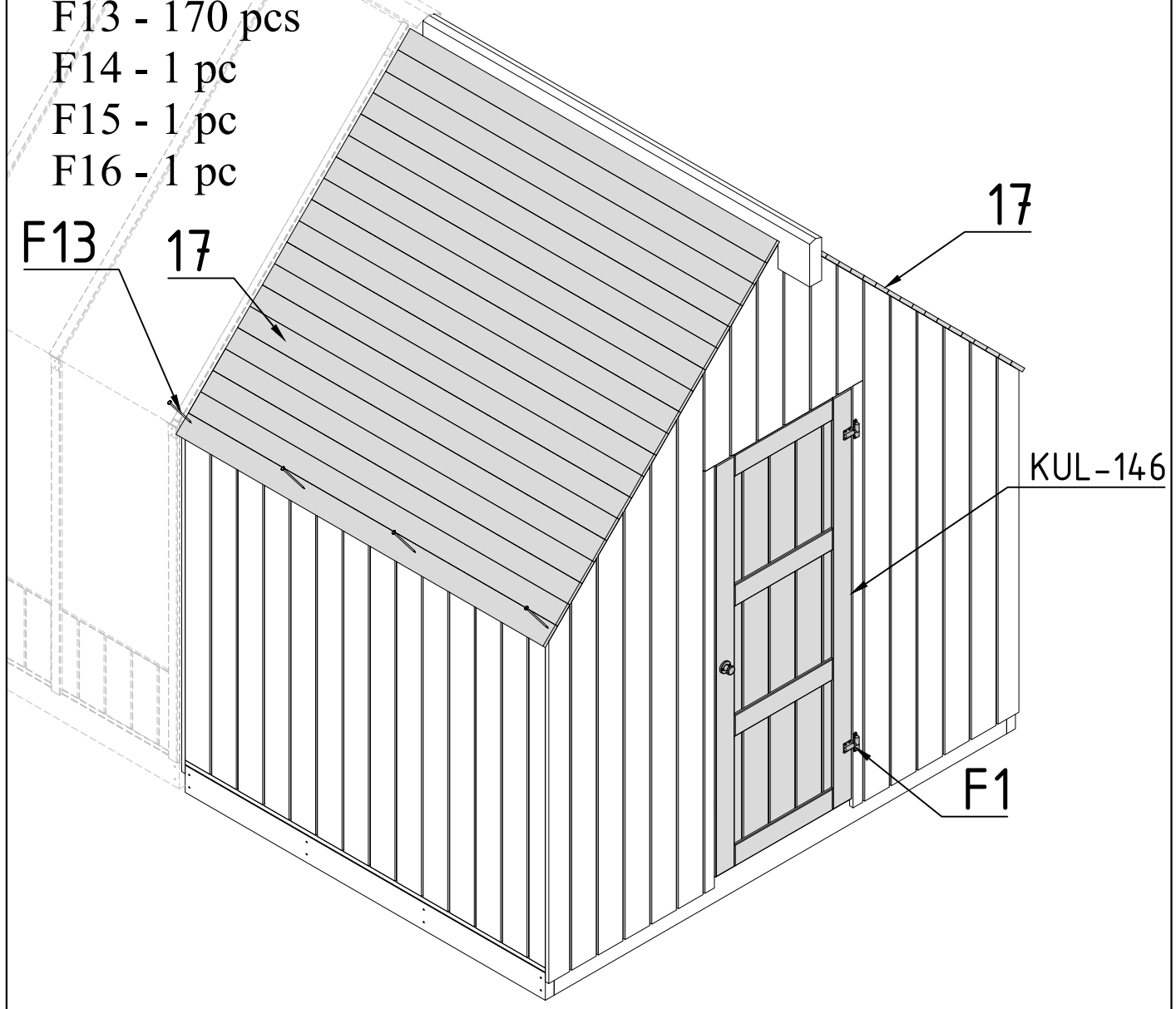

9a

det 14 - 4 pcs (2 pcs)

det 15 - 4 pcs

F2 - 1 pc

F3 - 1 pc

F5 - 1 pc

F9 - 32 pcs

F10 - 10 pcs

F12 - 7 pcs

