

Assembly, installation and maintenance manual

Montage-, Aufbau- und Wartungsanleitung • Assemblage, manuel de montage et d'entretien • Montaje, instalación y mantenimiento • Manuale di montaggio, installazione e manutenzione • Monterings- og vedlikeholdsmanual • Monterings-, installations- och underhållsmanual • Kokoamis-, asennus- ja huolto-ohje • Vejledning for montering og vedligehold • Handleiding voor montage, installatie en onderhoud • Manual de montagem, instalação e manutenção • Návod k montáži, instalaci a údržbě • Instrukcja montażu, instalacji i konserwacji • Surinkimo, montavimo ir priežiūros vadovas • Montāžas, uzstādīšanas un apkopes rokasgrāmata • Руководство по сборке и обслуживанию • Montaaži-, paigaldus- ja säilitamise juhend



Element house **EL18-5634-1**

<p>Factory inspection by • Werkskontrolle durch • Contrôle à partir de l'usine par • Inspector de fábrica • Collaudato da • Fabrikkontroll utført av • Fabriksbesiktigat av • Tehtaan tarkastaja • Fabriks Kontrol udført af • Fabriekscontrole door • Inspeção de fábrica, por: • Zkontrolováno ve výrobním závodě • Kontrola fabryczna do • Apžiūrą gamykloje atliko • Rūpnīcas pārbaudi veicis • Заводской контроль • Tehase kontroll teostatud:</p> <p>.....</p>	<p>Date • Datum • Date • Fecha • Data • Dato • Datum • Päiväys • Dato • Datum • Data • Datum • Data • Datums • Data • Дата • Kuupäev:</p> <hr/> <p>Pack number • Pack Nr. • Packet n° • Bulto N° • Pacco N. • Serienr • Produktionsnummer • Pakettinro • Pakke nr. • Pak nr. • Número de embalagem • Číslo balení • Numer opakowania • Pakuotės numeris • Iepakojuma numurs • Упаковочный номер • Pakinumber:</p>
---	---



www.palmako.ee/information-hub

English: Before installing and using the product, please read the instructions and warranty terms at www.palmako.ee/information-hub to guarantee proper installation and long-lasting performance.

Deutsch: Wichtig! Bitte vor Aufbau und Nutzung des Produkts unbedingt die detaillierte Montageanleitung sowie die Garantiebedingungen unter www.palmako.ee/information-hub lesen, um eine fachgerechte Montage und eine lange Funktionssicherheit zu gewährleisten.

Français: Avant d'installer et d'utiliser le produit, veuillez lire les instructions et les conditions de garantie sur www.palmako.ee/information-hub afin de garantir une installation correcte et la longévité du produit.

Español: Antes de instalar y utilizar el producto, lea las instrucciones y las condiciones de garantía en www.palmako.ee/information-hub para asegurar una instalación correcta y una larga vida útil del producto.

Italiano: Prima di installare e utilizzare il prodotto, leggere le istruzioni e le condizioni di garanzia su www.palmako.ee/information-hub per garantire una corretta installazione e prestazioni durature.

Norsk: Før montering og bruk av produktet, vennligst les monteringsanvisningene og garantivilkårene på www.palmako.ee/information-hub for å sikre korrekt montering og fremtidig holdbarhet.

Svenska: Innan du installerar och använder produkten, vänligen läs instruktionerna och garantivillkoren på www.palmako.ee/information-hub för att säkerställa korrekt installation och produktens långvariga hållbarhet

Suomi: Ennen tuotteen asentamista ja käyttämistä, lue ohjeet ja takuehdot osoitteessa www.palmako.ee/information-hub varmistaaksesi oikean asennuksen ja pitkäkestoisen toiminnan.

Русский: Перед установкой и использованием изделия ознакомьтесь с инструкцией и условиями гарантии на сайте www.palmako.ee/information-hub, чтобы гарантировать правильную установку и долговечность изделия.

Eesti: Enne toote paigaldamist ja kasutuselevõttu lugege palun juhiseid ja garantiitingimusi aadressil www.palmako.ee/information-hub, et tagada nõuetekohane paigaldus ja toote pikk eluiga.

Dansk (Oversat af AI): Læs venligst instruktionerne og garantibetingelserne på www.palmako.ee/information-hub, før du installerer og bruger produktet, for at garantere korrekt installation og langvarig ydeevne.

Dutch (Vertaald door AI): Lees vóór de installatie en het gebruik van het product de instructies en garantievoorwaarden op www.palmako.ee/information-hub om een correcte installatie en langdurige werking te garanderen

Português (Traduzido por IA): Antes de instalar e utilizar o produto, leia as instruções e os termos de garantia em www.palmako.ee/information-hub para garantir uma instalação adequada e um desempenho duradouro.

Čeština (Přeloženo umělou inteligencí): Před instalací a použitím produktu si prosím přečtěte pokyny a záruční podmínky na www.palmako.ee/information-hub, abyste zaručili správnou instalaci a dlouhodobý výkon.





Polski (Przetłumaczone przez AI): Przed zainstalowaniem i użyciem produktu należy przeczytać instrukcję oraz warunki gwarancji dostępne na stronie www.palmako.ee/information-hub, co pozwoli zagwarantować prawidłową instalację i długotrwałą wydajność.

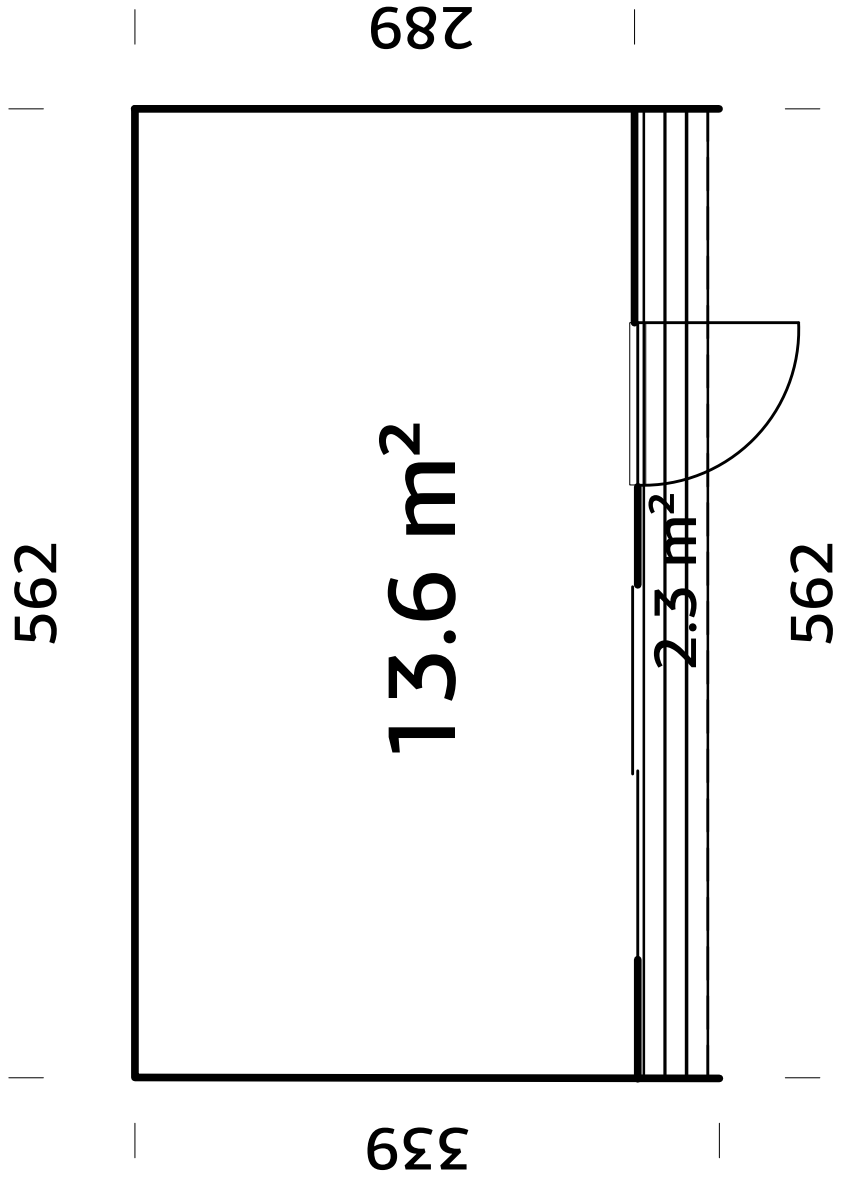

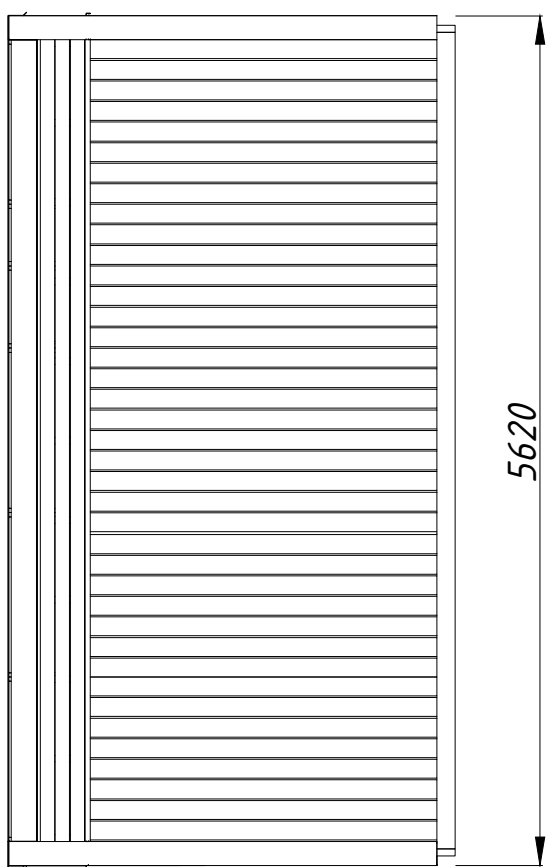
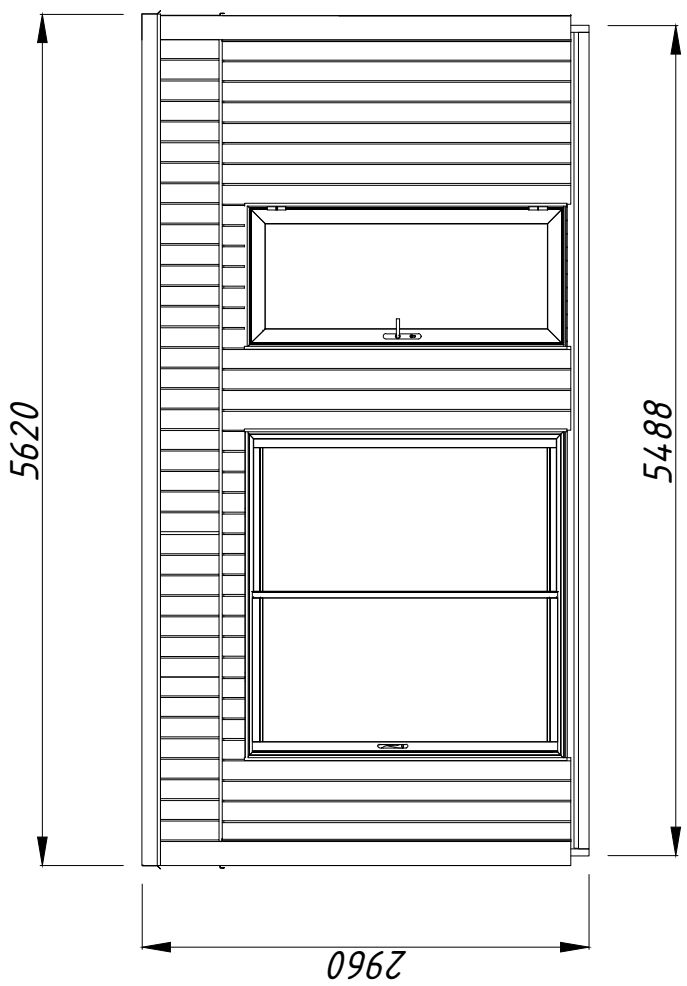
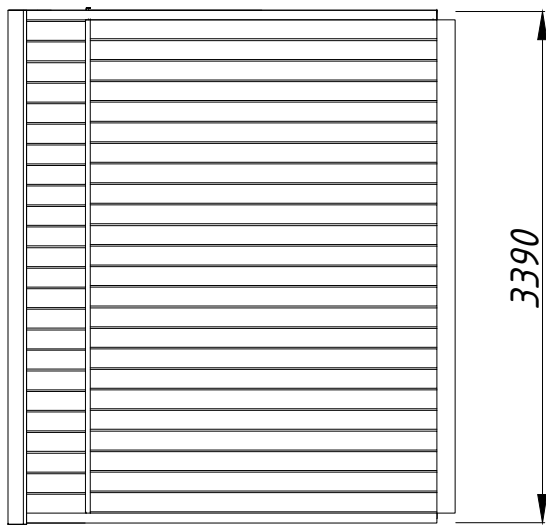
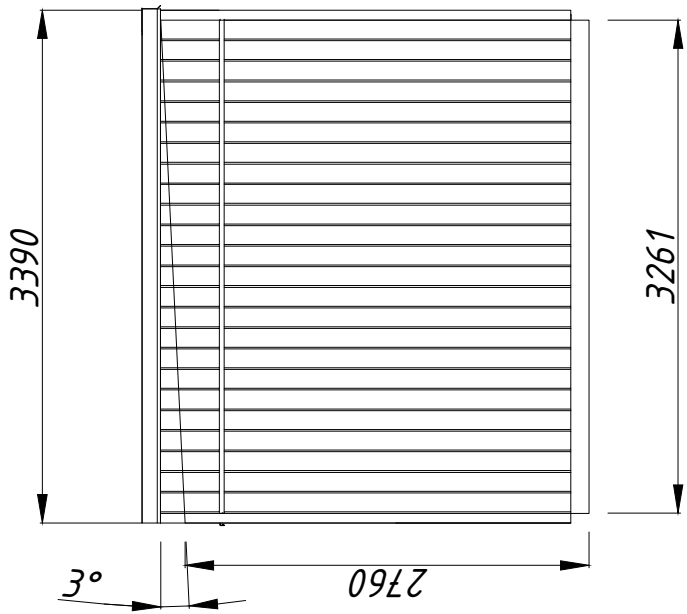

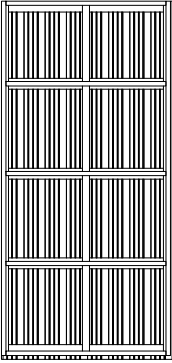
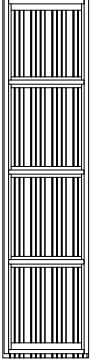
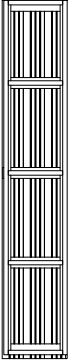

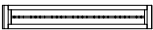

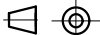







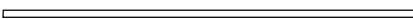

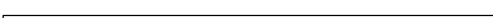



Latviešu (Mākslīgā intelekta tulkojums): Pirms produkta uzstādīšanas un lietošanas, lūdzu, izlasiet instrukcijas un garantijas noteikumus vietnē www.palmako.ee/information-hub, lai garantētu pareizu uzstādīšanu un ilgstošu darbību.

Lietuviškai (Išvertė DI): Prieš montuodami ir naudodami gaminį, perskaitykite instrukcijas ir garantijos sąlygas adresu www.palmako.ee/information-hub, kad užtikrintumėte tinkamą montavimą ir ilgalaikį veikimą.









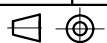

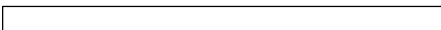

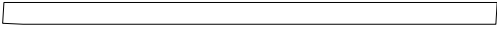
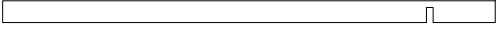

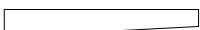



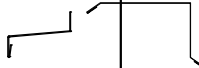
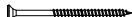

Pos	SPECIFICATION-STÜCKLISTE-NOMENCLATURE-ELEMENTI-ESPECIFICACIÓN EL18-5634-1-1	Pcs	Profile (mm)	Length (mm)
EL1		10	1087X160	2280
EL2		1	543X160	2280
EL3		2	407X160	2280
EL4		1	150X160	2175
EL5		1	150X160	950
EL-Door		1	137X160	2280
	Object name EL18-5634-1-1			Page 1/1

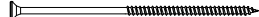
Pos	SPECIFICATION-STÜCKLISTE-NOMENCLATURE-ELEMENTI-ESPECIFICACIÓN EL18-5634-1-2	Pcs	Profile (mm)	Length (mm)
AR1	Foundation- Fundament- Fondation- Fondazione- Vigas de cimentación 	4	45x70	2699
AR2	Foundation- Fundament- Fondation- Fondazione- Vigas de cimentación 	16	45x145	2654
AR3	Foundation- Fundament- Fondation- Fondazione- Vigas de cimentación 	2	45x145	3261
AR4	Foundation- Fundament- Fondation- Fondazione- Vigas de cimentación 	12	45x70	406
AR5	Foundation- Fundament- Fondation- Fondazione- Vigas de cimentación 	2	45x145	2765
BM1	Beam- Balken- Poutre- Trave- Viga 	1	140x44	2708
BM2	Beam- Balken- Poutre- Trave- Viga 	1	140x44	3390
Sla1	Slat- Leiste- Baguette- Listello- Listón 	4	45x45	2649
Sla2	Slat- Leiste- Baguette- Listello- Listón 	2	95x44	2744
Sla3	Slat- Leiste- Baguette- Listello- Listón 	2	95x44	3166
FB2-1	Floor board- Fussbodenbrett- Madrier du plancher - Tavola pavimento- Tabla de suelo 	60	89x19	2634
TB2-1	Terrace board- Terrassenbrett- Madrier de terrasse- Tavola terrazzo- Tabla de terraza 	5	120x28	3783
TB2-2	Terrace board- Terrassenbrett- Madrier de terrasse- Tavola terrazzo- Tabla de terraza 	5	120x28	1615
TB1-1	Ceiling board- Dachbodenbrett- Madrier du Grenier- Tavola soffitta- Tabla de techo 	9	95x19	3174
TB1-2	Ceiling board- Dachbodenbrett- Madrier du Grenier- Tavola soffitta- Tabla de techo 	10	95x19	2302
TB1-3	Ceiling board- Dachbodenbrett- Madrier du Grenier- Tavola soffitta- Tabla de techo 	9	95x19	2124
UL1	Ukse laudis 	4	70x12	2250
UL2	Ukse laudis 	1	70x12	950
UL3	Ukse laudis 	1	70x12	2165
UL4	Ukse laudis 	1	19x95	2165
UL5	Ukse laudis 	1	19x95	945
WG6-1	Water gutter- Wasserleiste- Rejet d'eau- Protección de lluvia- Protezione dalla pioggia- QP81x58x...HA 	2		2850
WG6-2	Water gutter- Wasserleiste- Rejet d'eau- Protección de lluvia- Protezione dalla pioggia- QP81x58x...HA 	4		1830

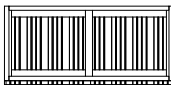

Pos	SPECIFICATION-STÜCKLISTE-NOMENCLATURE-ELEMENTI-ESPECIFICACIÓN EL18-5634-1-3	Pcs	Profile (mm)	Length (mm)
Pst1	Post- Pfosten- Poteau- Montante- Poste 	4	65x160	2829
RoR1	Rafter- Sparre- Chevron- Trave- Cabrio 	11	140x44	74
RoR2	Rafter- Sparre- Chevron- Trave- Cabrio 	11	140x44	143
RoR3	Rafter- Sparre- Chevron- Trave- Cabrio 	11	140x44	3181
RoR4	Rafter- Sparre- Chevron- Trave- Cabrio 	11	140x44	3170
Sla1	Slat- Leiste- Baguette- Listello- Listón 	4	95x44	2649
OSB_1	OSB_15mm 	2	1250x15	109
OSB_2	OSB_15mm 	2	1250x15	175
RB2-1	Roof board- Dachbrett- Madrier du toit- Tavola tetto- Tabla de tejado 	38	89x19	5298
QNA2 2x50Zn	Nail- Nagel- Clou- Chiodo- Clavo- 2.5x50mm 	400	FB2-1	
QNA3 x70Zn	Nail- Nagel- Clou- Chiodo- Clavo- 3x70mm 	500	RB2-1	
QKRPP4 5x60Zn	Screw- Schraube- Vis- Vite- Tornillo- 4.5x60mm 	600	EL1, 2, 3 TB1-1, 2, 3 OSB 1, 2, 3	Sla1
QKRK K4_8 x28MU	Screw- Schraube- Vis- Vite- Tornillo- 4.8x28mm MU 	60		
QKRPP5 x80ZnTX	Screw- Schraube- Vis- Vite- Tornillo- 5x80mm 	300	AR1, 2, 3... EL1, 2, 3 + AR1, 2... EL1, 2, 3 + Sla 2, 3 EL9, 10, 11 BM1,2+Sla4 TB2-1,2	Pst1
QKRP P6x1 20ZnTX	Screw- Schraube- Vis- Vite- Tornillo- 6x120mm TX 	22	RoR1, 2, 3, 4 BM1,2+EL1, EL2	
QKRPP 6x160 ZnTX-1	Screw- Schraube- Vis- Vite- Tornillo- 6x160mm TX-1 	130	AR1, 2, 3... RoR1, 2, 3, 4	
QKRPP 8x240 kZnTX	Screw- Schraube- Vis- Vite- Tornillo- 8x240mm 	70	RoR1, 2, 3, 4	
EL9		10	1087X480	
EL10		1	543X480	
EL11		1	407X480	



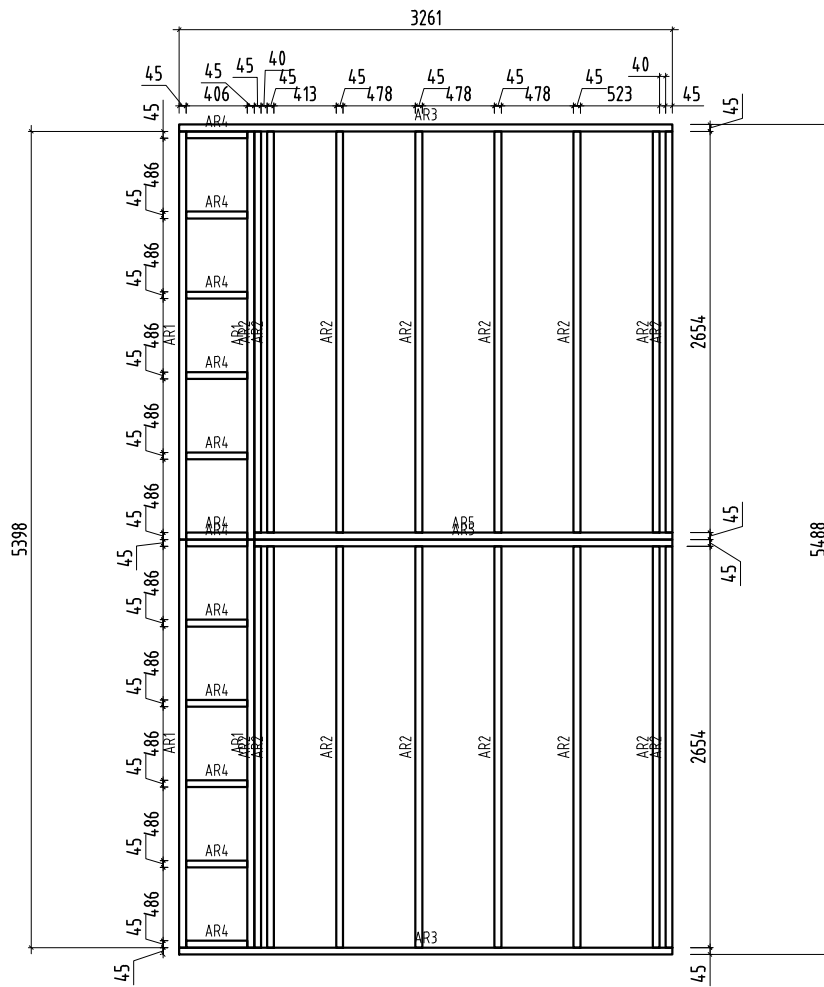

Foundation plan

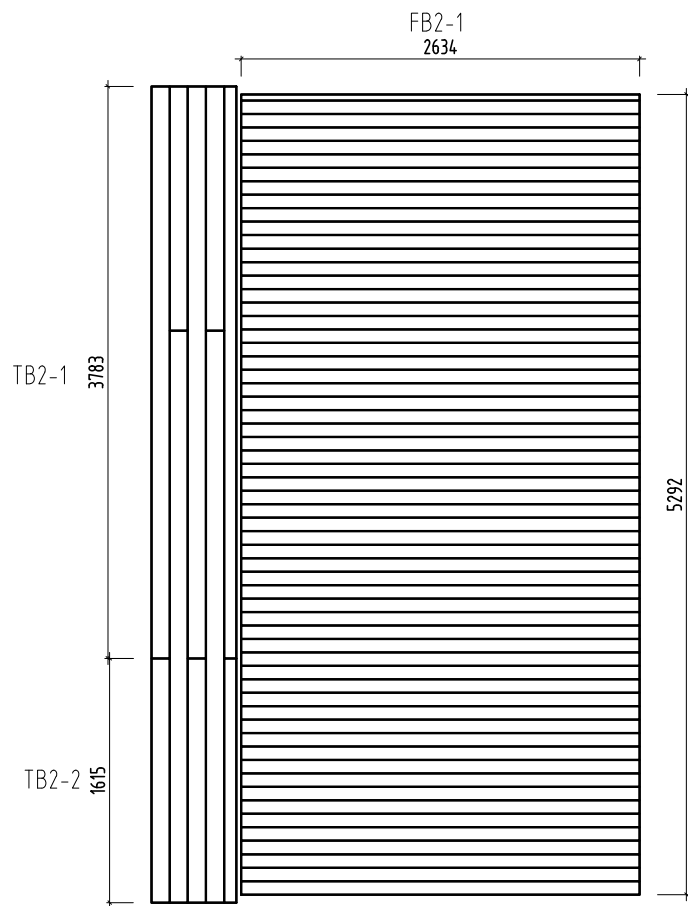

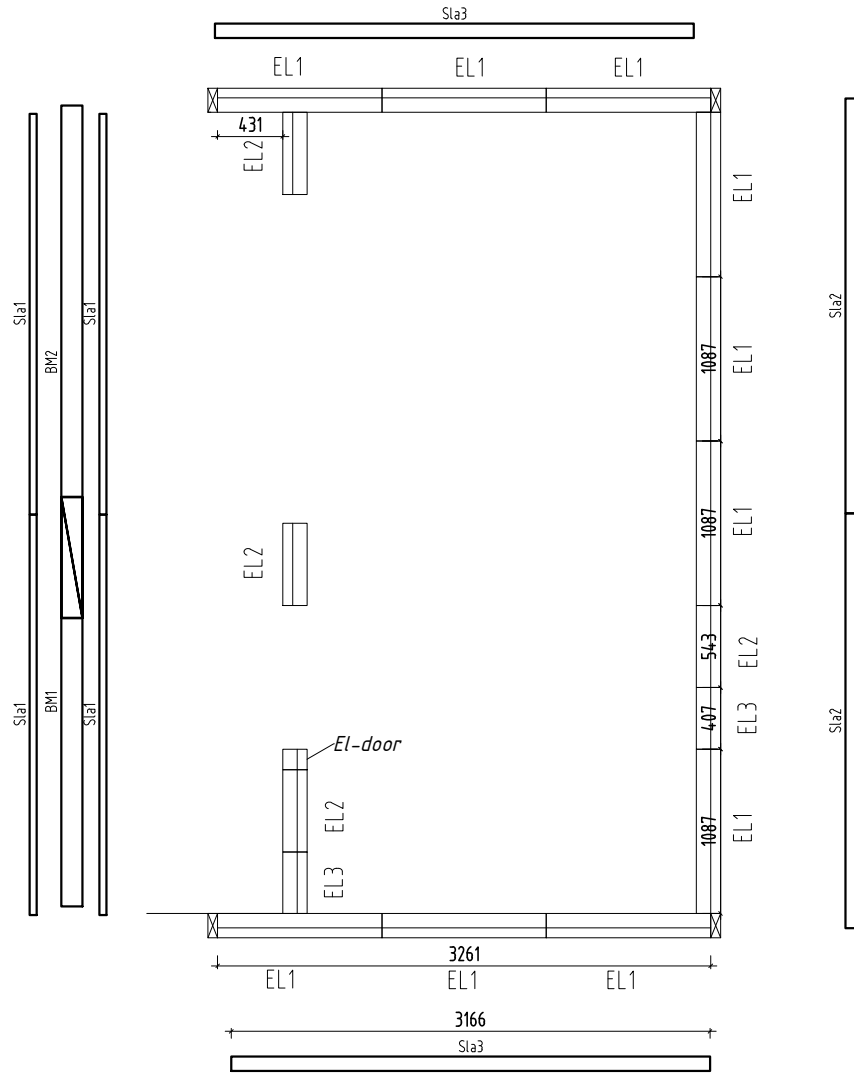

Wall panels position - Beams - Lath

NB!

1.

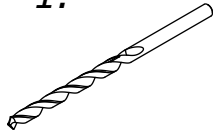

2.

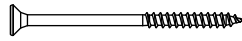

$\varnothing 1,5 \text{ mm}$	$\varnothing 3,0...4$
$\varnothing 2,0 \text{ mm}$	$\varnothing 4,5$
$\varnothing 3,0 \text{ mm}$	$\varnothing 5,0$

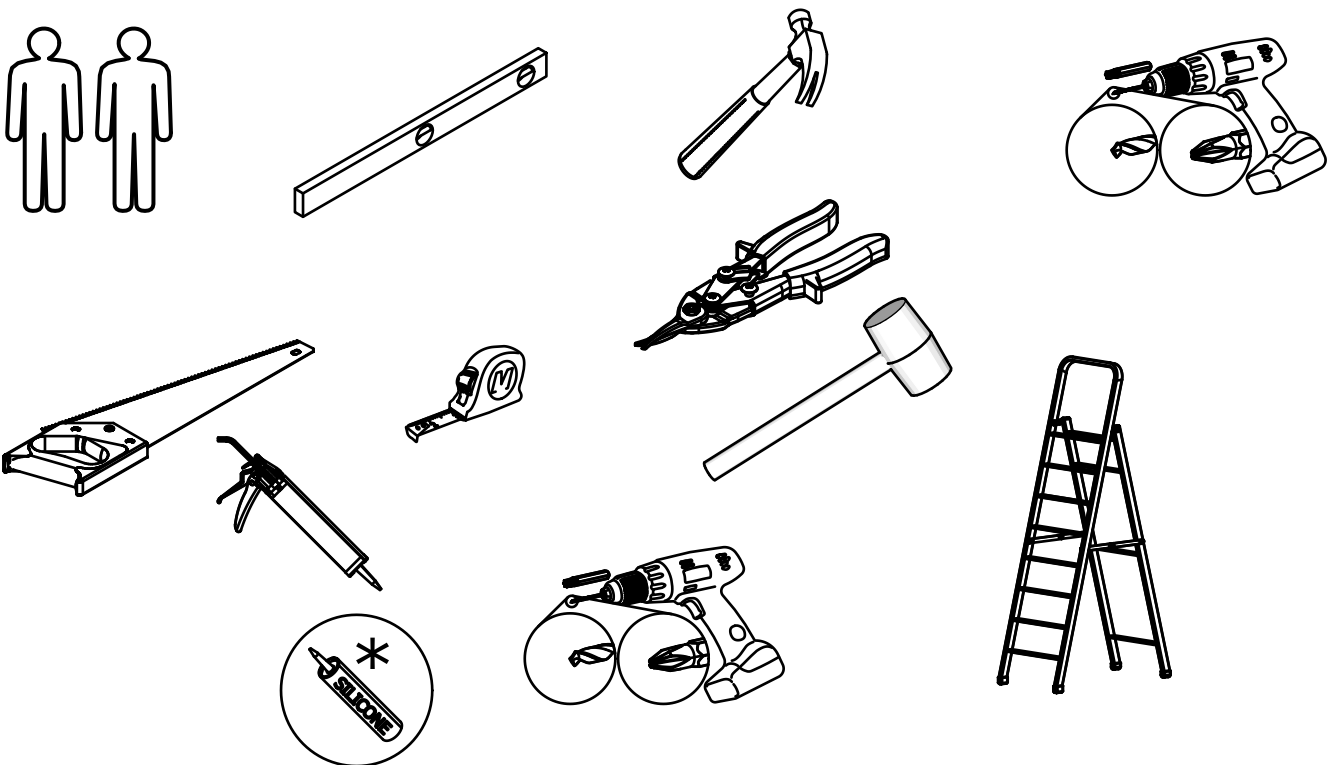
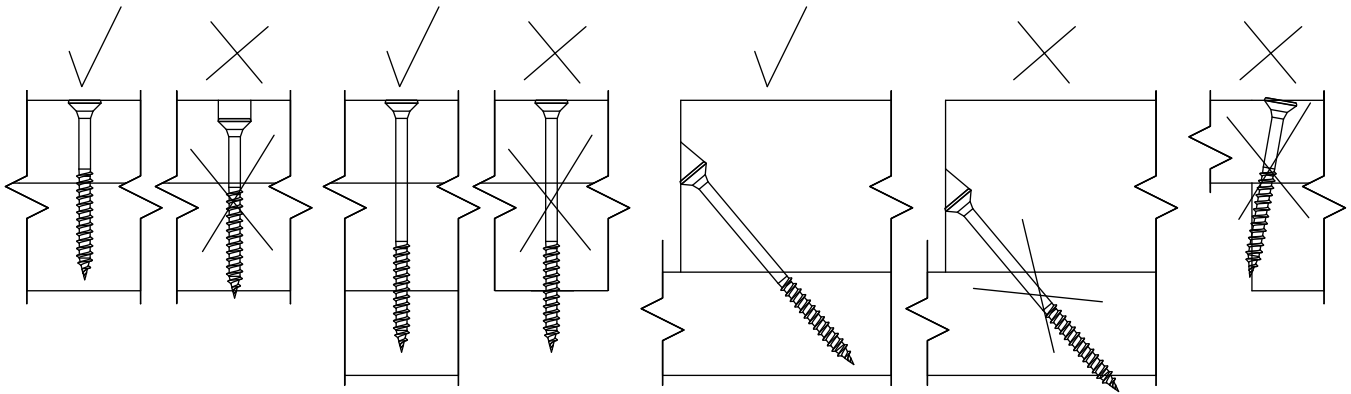

ENG	-	Not included
GER	-	Nicht enthalten
FR	-	Non inclus
ES	-	No incluso
IT	-	Non incluso
NO	-	Ikke inkludert
SWE	-	Ingår inte
FIN	-	Ei sisälly hintaan
DEN	-	Ikke inkluderet
NED	-	Niet inbegrepen
POR	-	Não incluído
CZ	-	Není zahrnuto
POL	-	Nie wliczone
LIT	-	Neįtraukta
LAT	-	Nav iekļauts
RUS	-	Не включено
EST	-	Ei sisaldu komplektis

ENG	-	Separate manual
GER	-	Separates Handbuch
FR	-	Manuel séparé
ES	-	Manual separado
IT	-	Manuale separato
NO	-	Separat manual
SWE	-	Separat manual
FIN	-	Erillinen käyttöohje
DEN	-	Separat manual
NED	-	Aparte handleiding
POR	-	Manual separado
CZ	-	Samostatný manuál
POL	-	Osobna instrukcja
LIT	-	Atskiras vadovas
LAT	-	Atsevišķa rokasgrāmata
RUS	-	Отдельное руководство
EST	-	Eraldi juhend

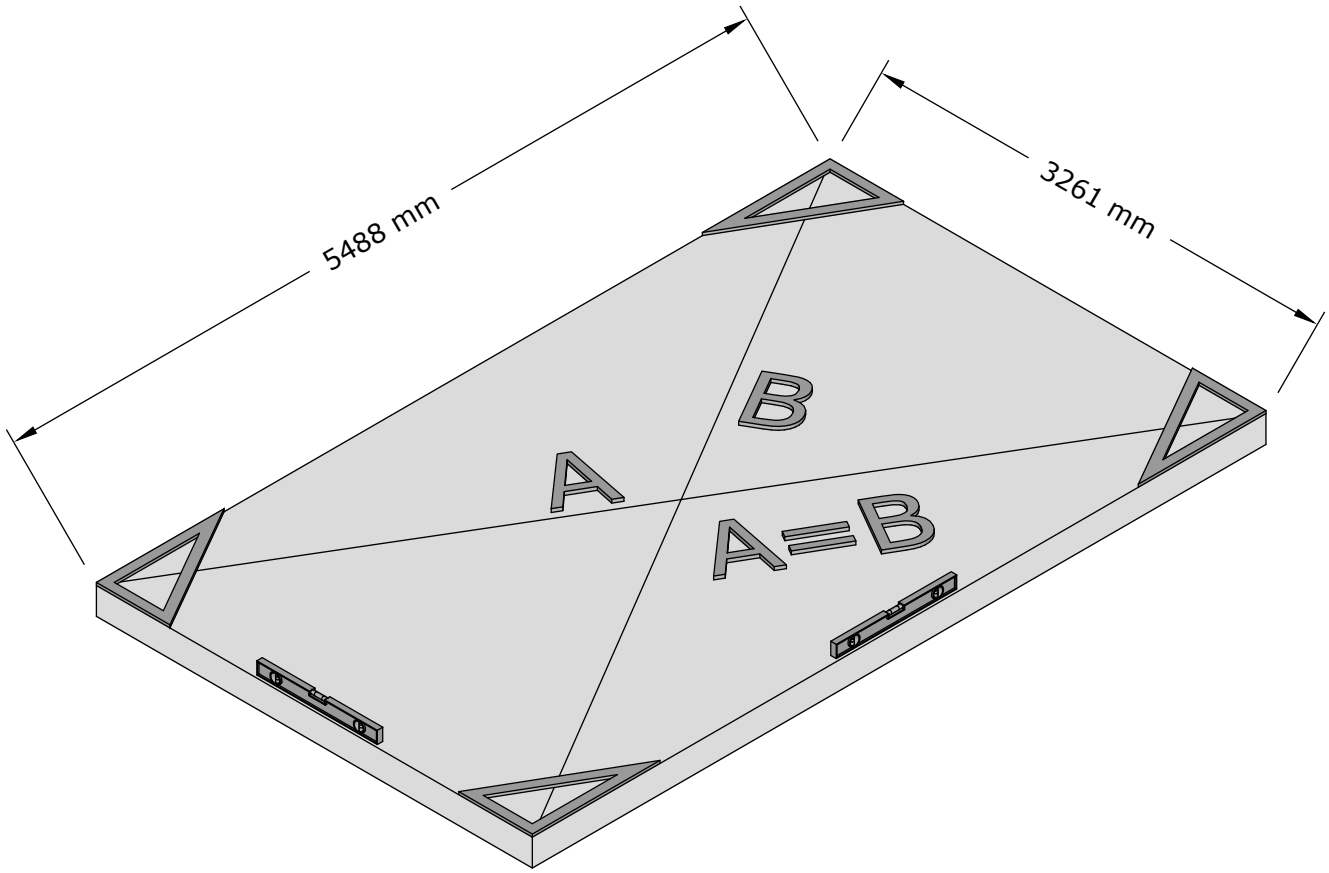
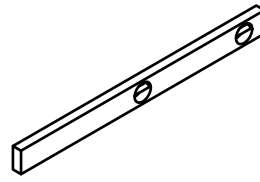

*

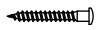
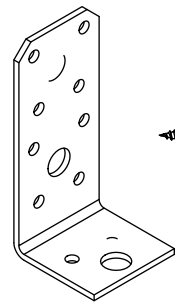
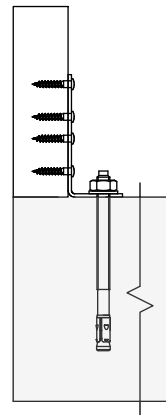

- AR1 x4
- AR2 x16
- AR3 x2
- AR4 x12
- AR5 x2

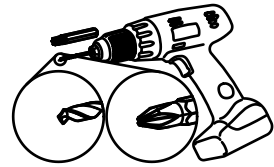
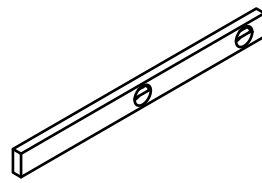

Ø5x80 x60

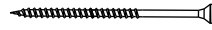

Ø6x160 x96

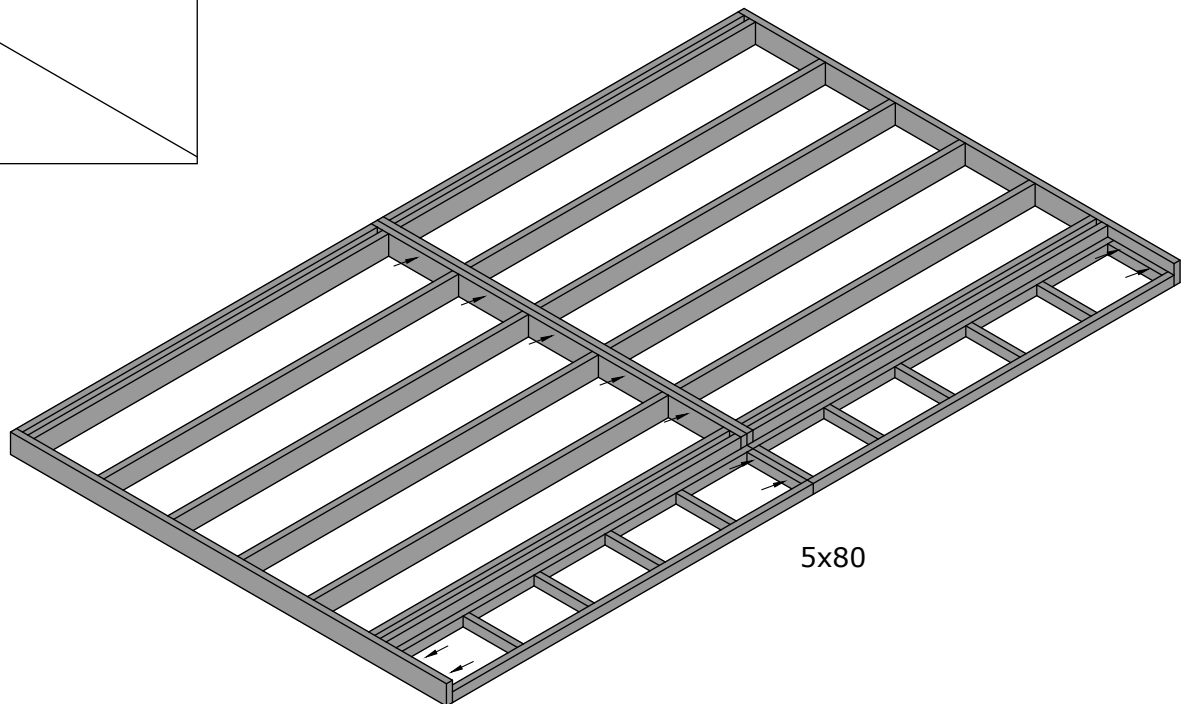
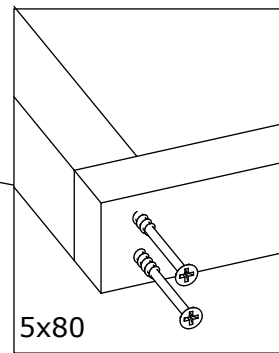
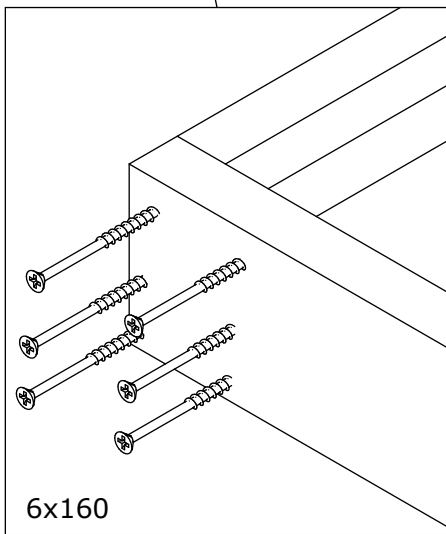
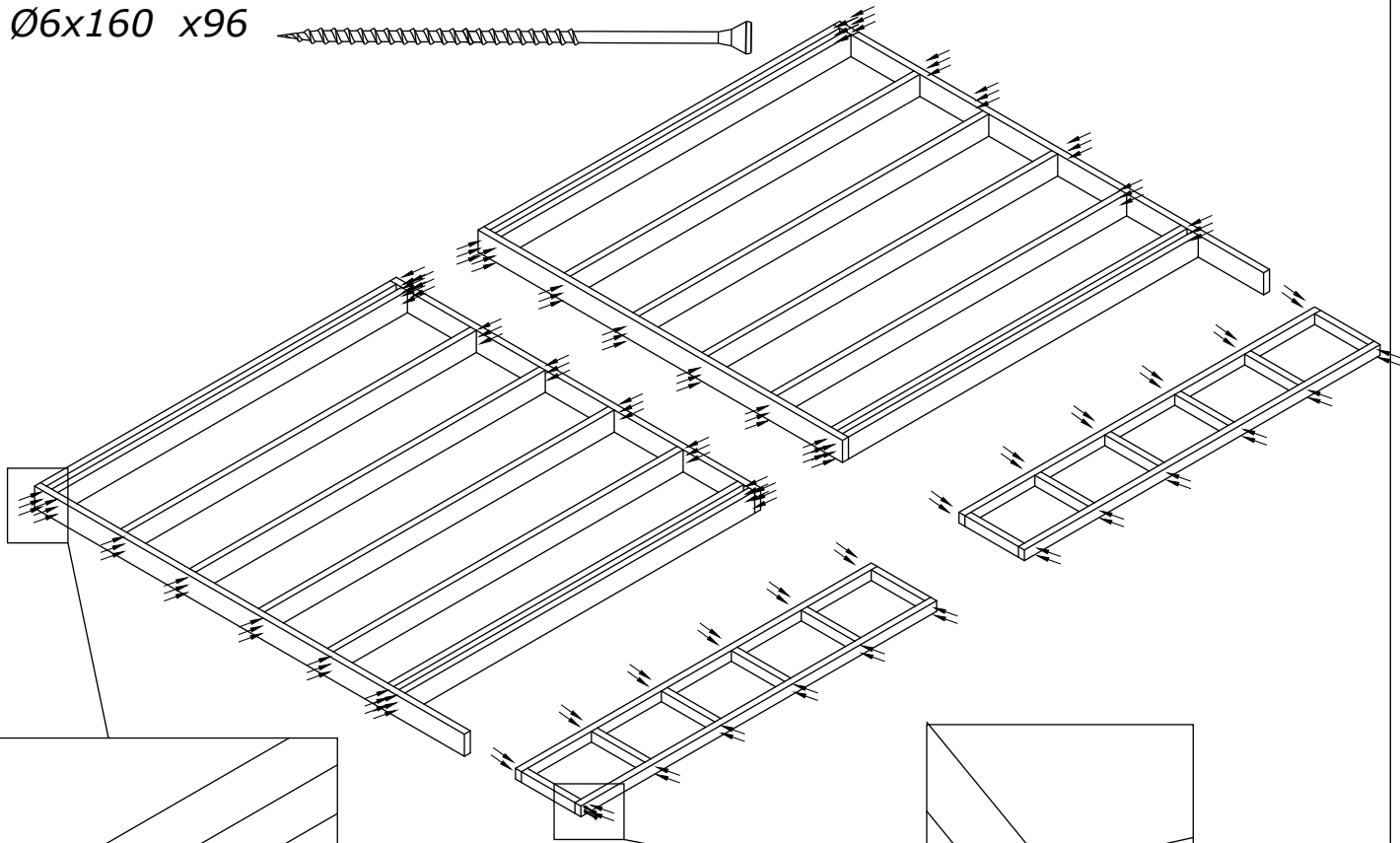
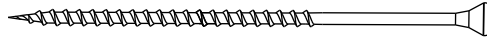

- E1 x11
- E2 x3
- E3 x1
- E4 x1
- E5 x1

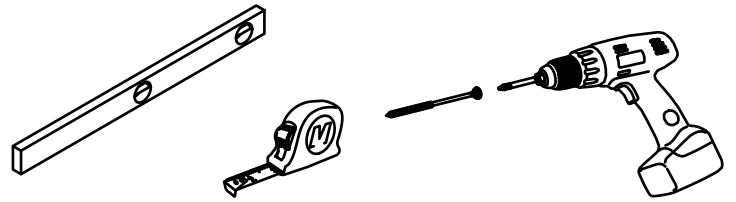

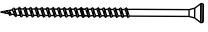
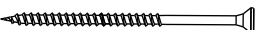
- Ø4,5x60 x68 
- Ø5x80 x51 

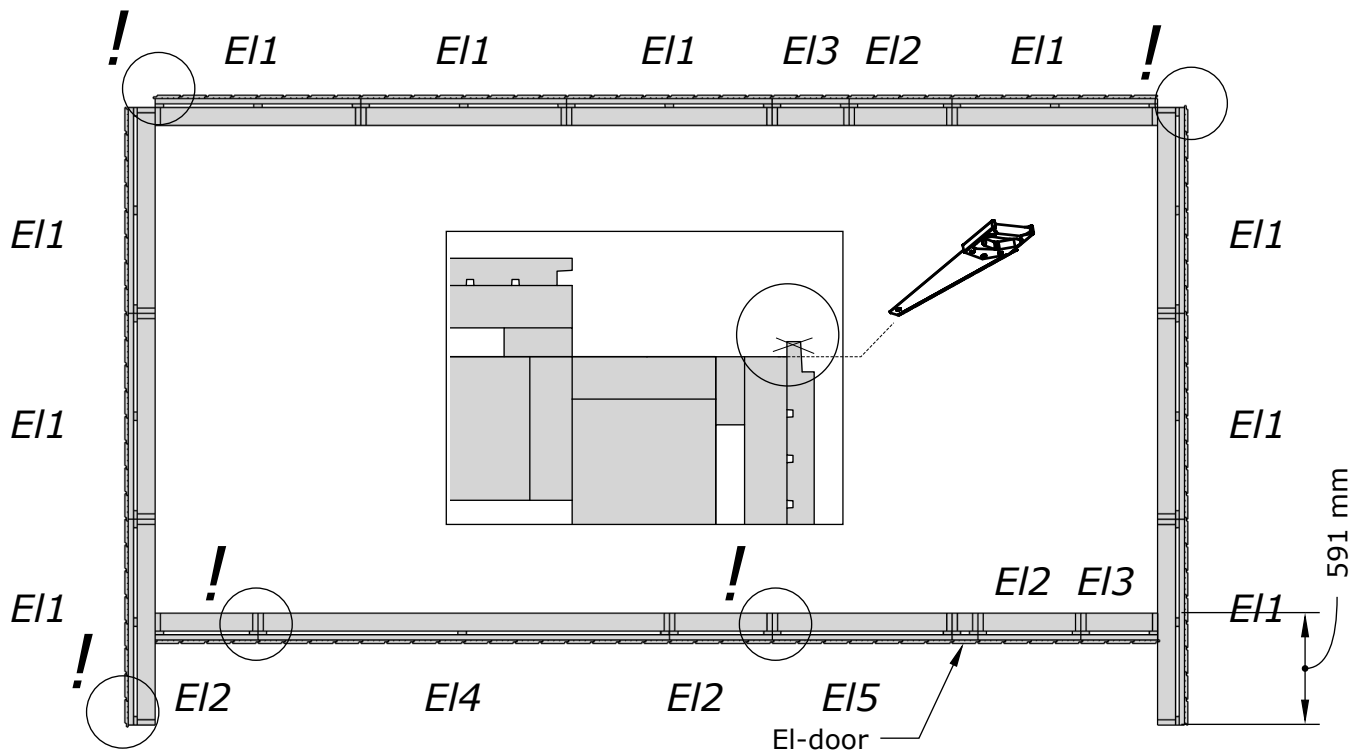
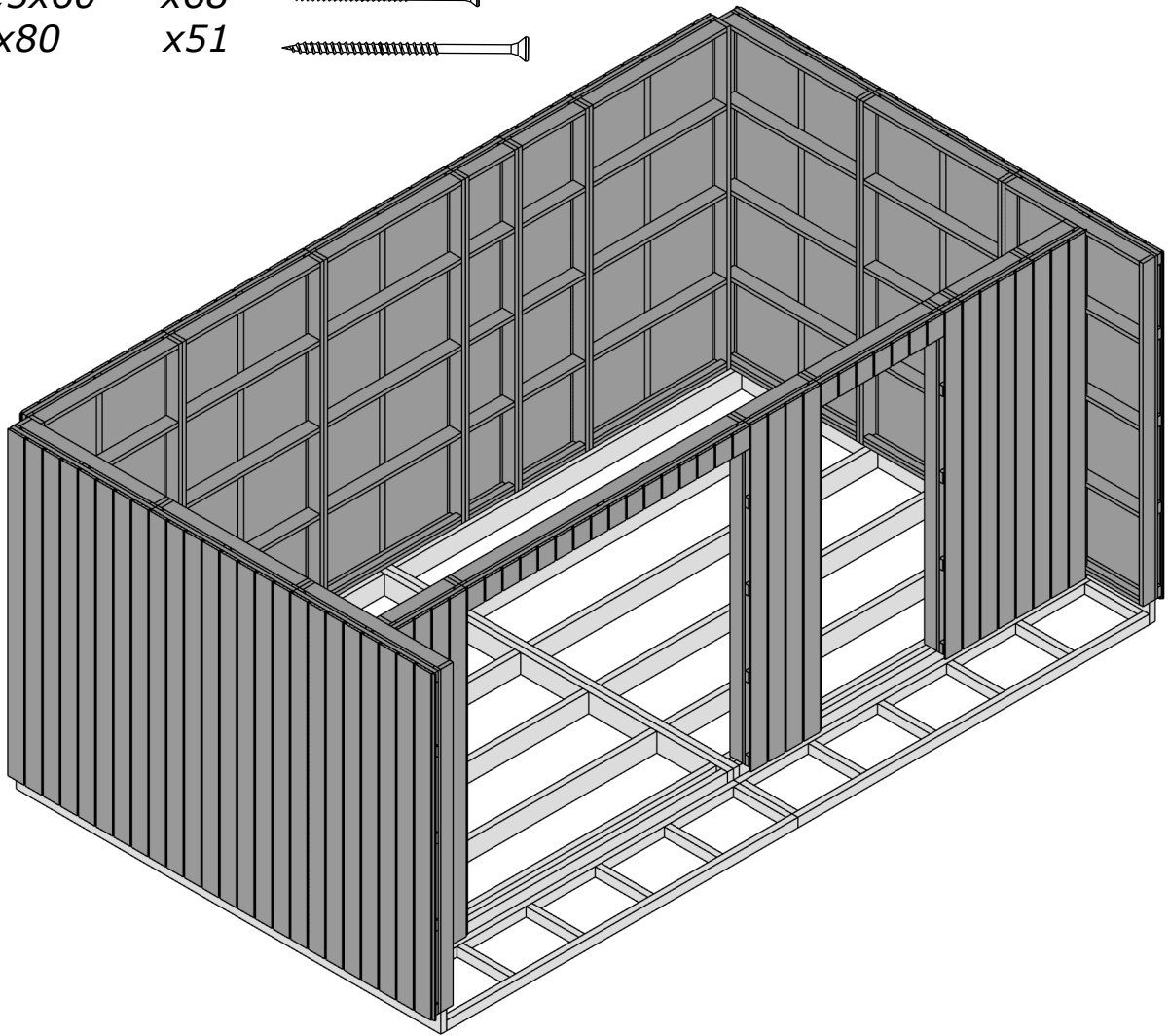

- E11 x11
- E12 x3
- E13 x1
- E14 x1
- E15 x1

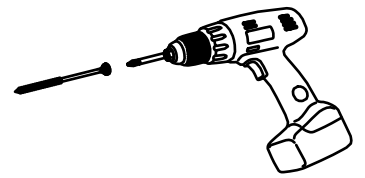
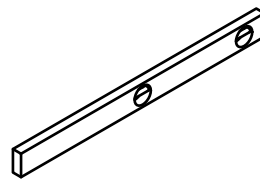

- Ø4,5x60 x68
- Ø5x80 x51

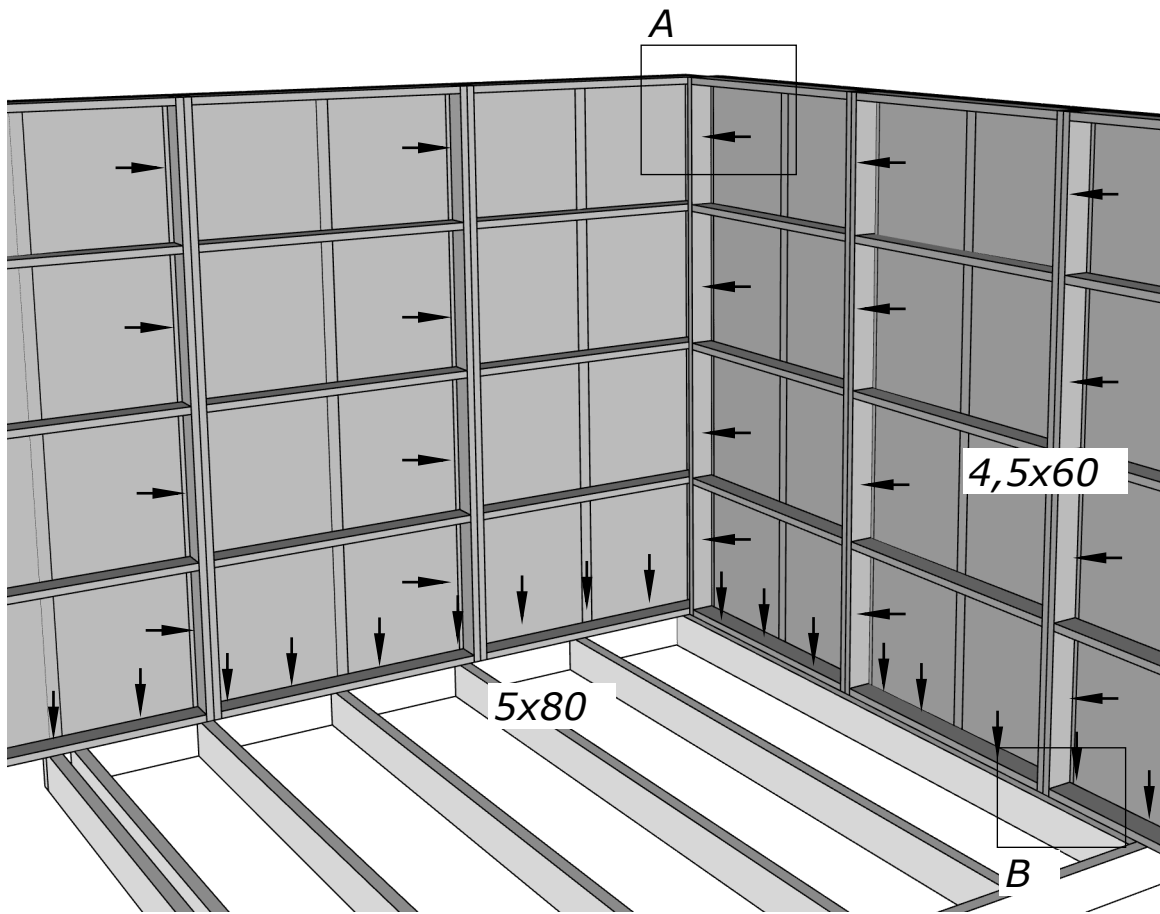
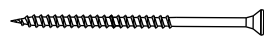
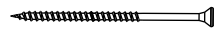

A

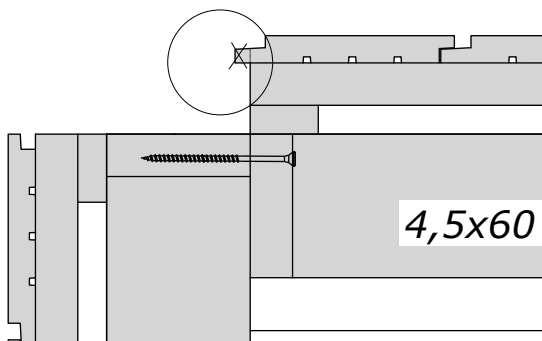

B

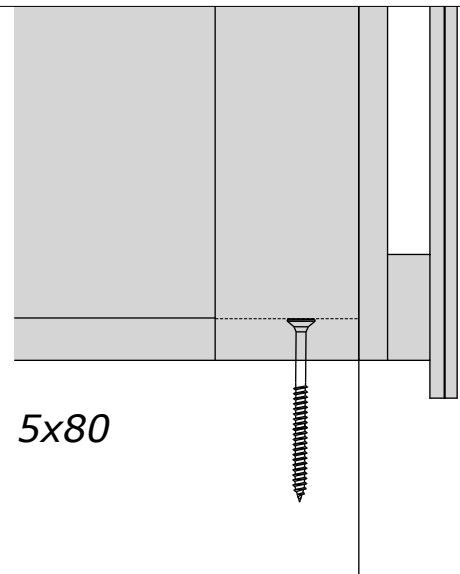

SlA2 x2
SlA3 x2

Ø5x80 x33

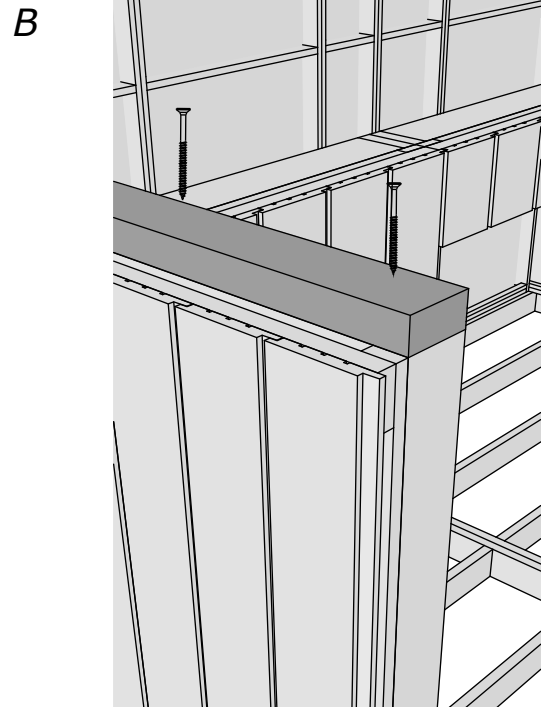
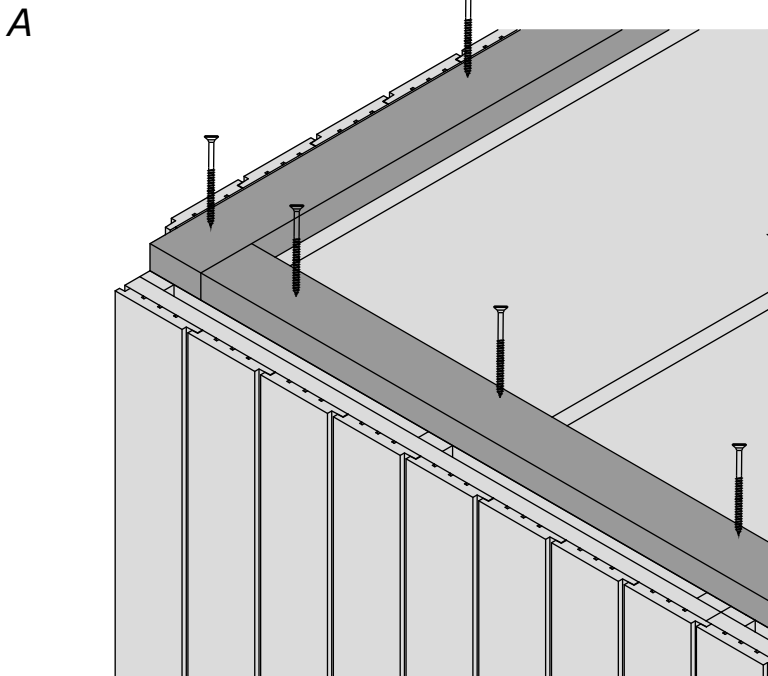
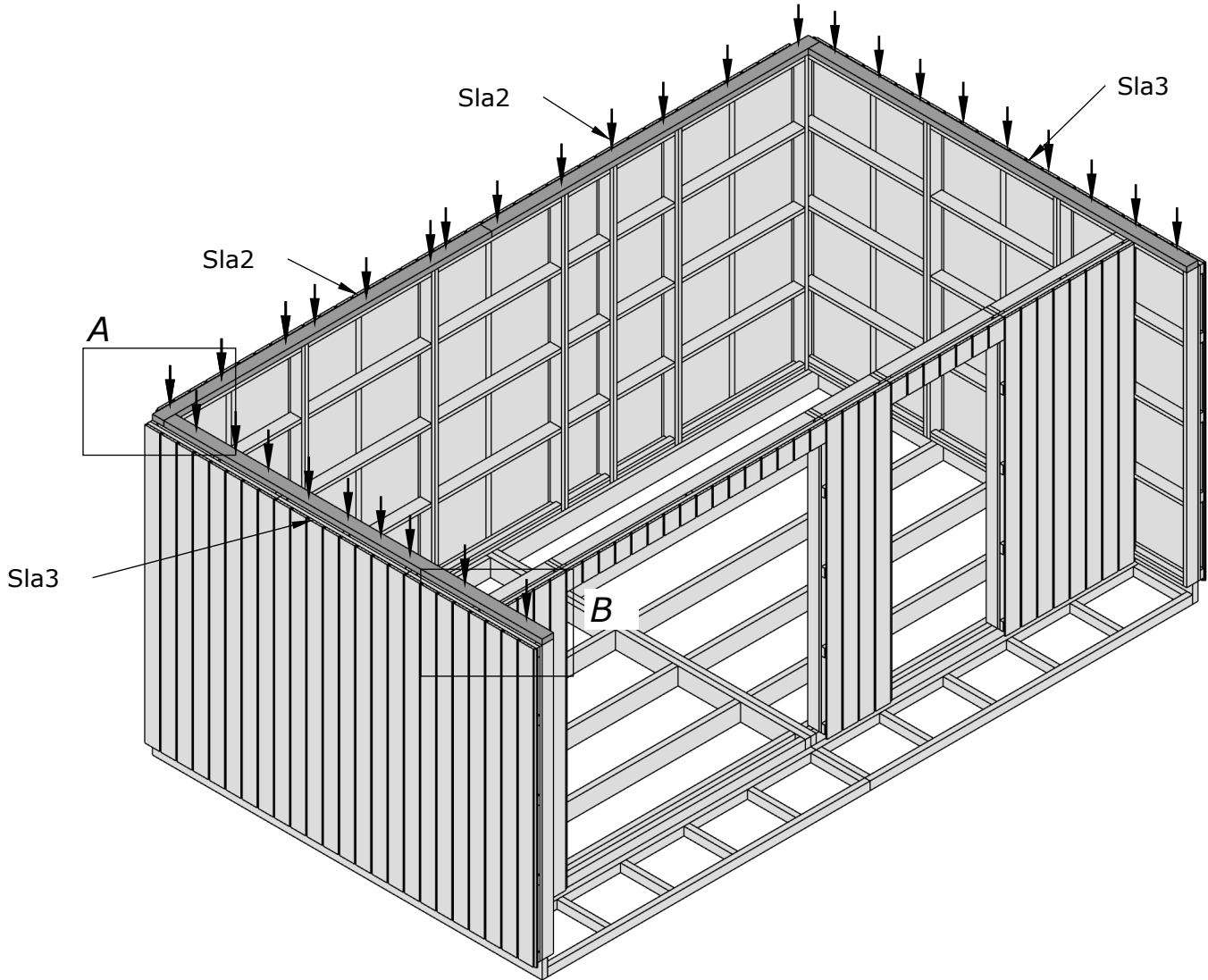
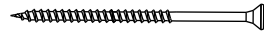
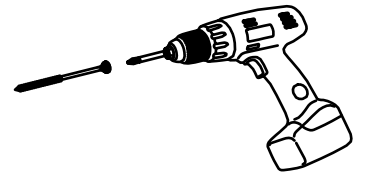
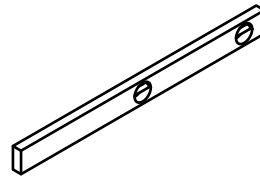

WG6-1 x2
WG6-2 x4



Ø4,8x28

x20

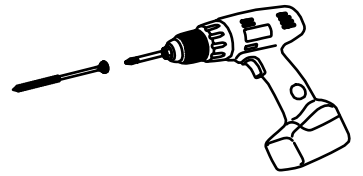
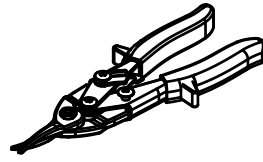

WG6-1

WG6-2

WG6-1

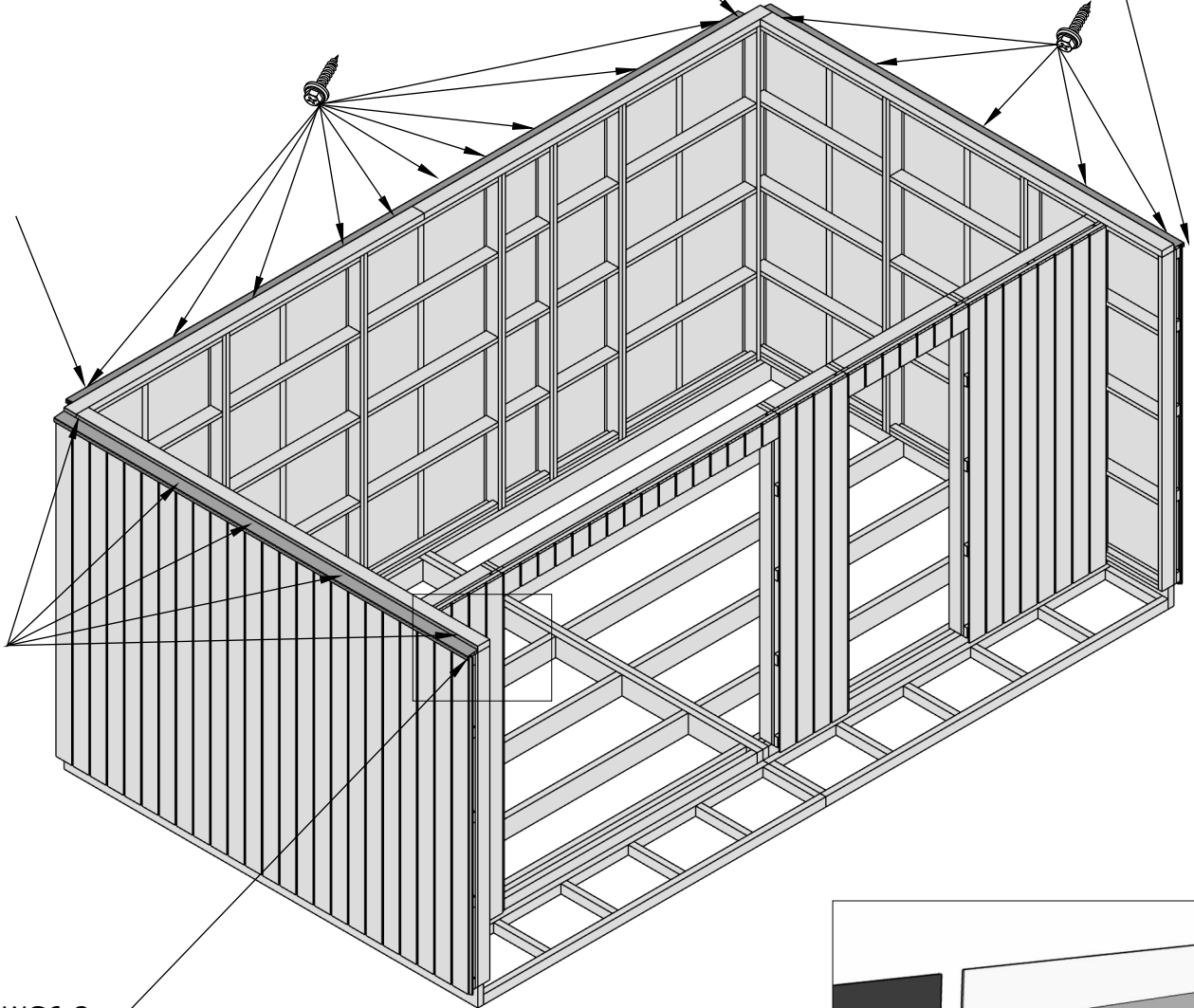

WG6-2

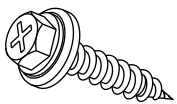
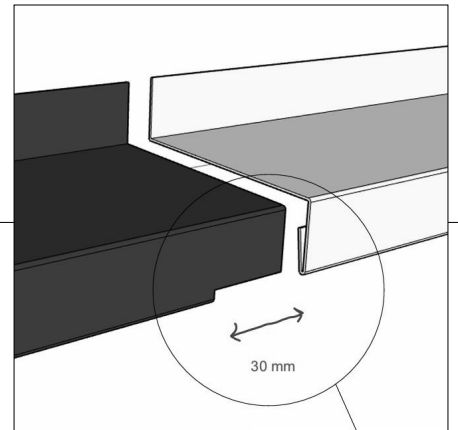

WG6

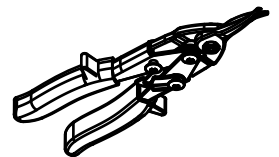
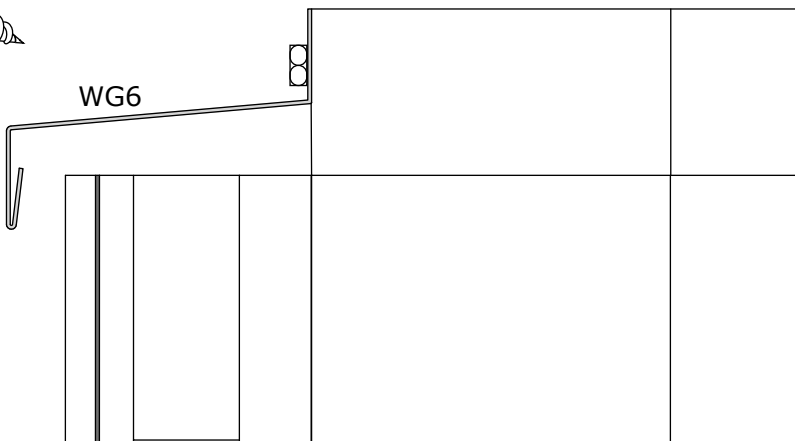

BM1 x1

BM2 x1

Ø6X120 x10 

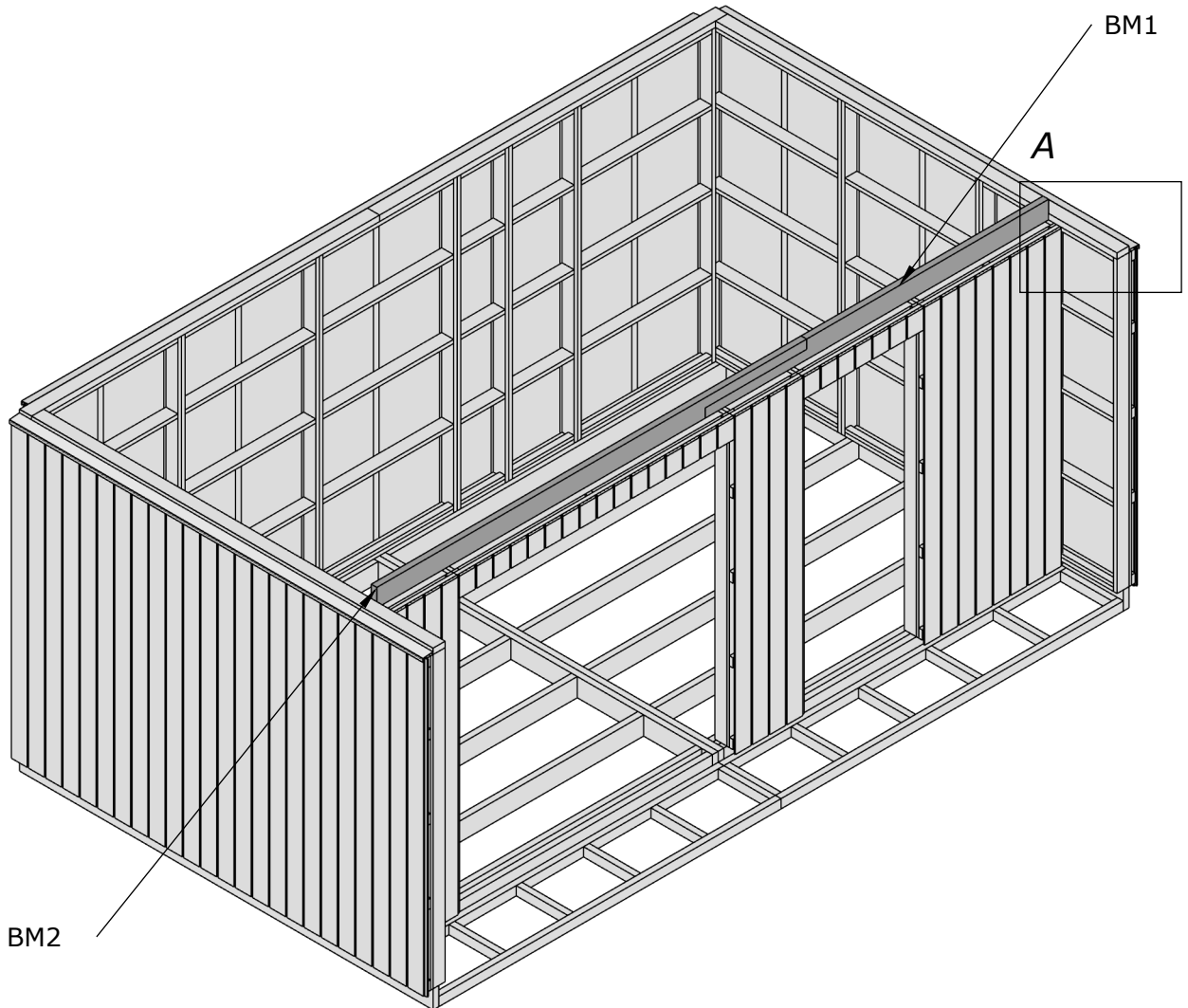
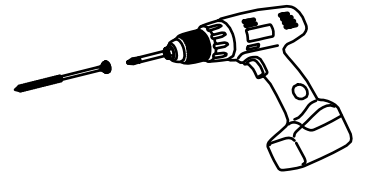

A

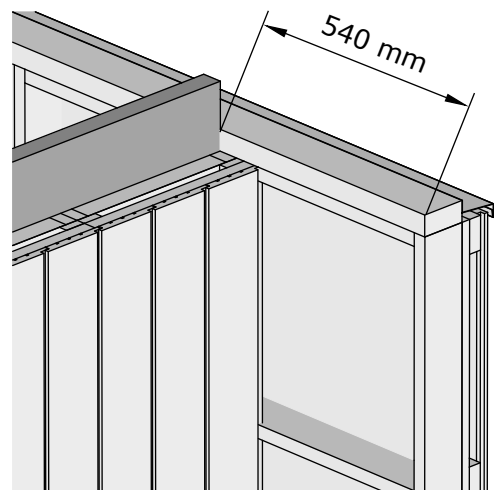
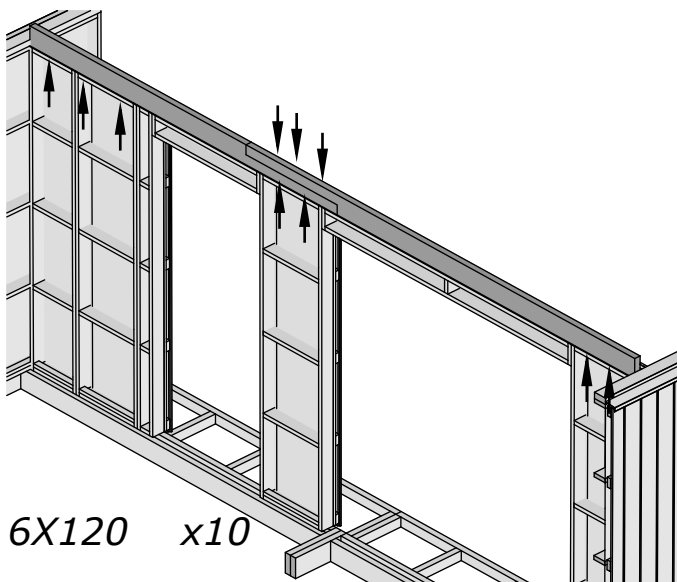

Sla1 x4

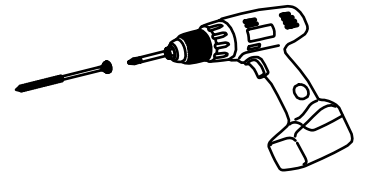

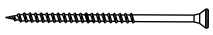
Ø4,5X60 x20 

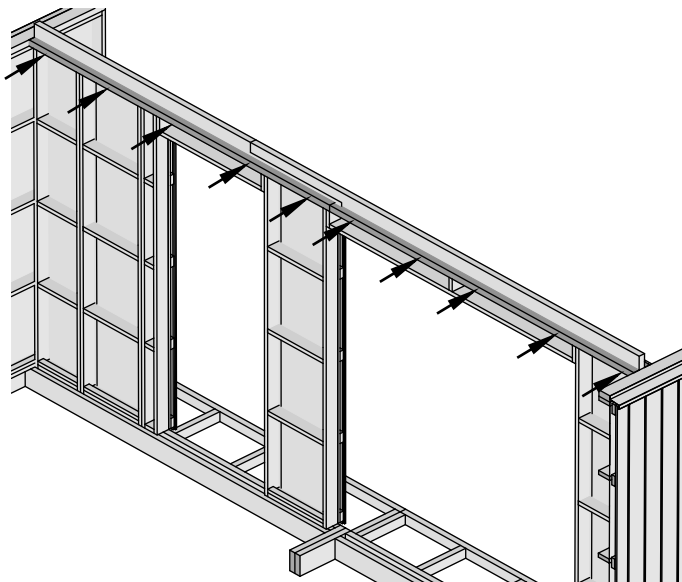
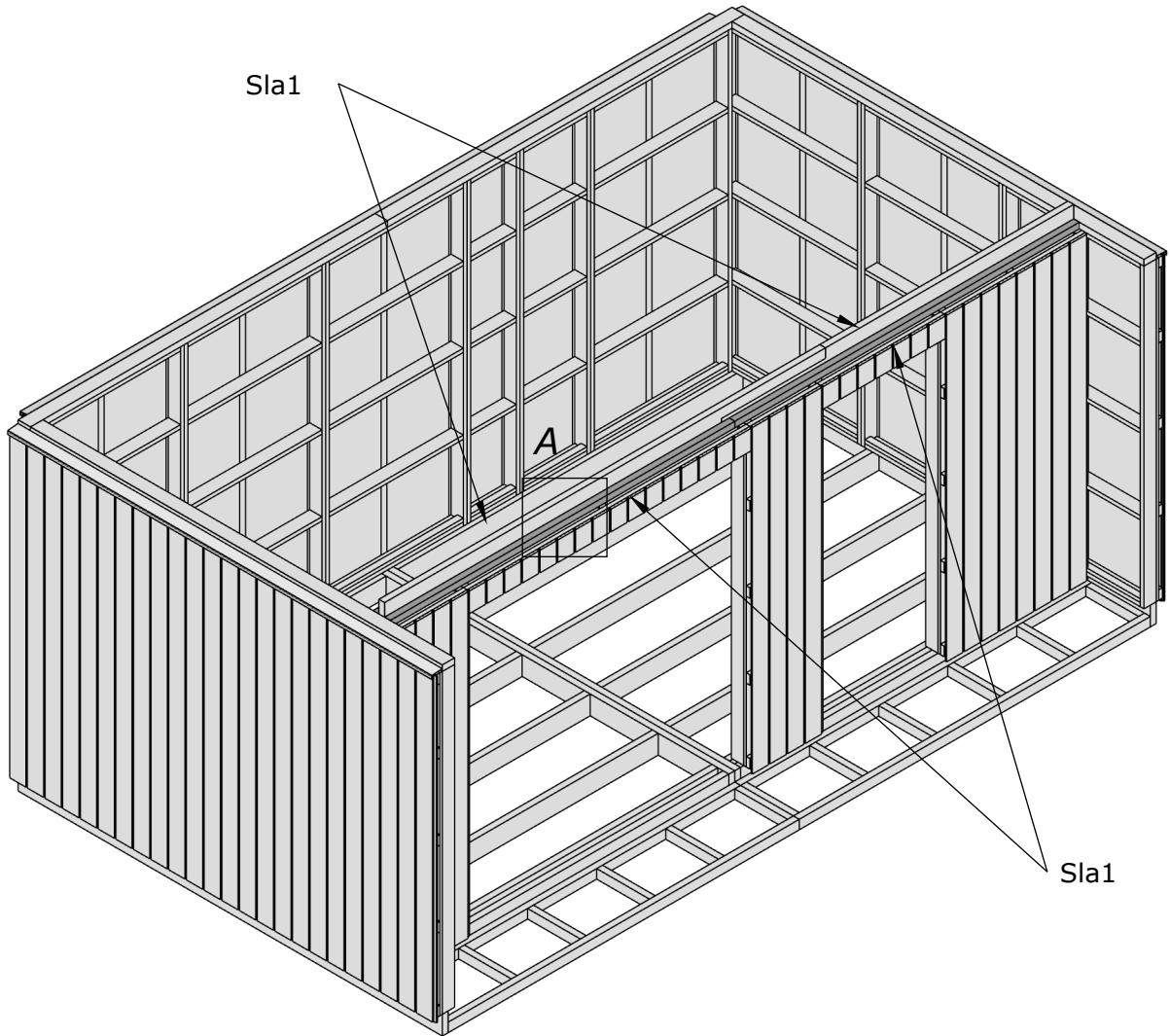

A

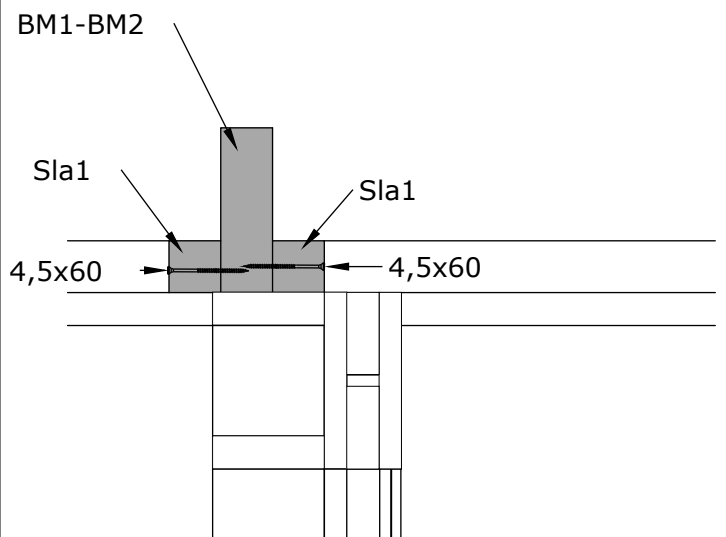

- ELEL1 x6
- ELEL2 x2
- ELEL3 x11
- ELEL4 x1
- ELEL5 x3

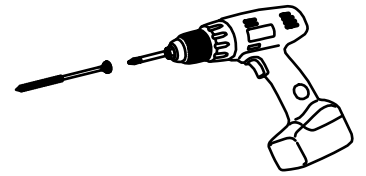

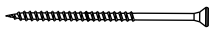
Ø4,5X60 x58 

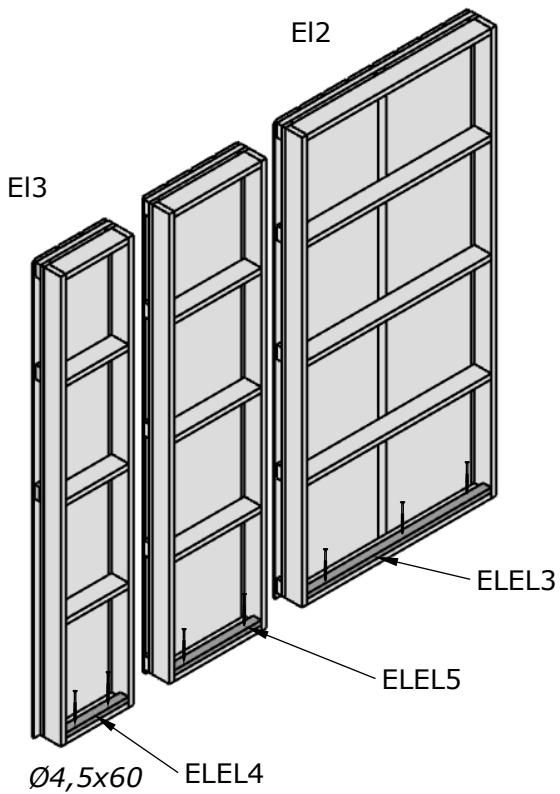
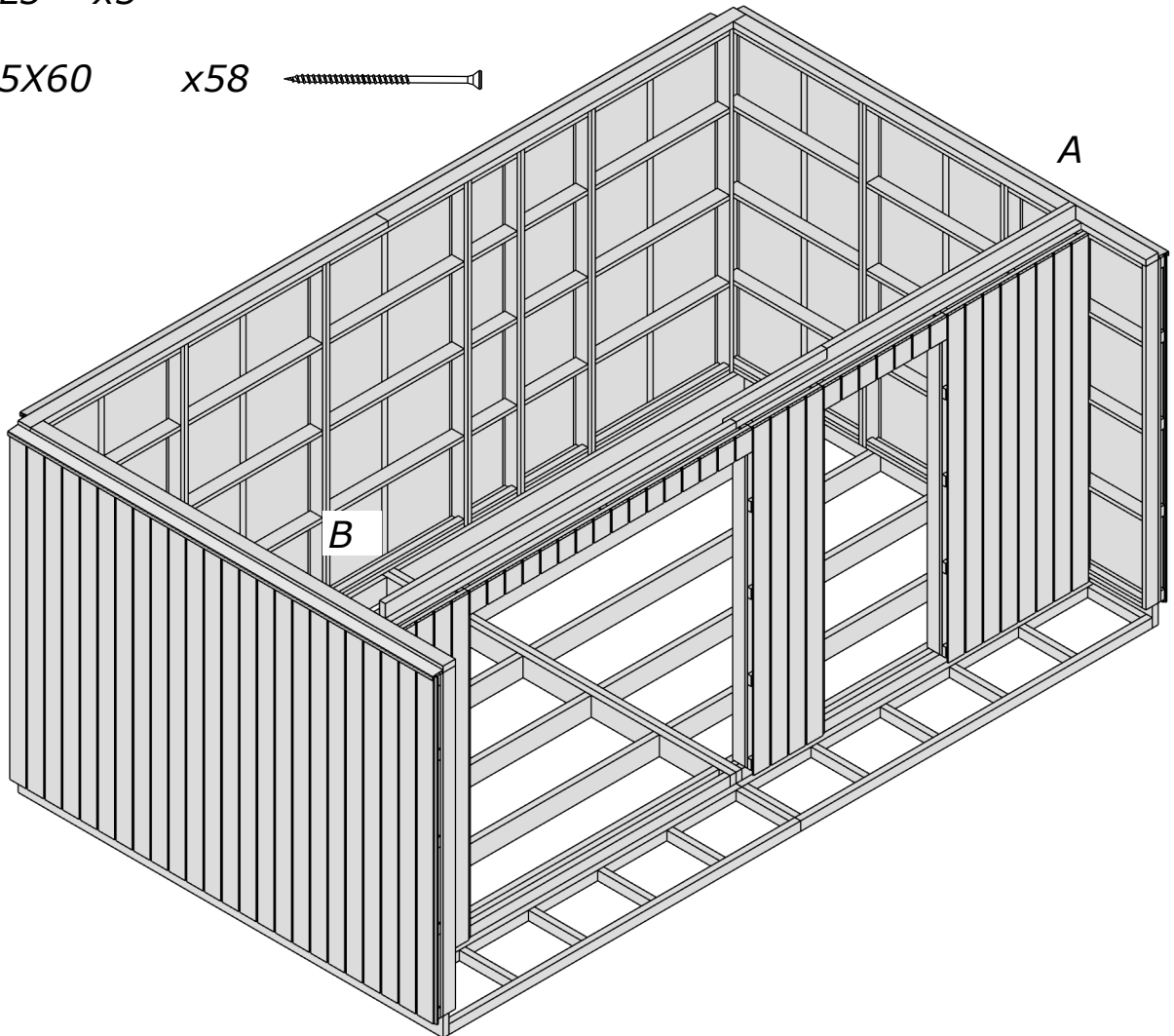

A - B

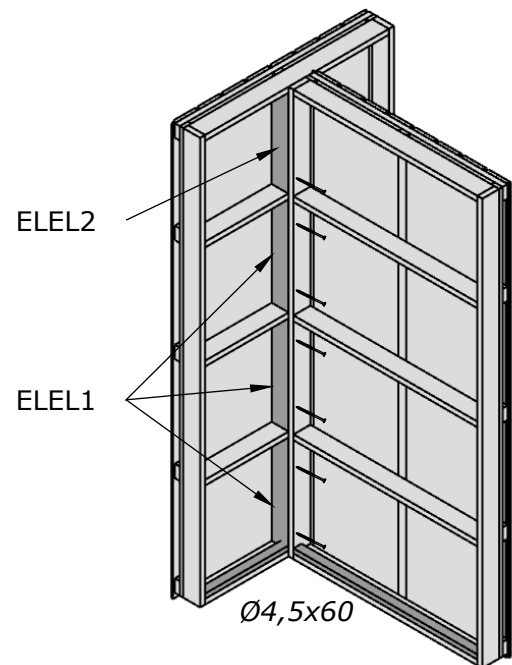

E19 x6

Ø4,5X60 x8
Ø5X80 x18

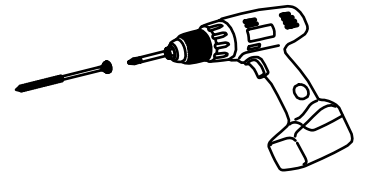
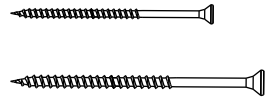

E19

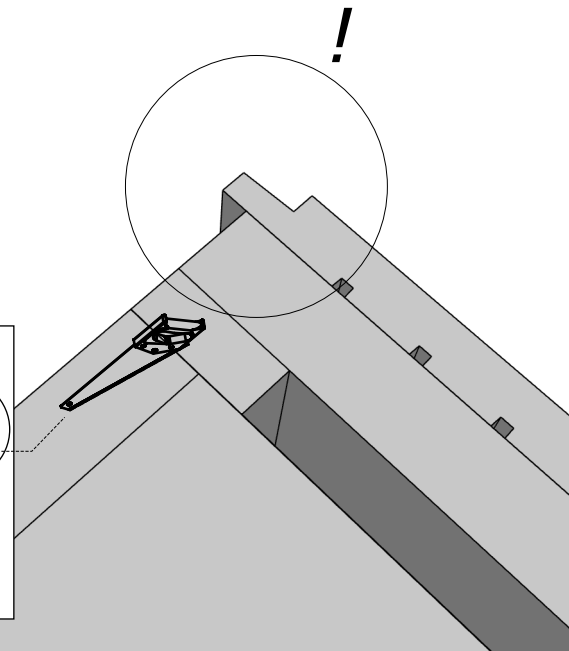
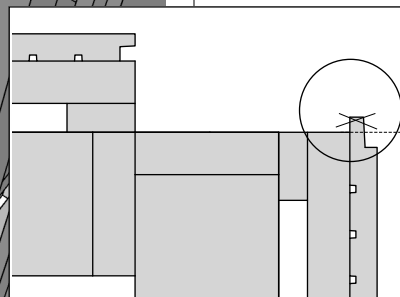
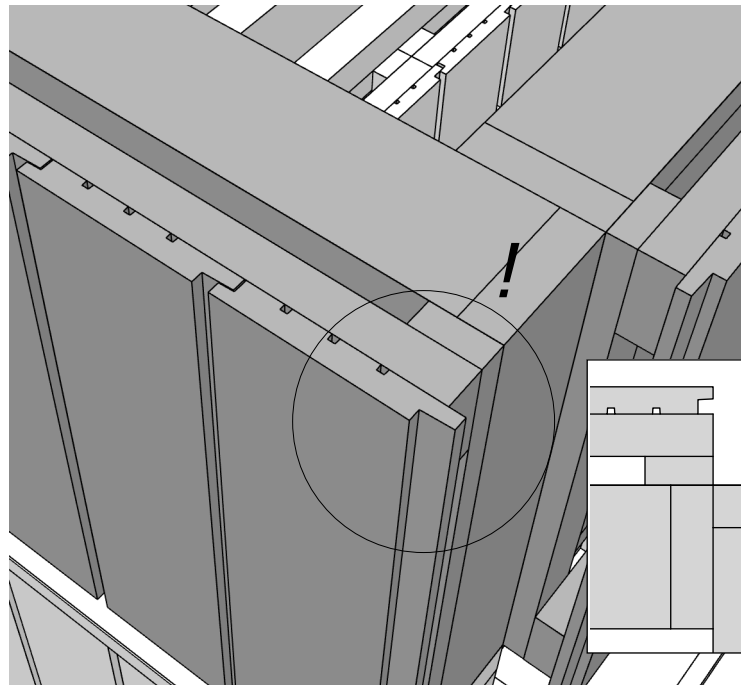
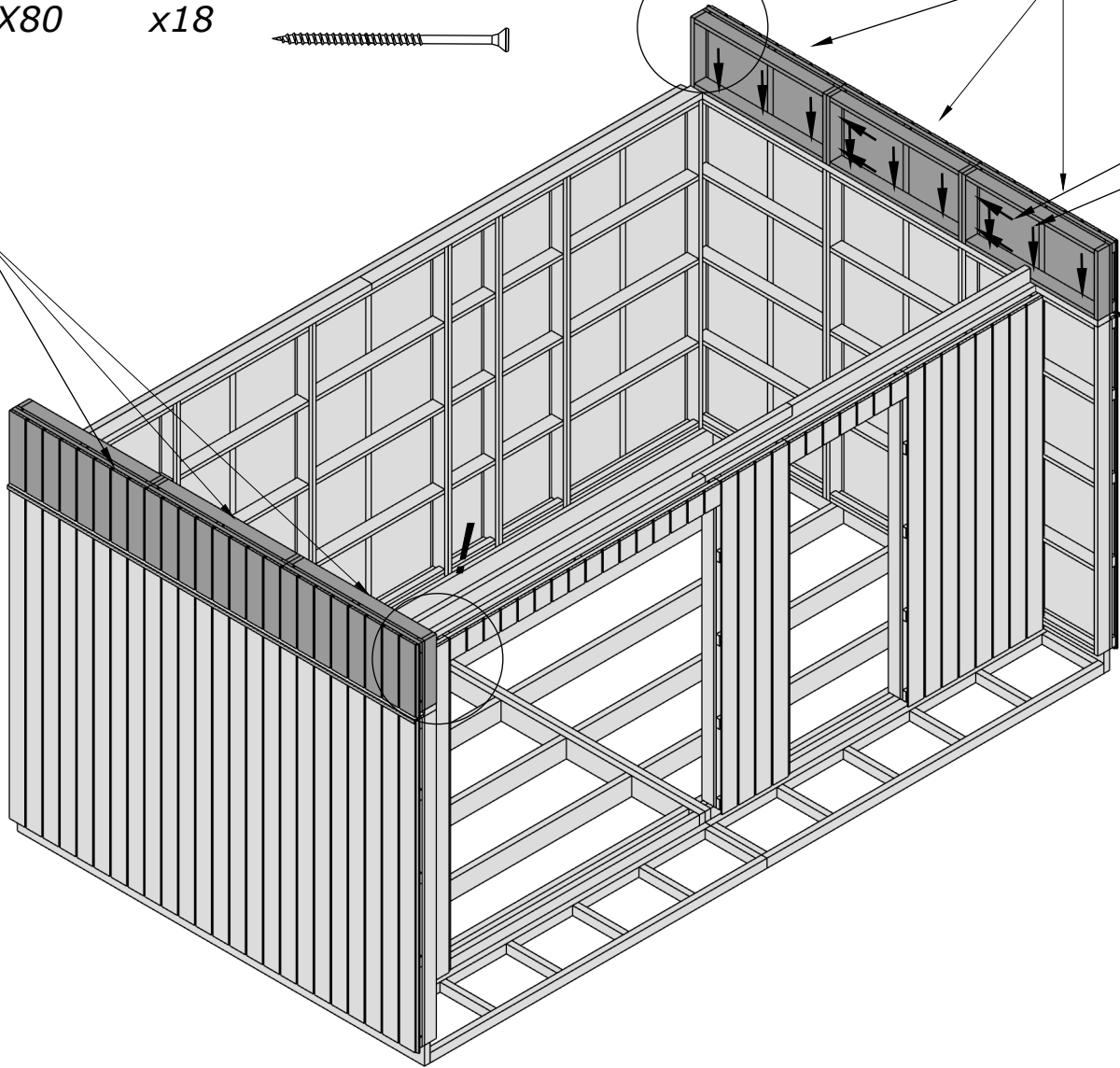

Ror1 x11
Ror2 x22
Ror3 x11
Ror4 x11

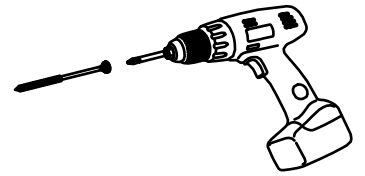

Ø8X240 x66 

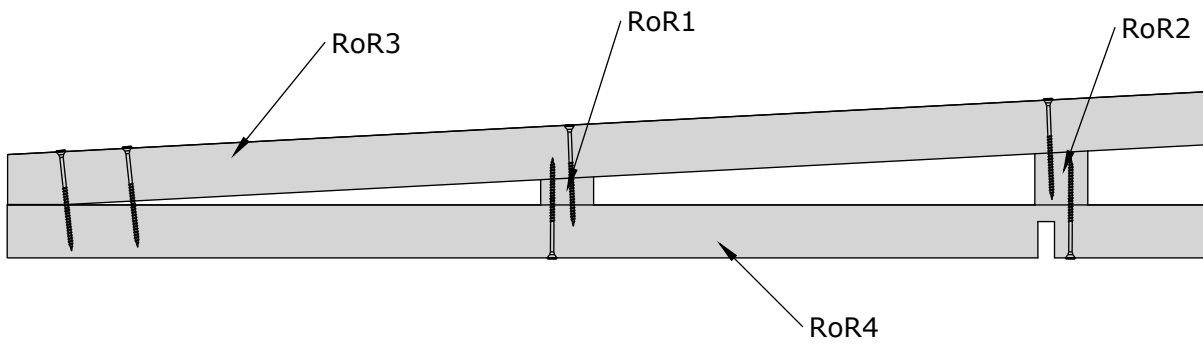

+ 525 + 525 + 525 + 525 + 525 + 525 + 525 + 525 + 525 +

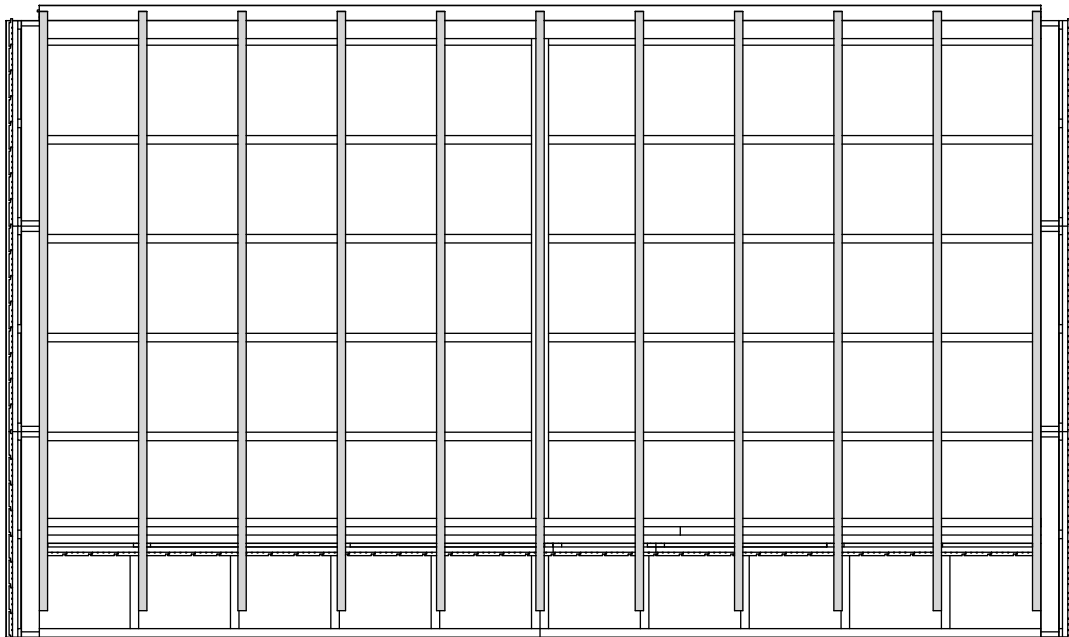

5X80 x6

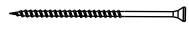

6X120 x11

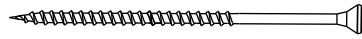

Ø6X160 x33

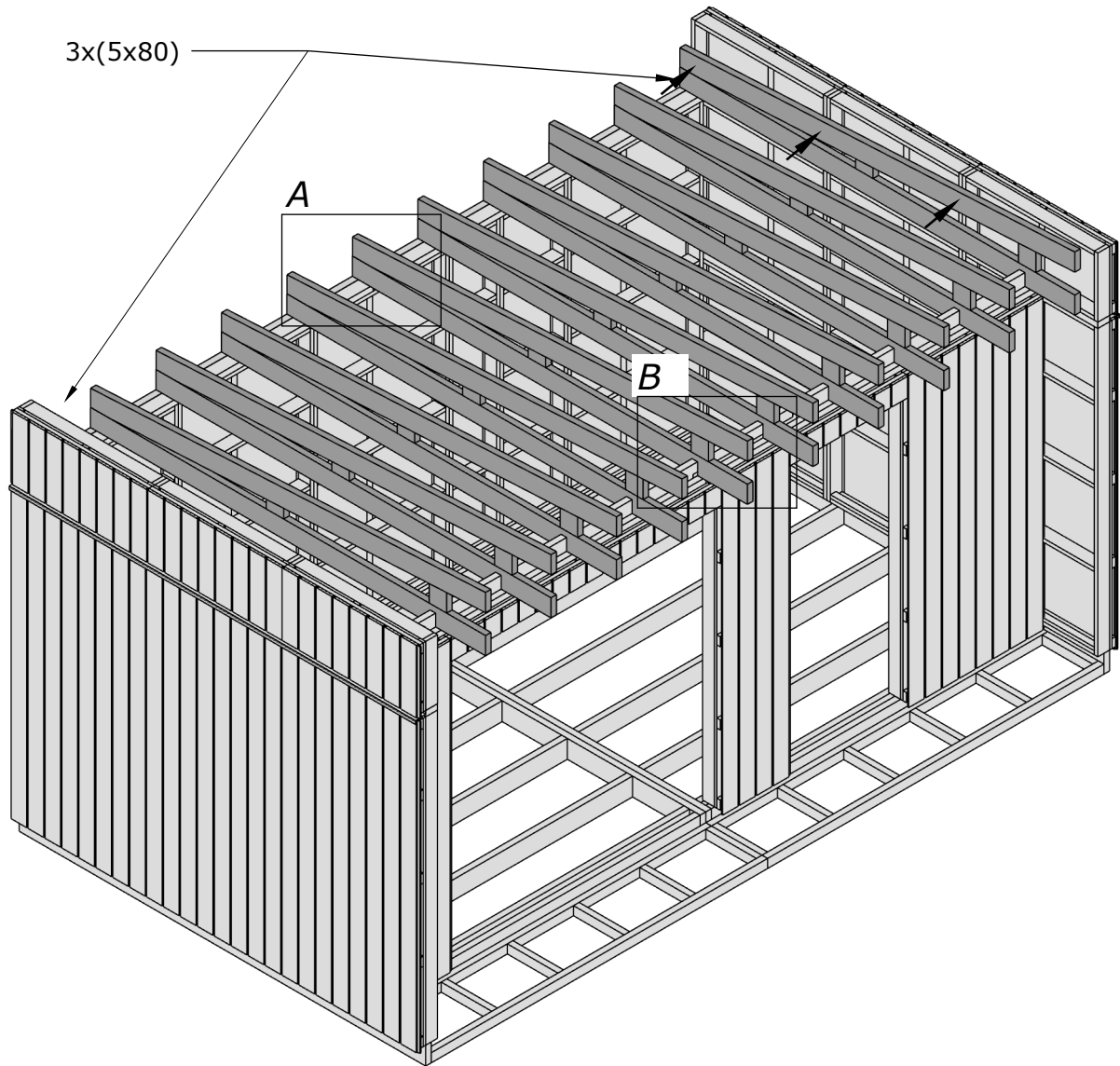
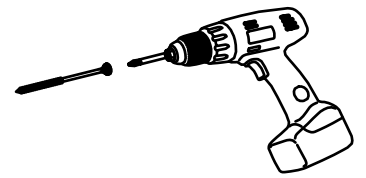
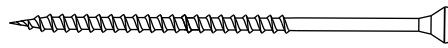

A

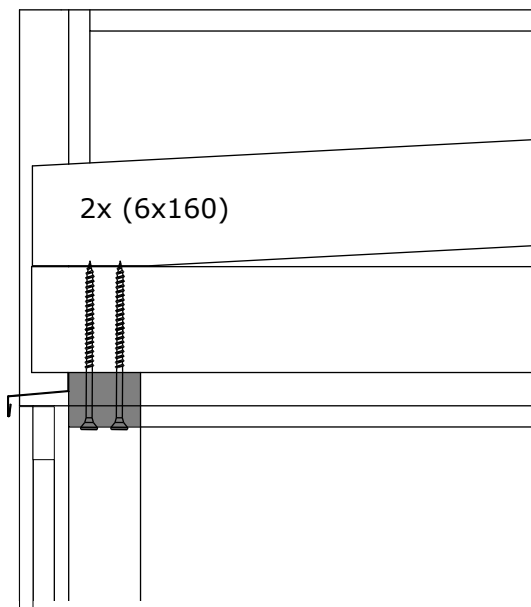

B

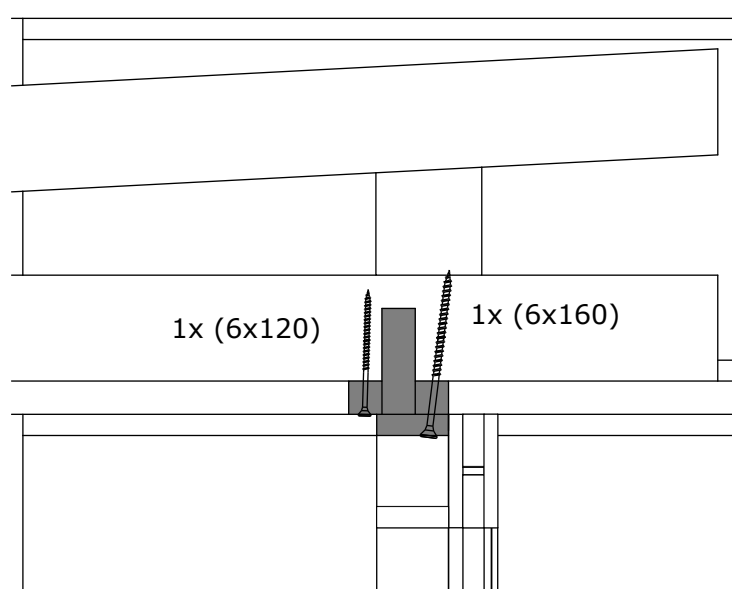

Sla1 x4

Ø5x80 x44

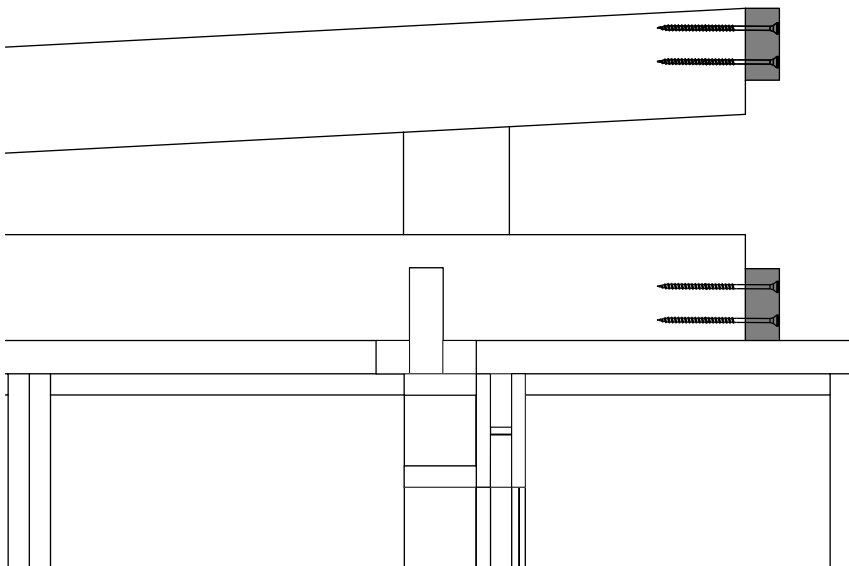
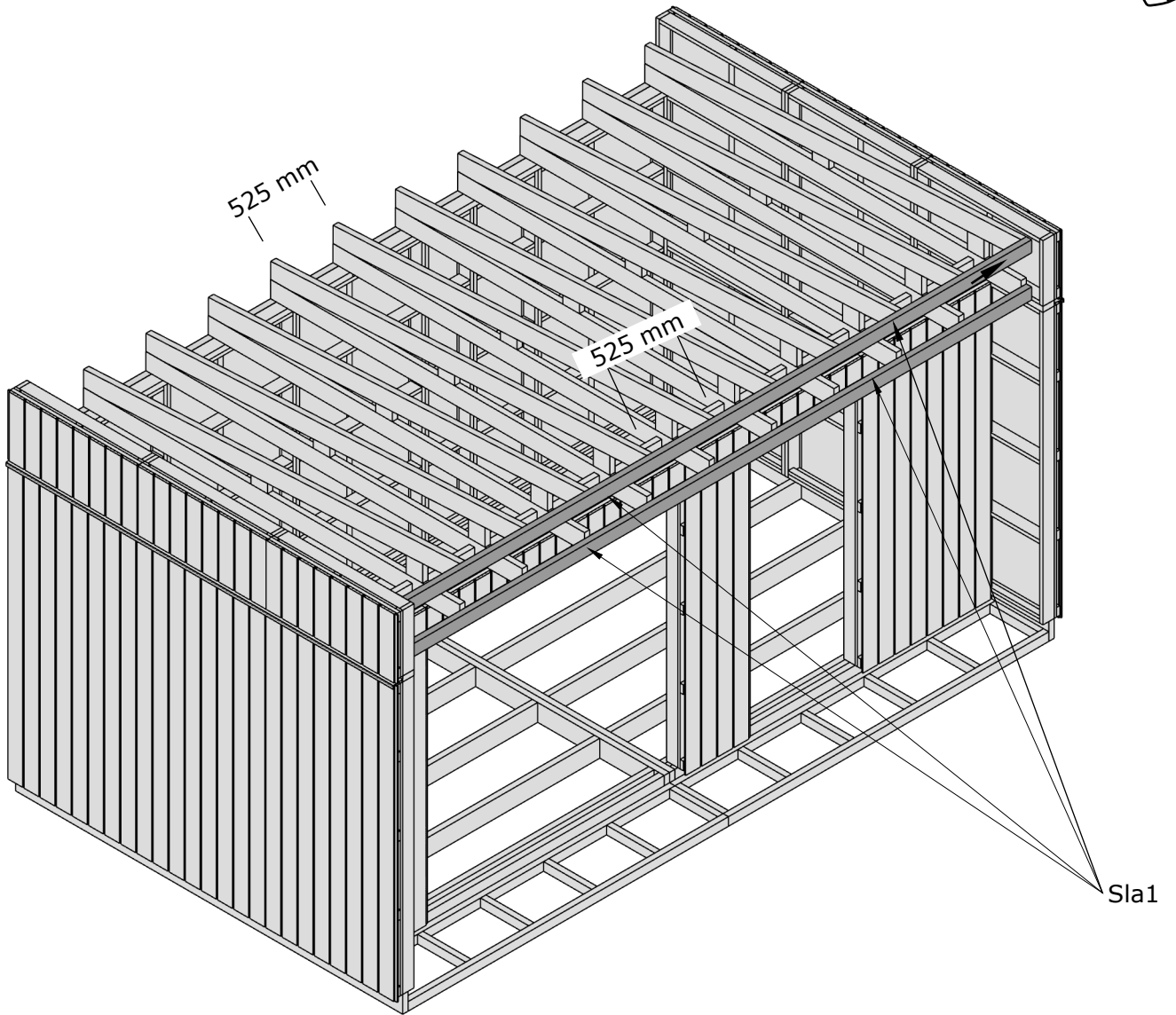
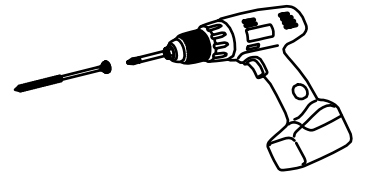

EI9 x4
EI10 x1
EI11 x1

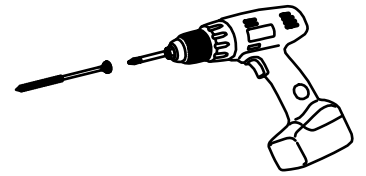

Ø5x80 x44

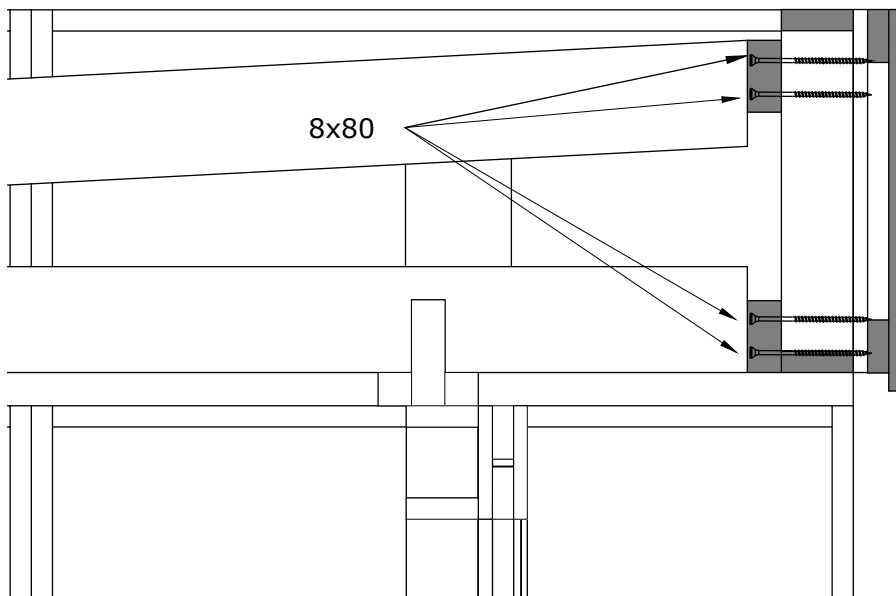
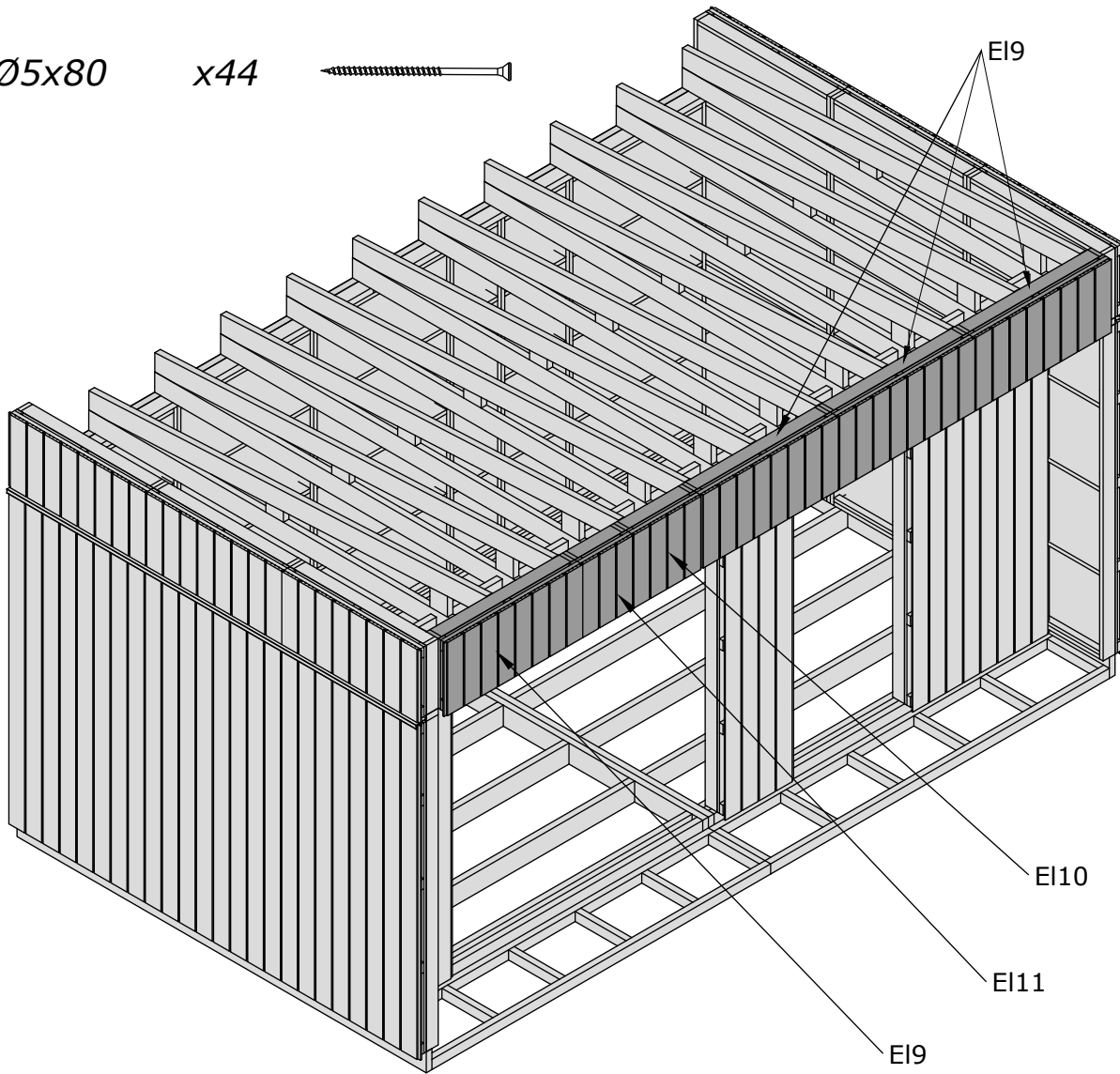
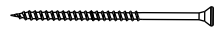

PST1 x4

Ø5x80 x32

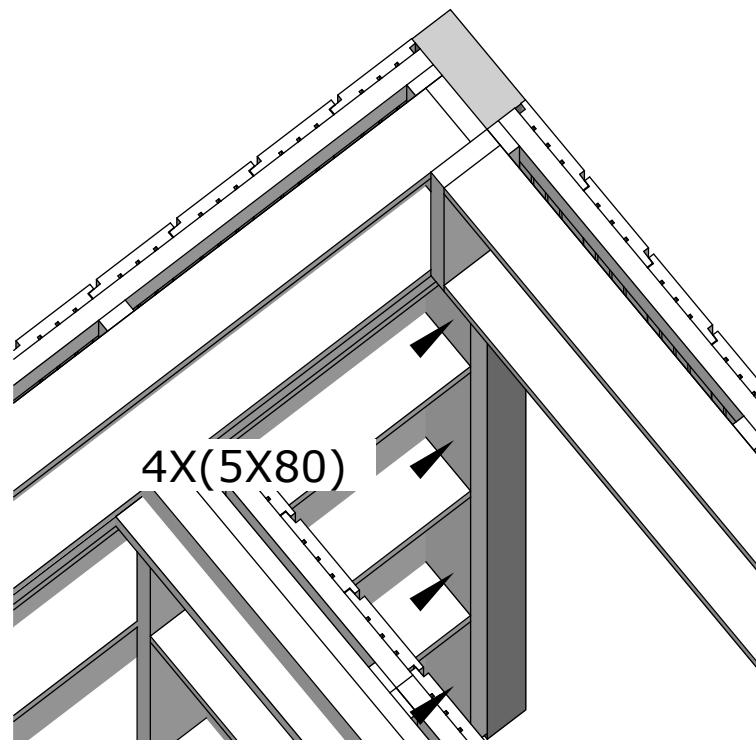
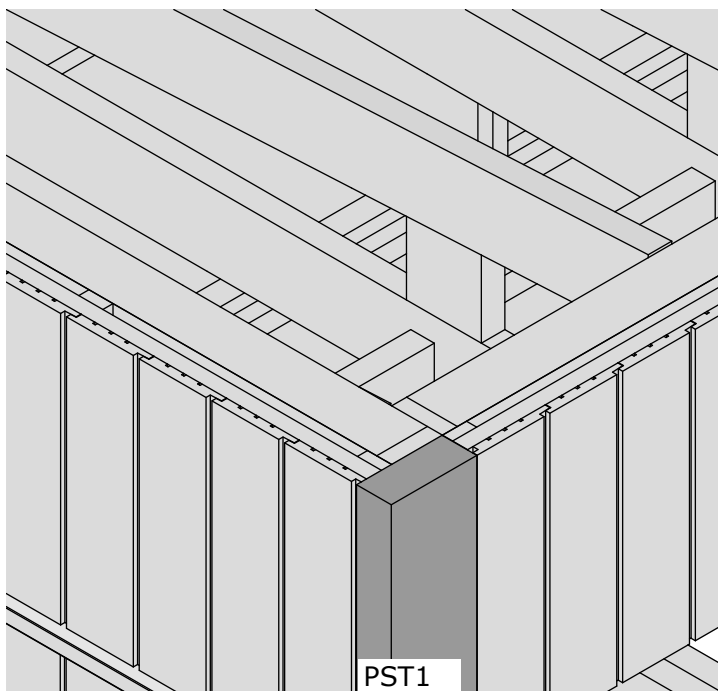
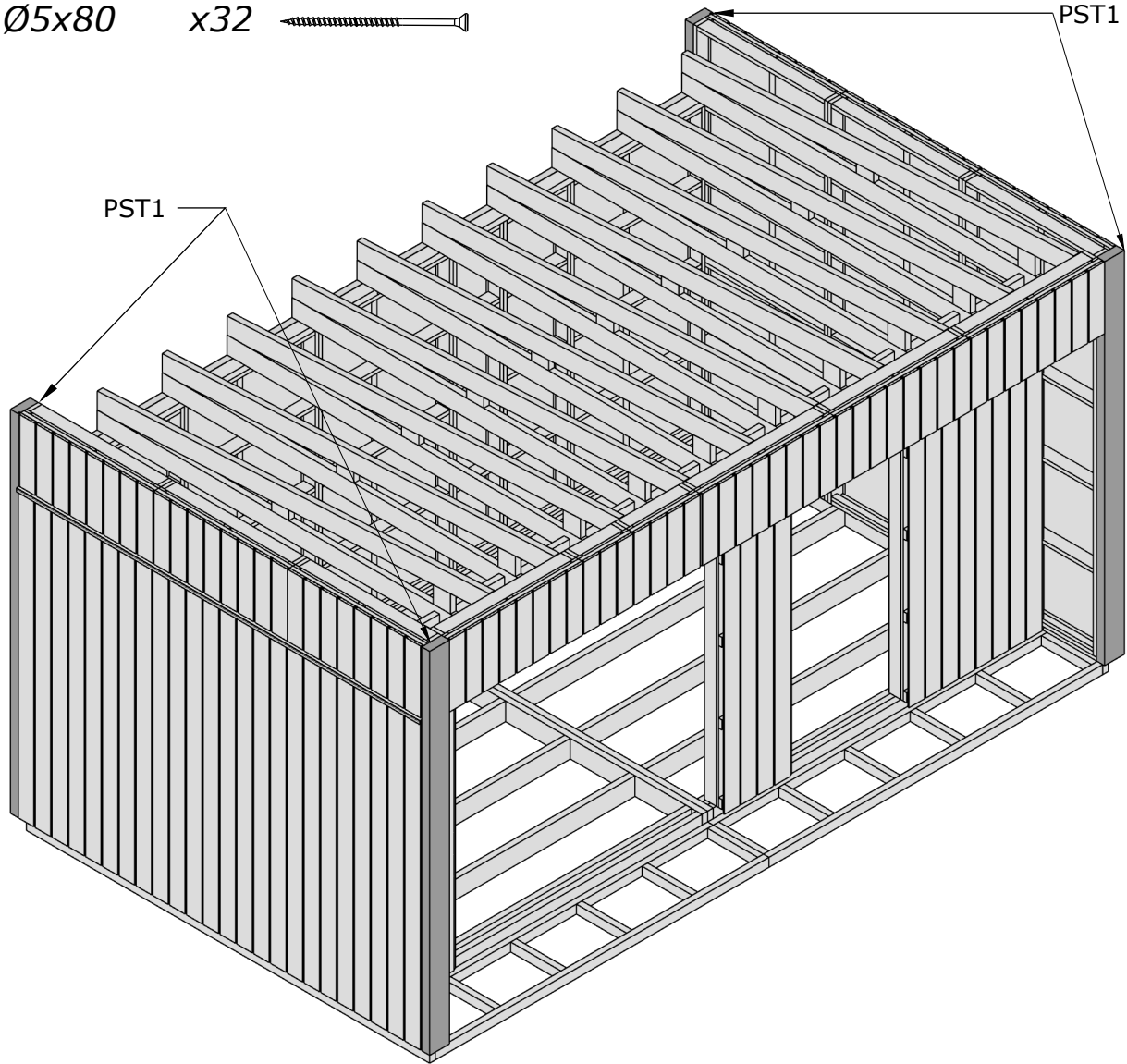
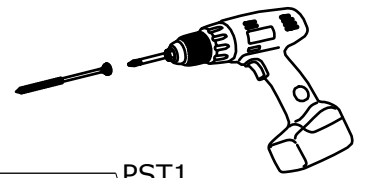

RB2-1 x38

Ø3X70 x500

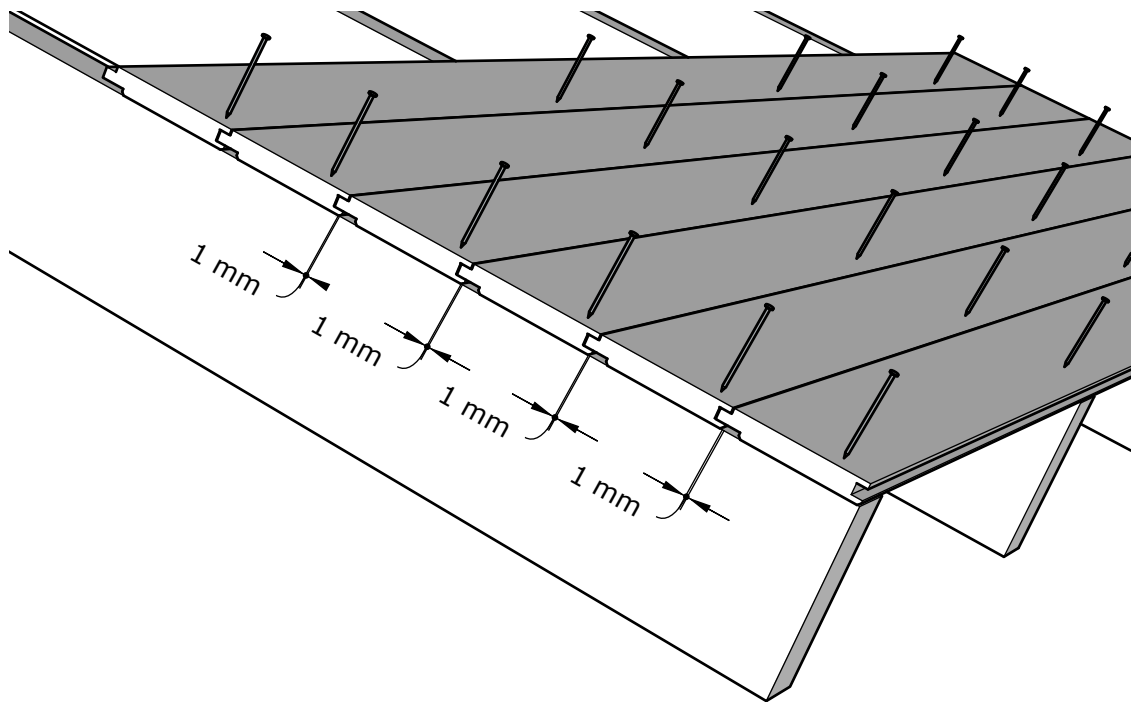
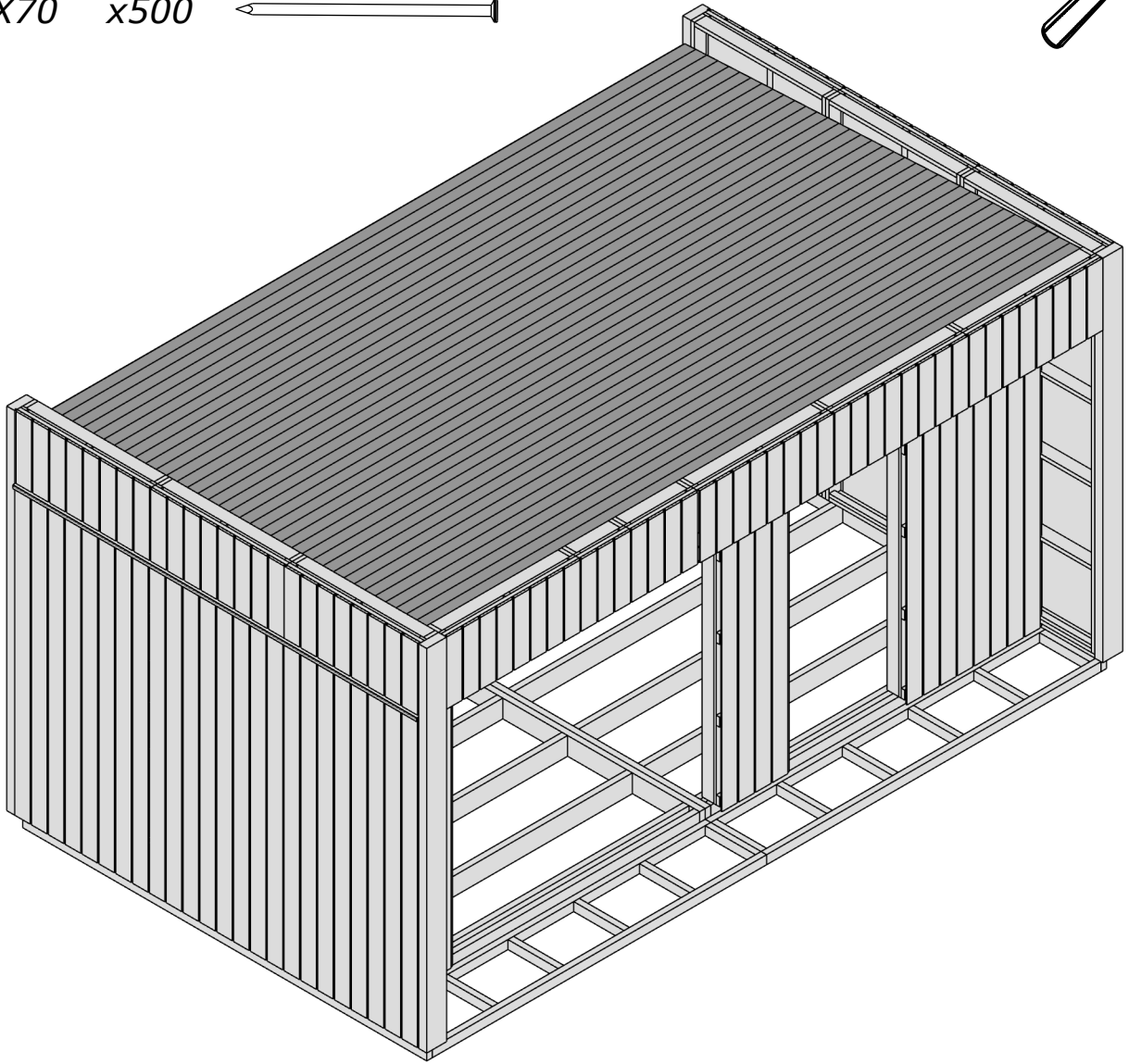
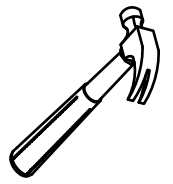
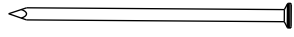

TB1-1 x3

TB1-2 x3

Ø4,5X60 x66

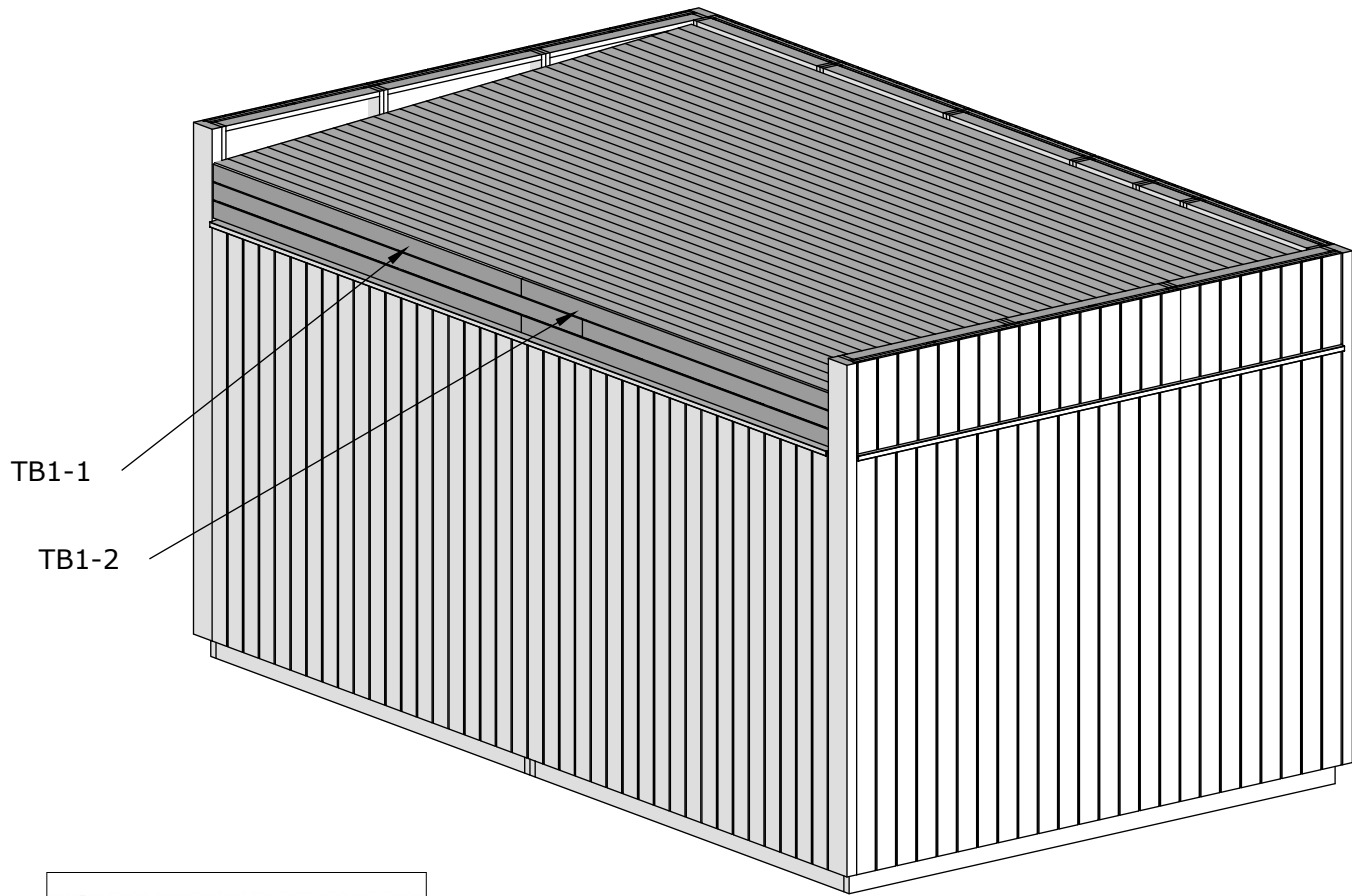
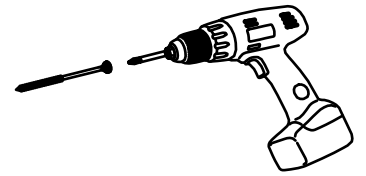
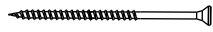

TB1-1

TB1-2

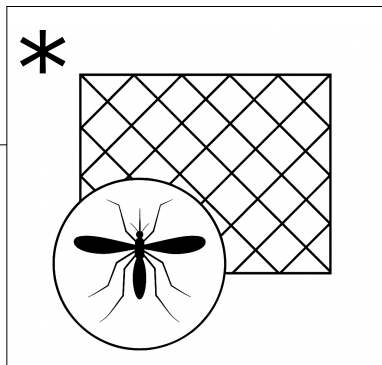

RB2-1

TB1-1 / TB1-2

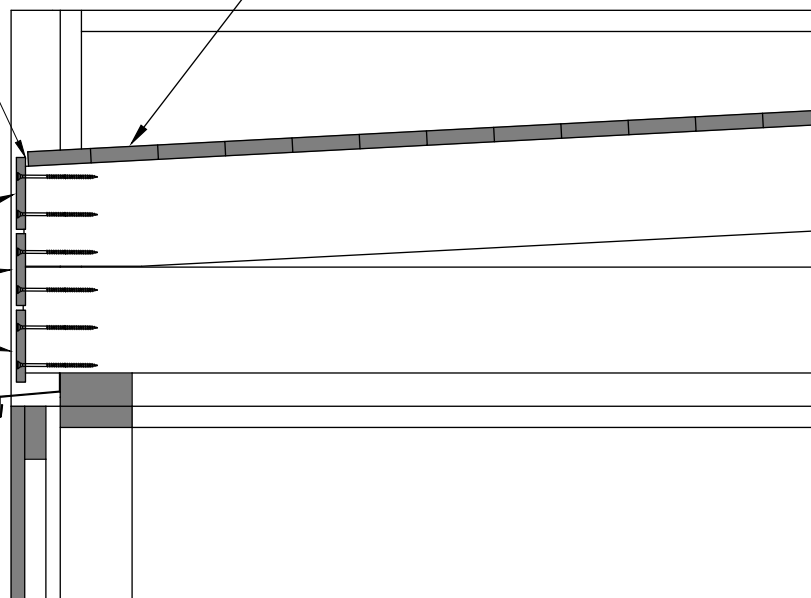

WG10-1 x2

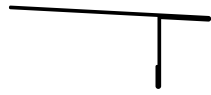

WG10-1

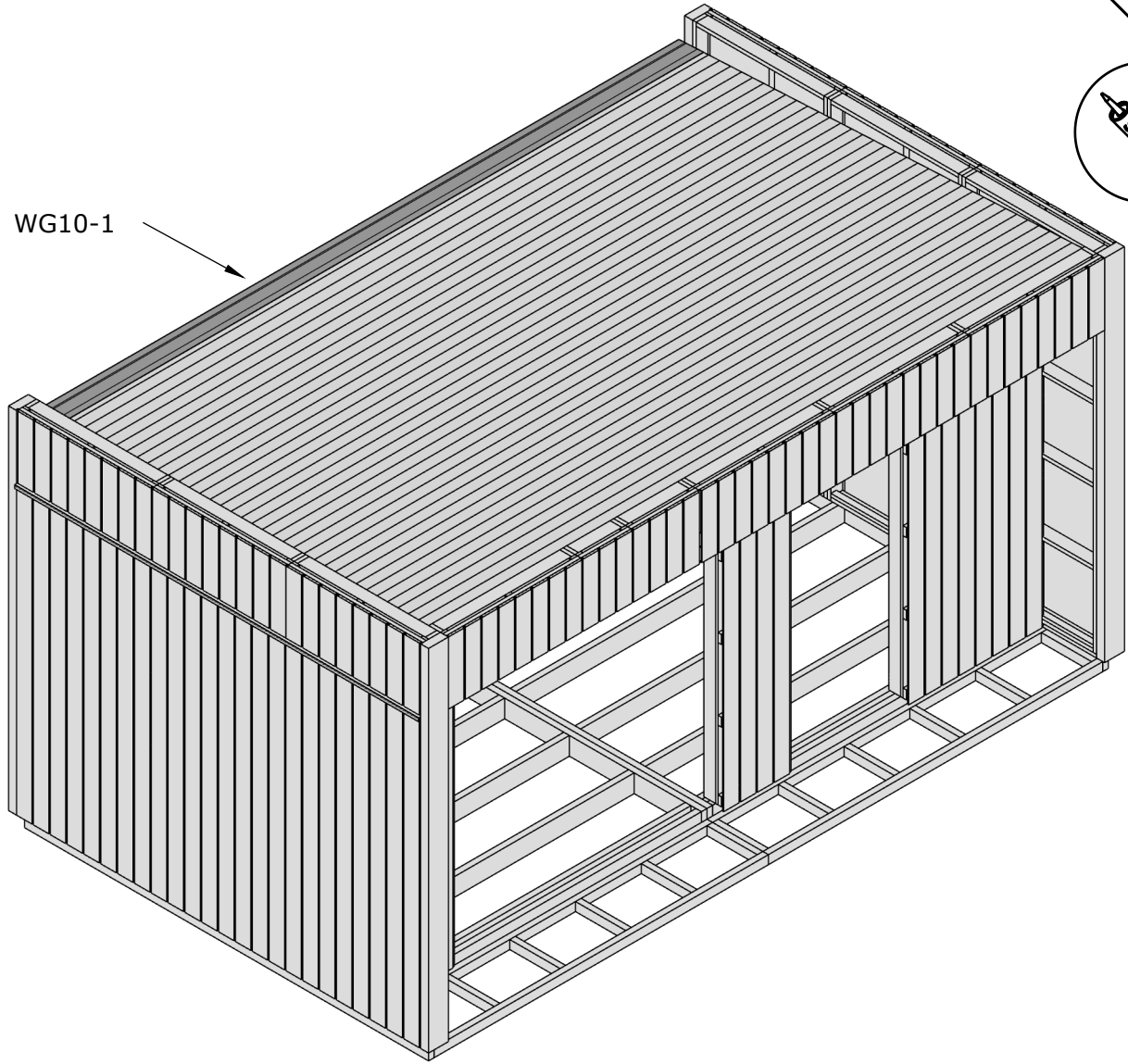

WG10-1

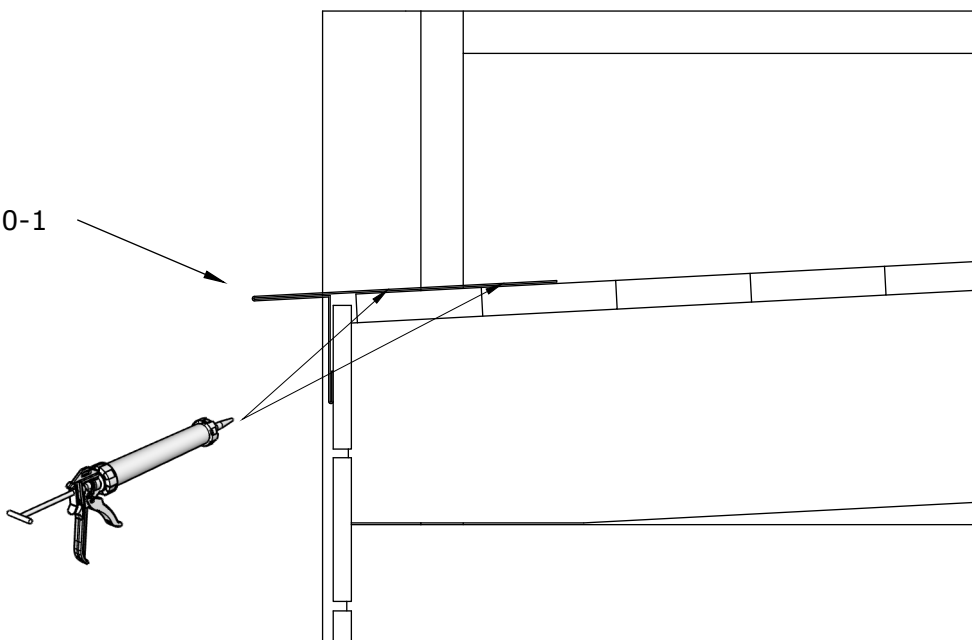

OSB_1 x2
OSB_2 x2

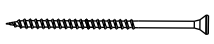
Ø4,5X60 X8 

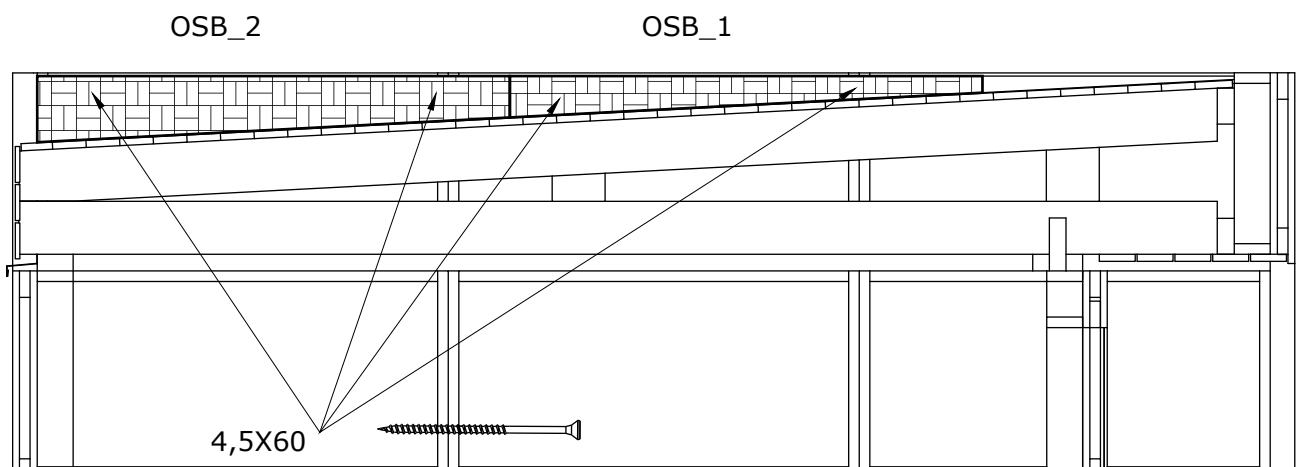
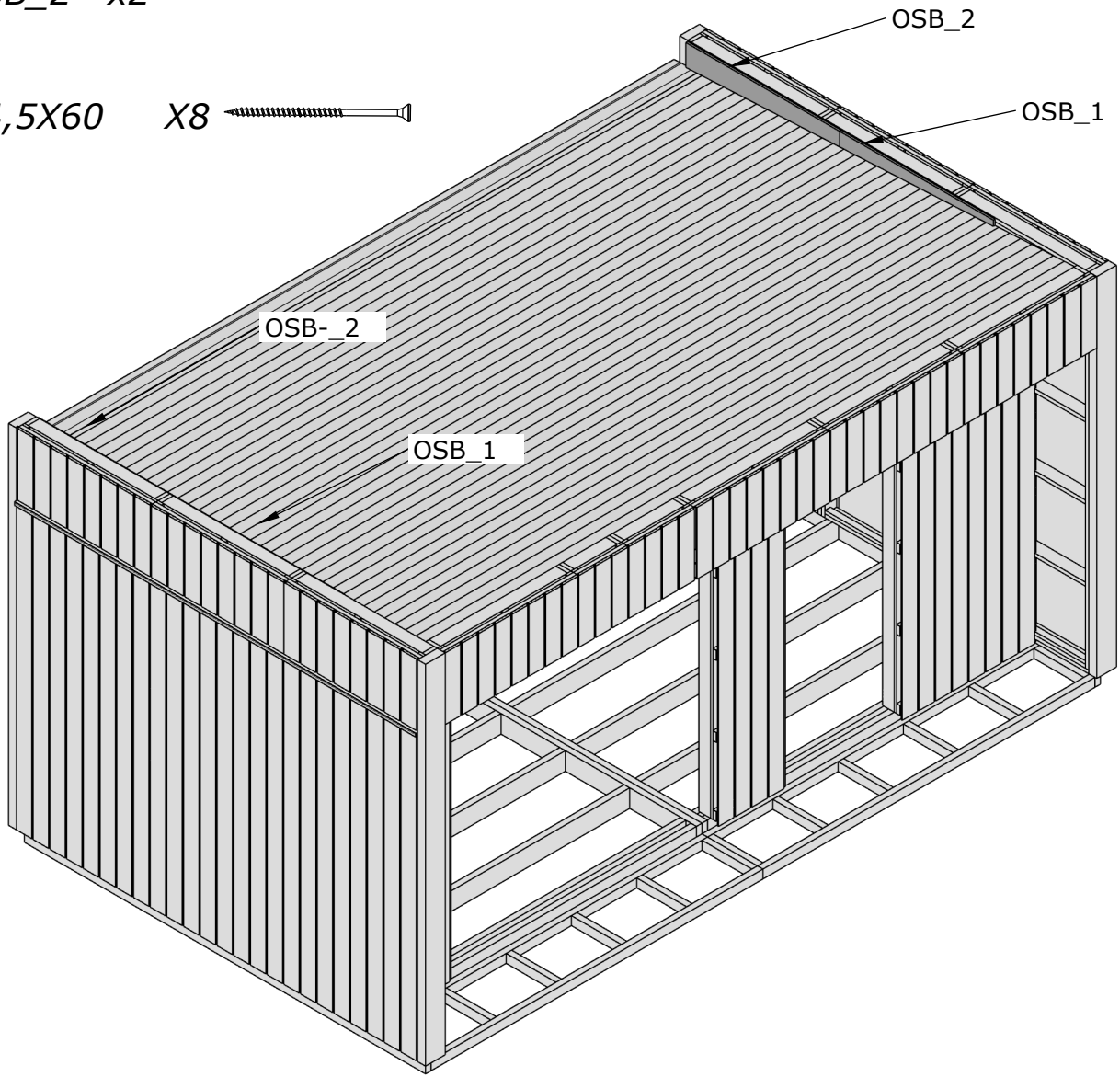

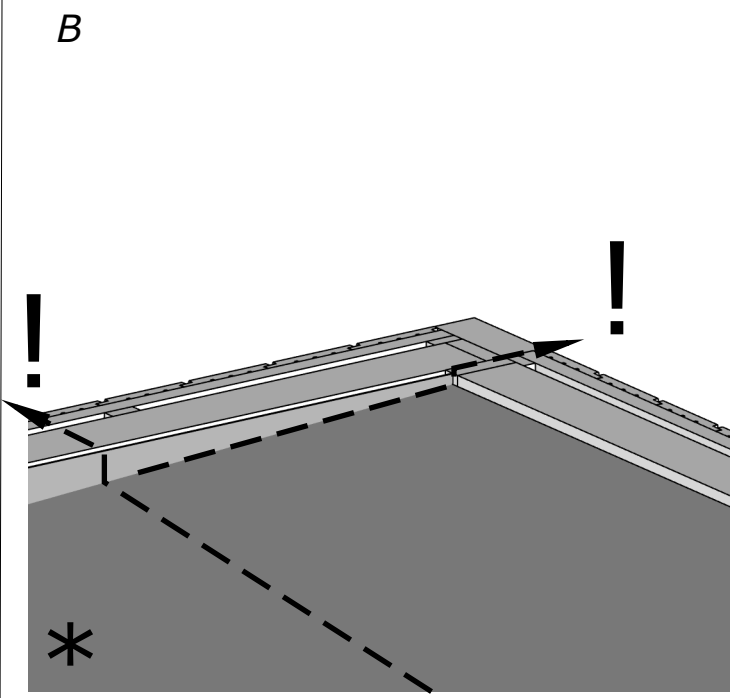
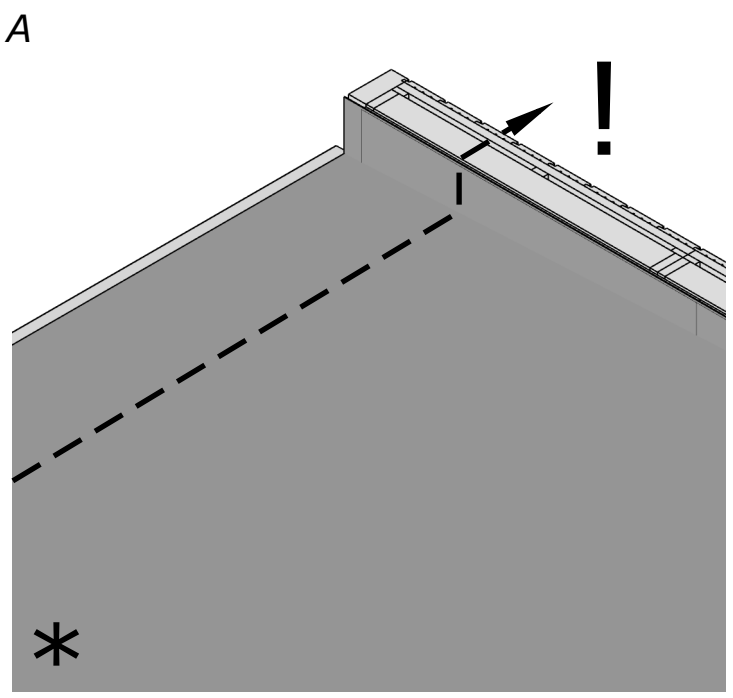
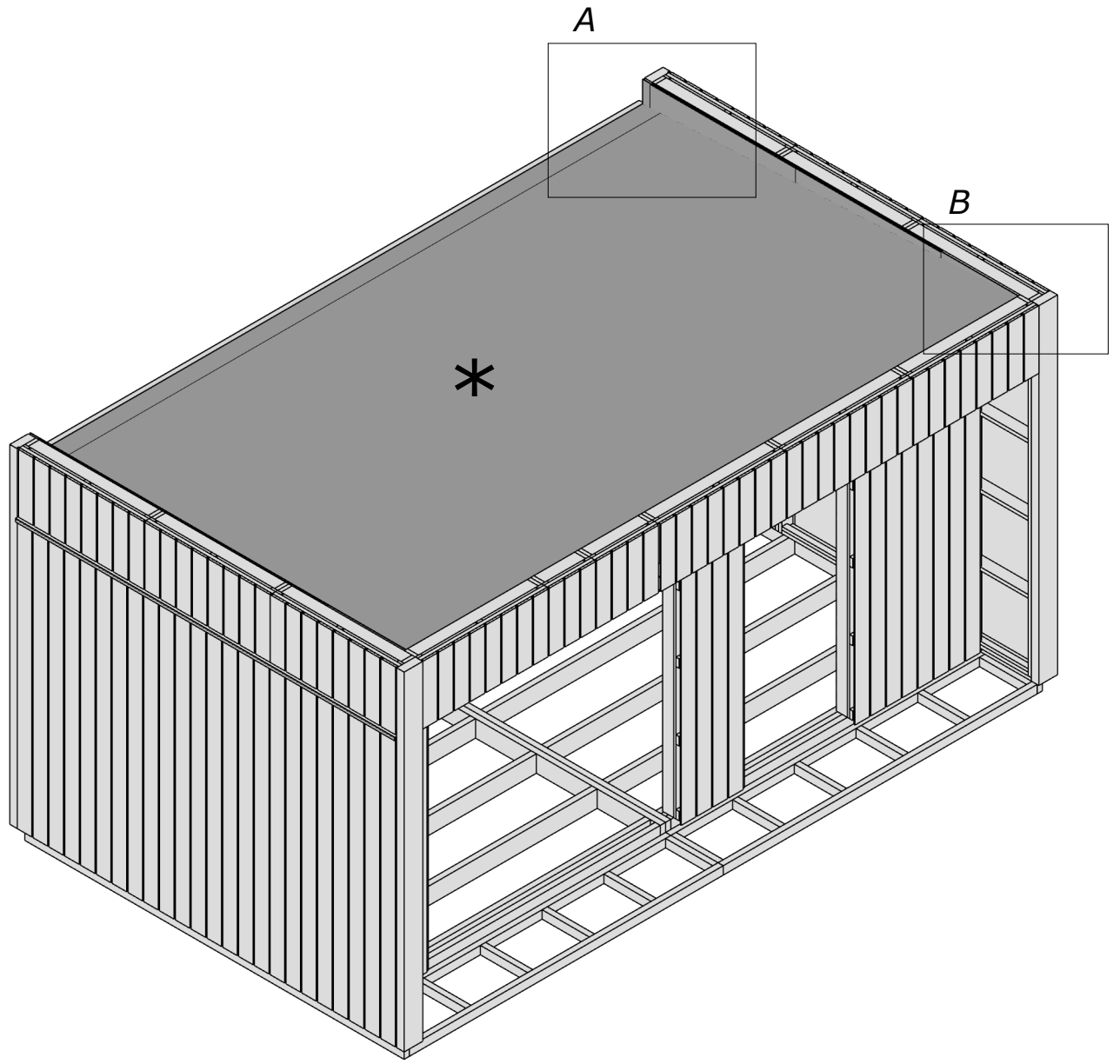

WG7-1 x2
WG7-2 x4

Ø4,8x28 x40

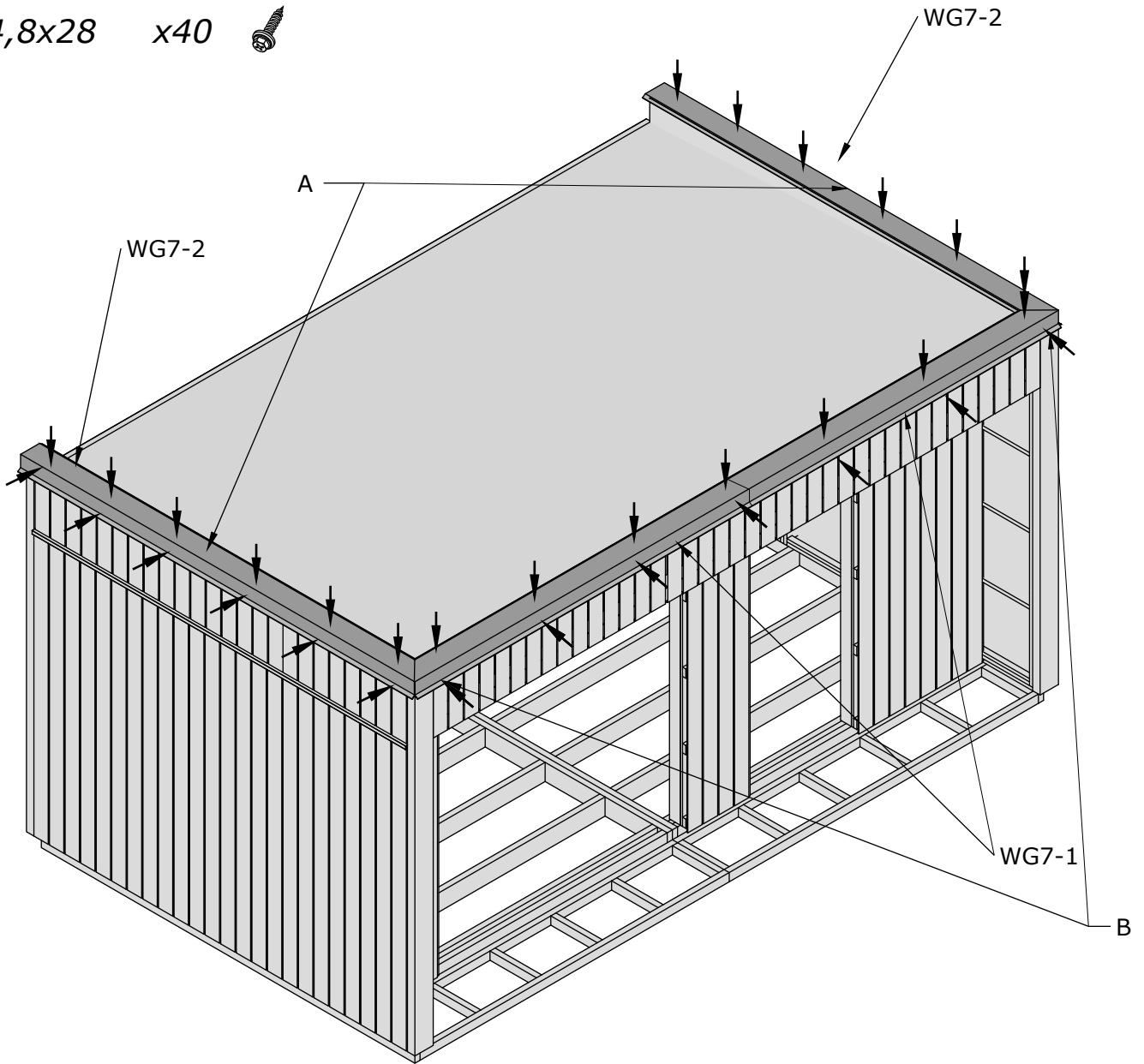
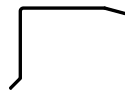

A

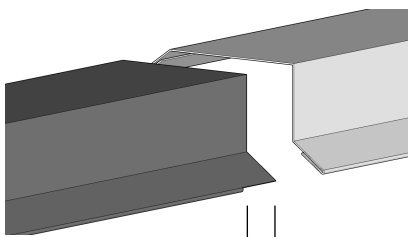

30 mm

B

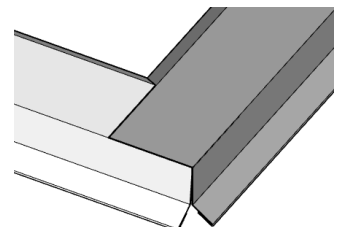
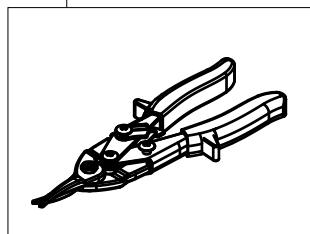
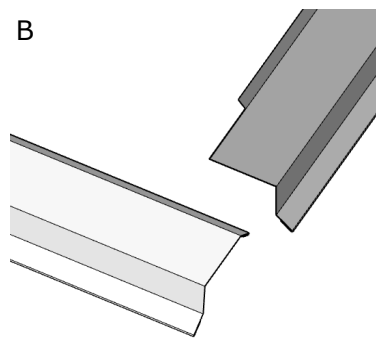

TB1-1 x5

TB1-2 x5

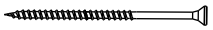
Ø4,5X60 x110 

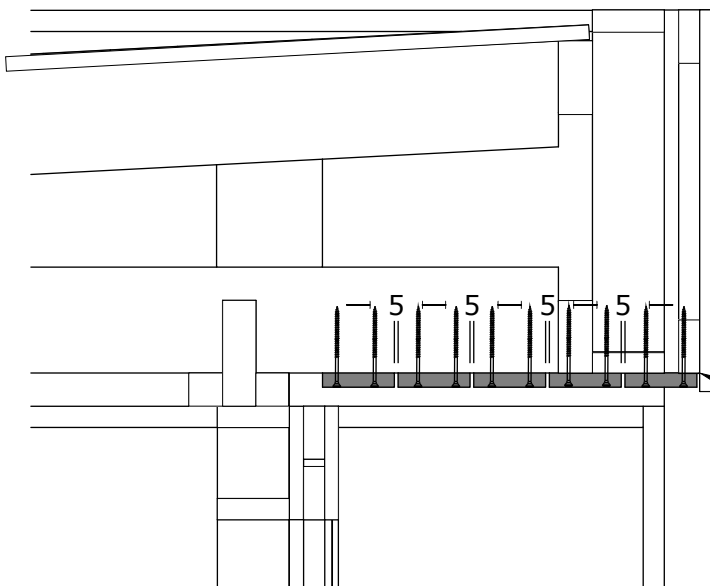
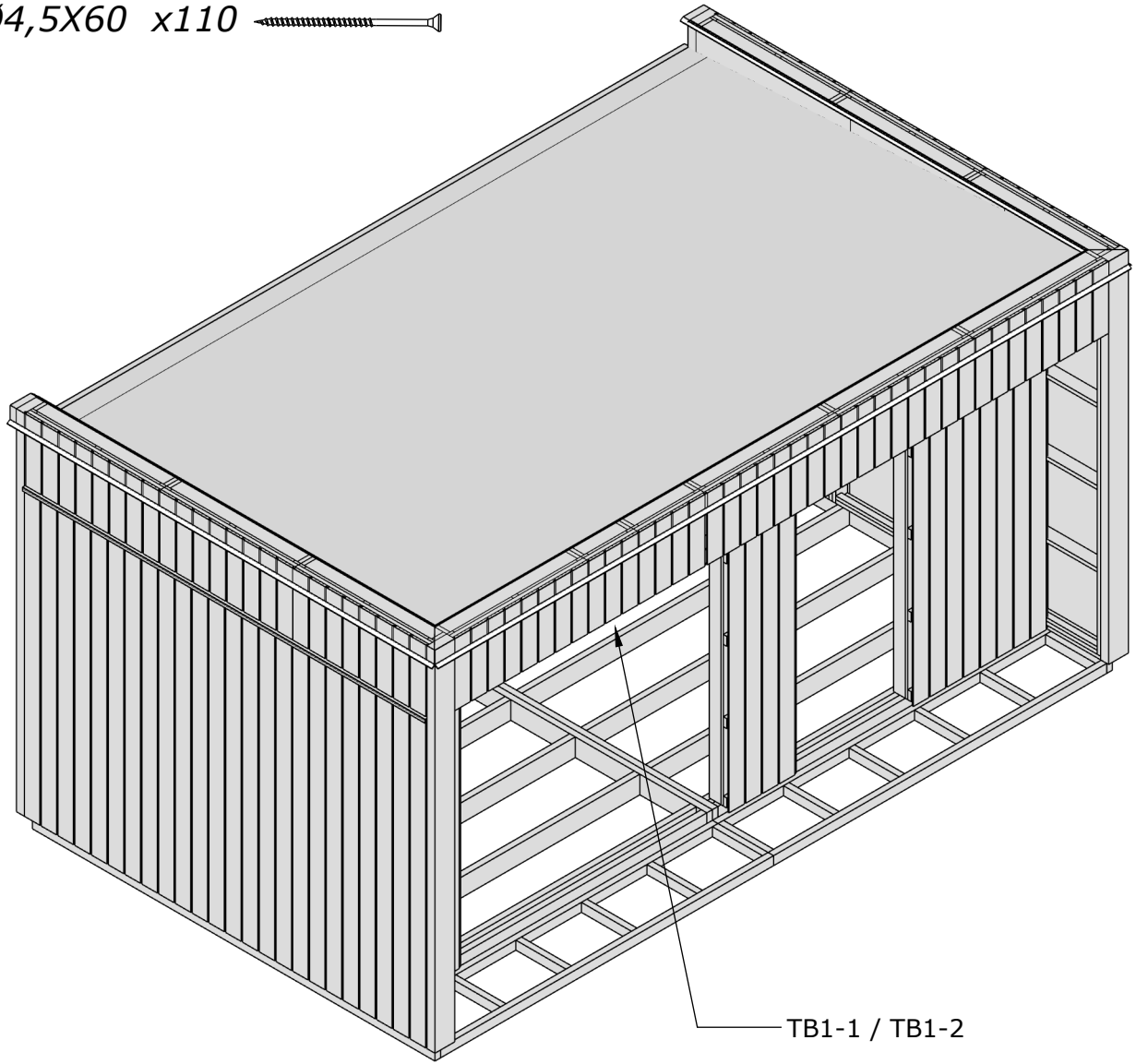

*

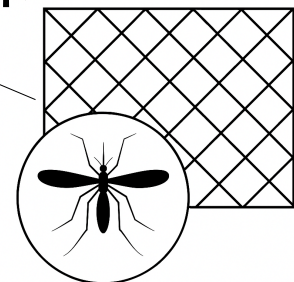

FB2-1 x60

Ø2,5x50 x400

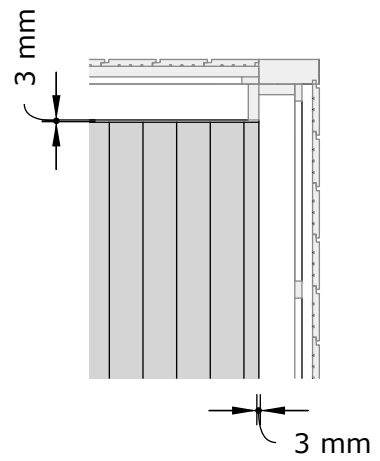
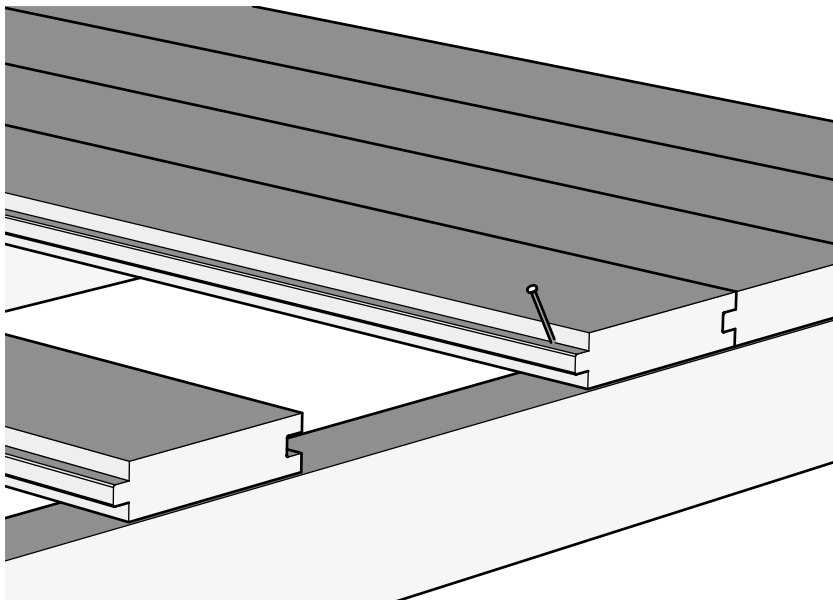
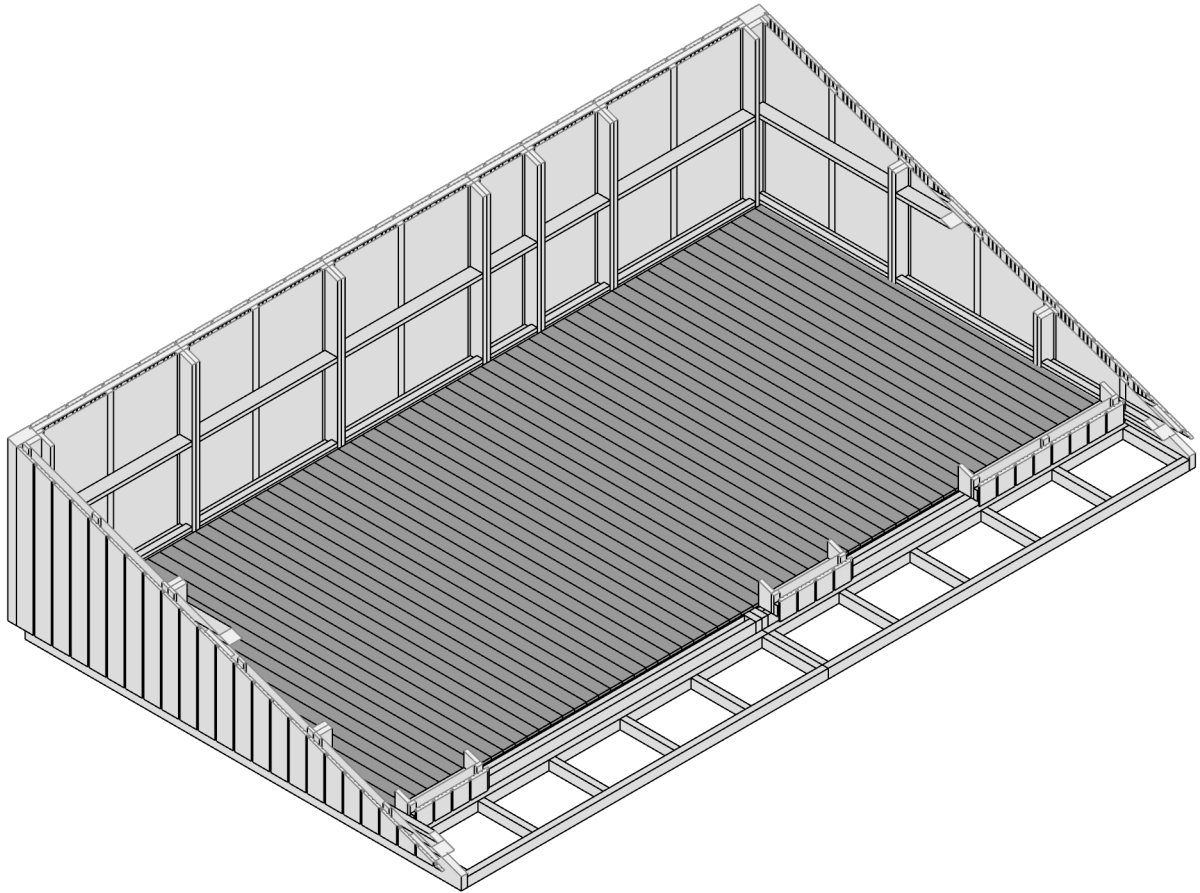
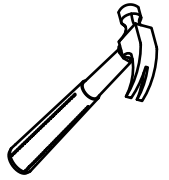
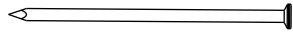

UL4 x1

UL5 x1

Ø2,5x50 x6

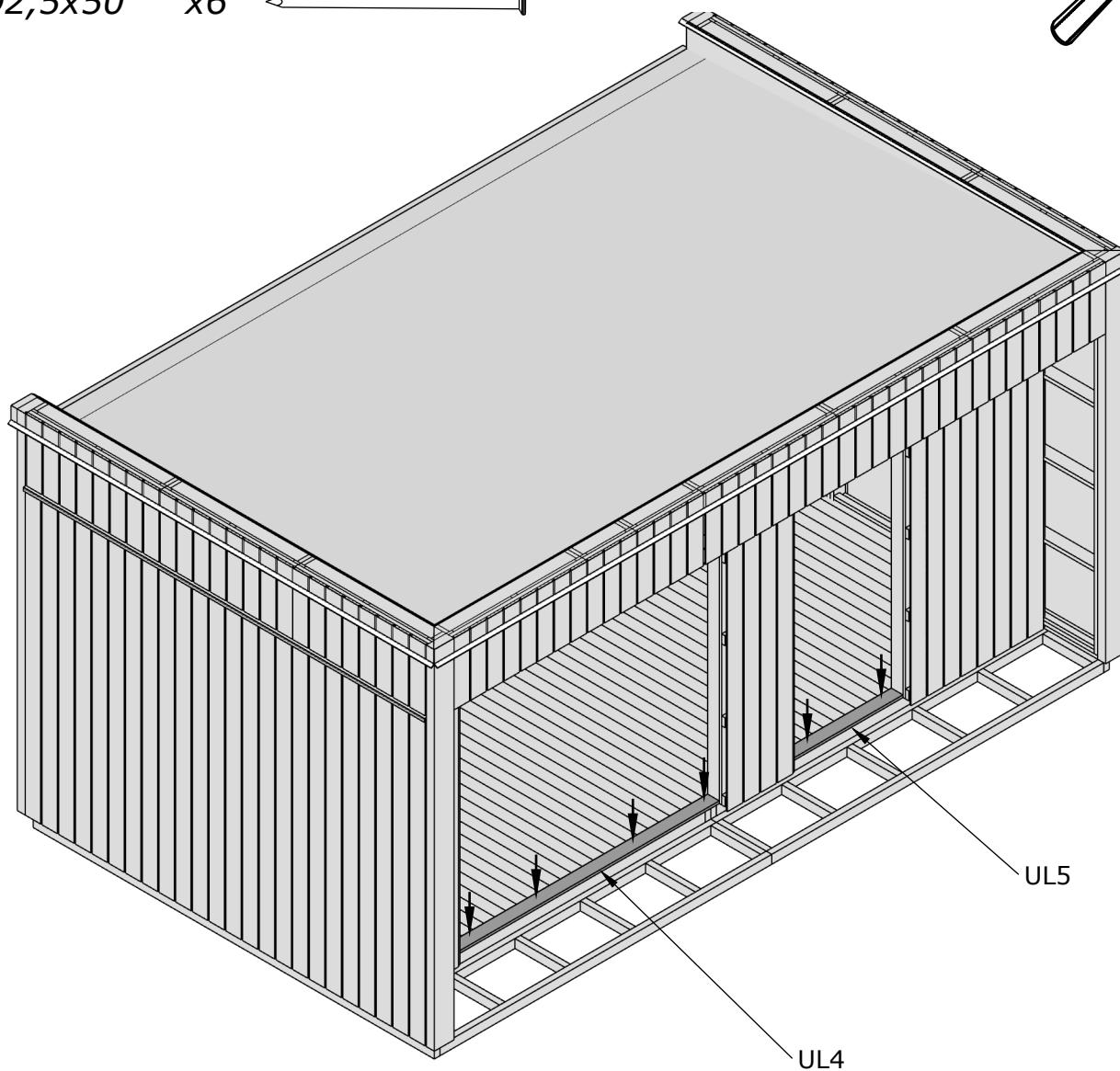
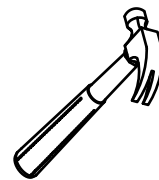
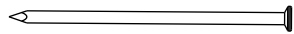

UL5

UL4

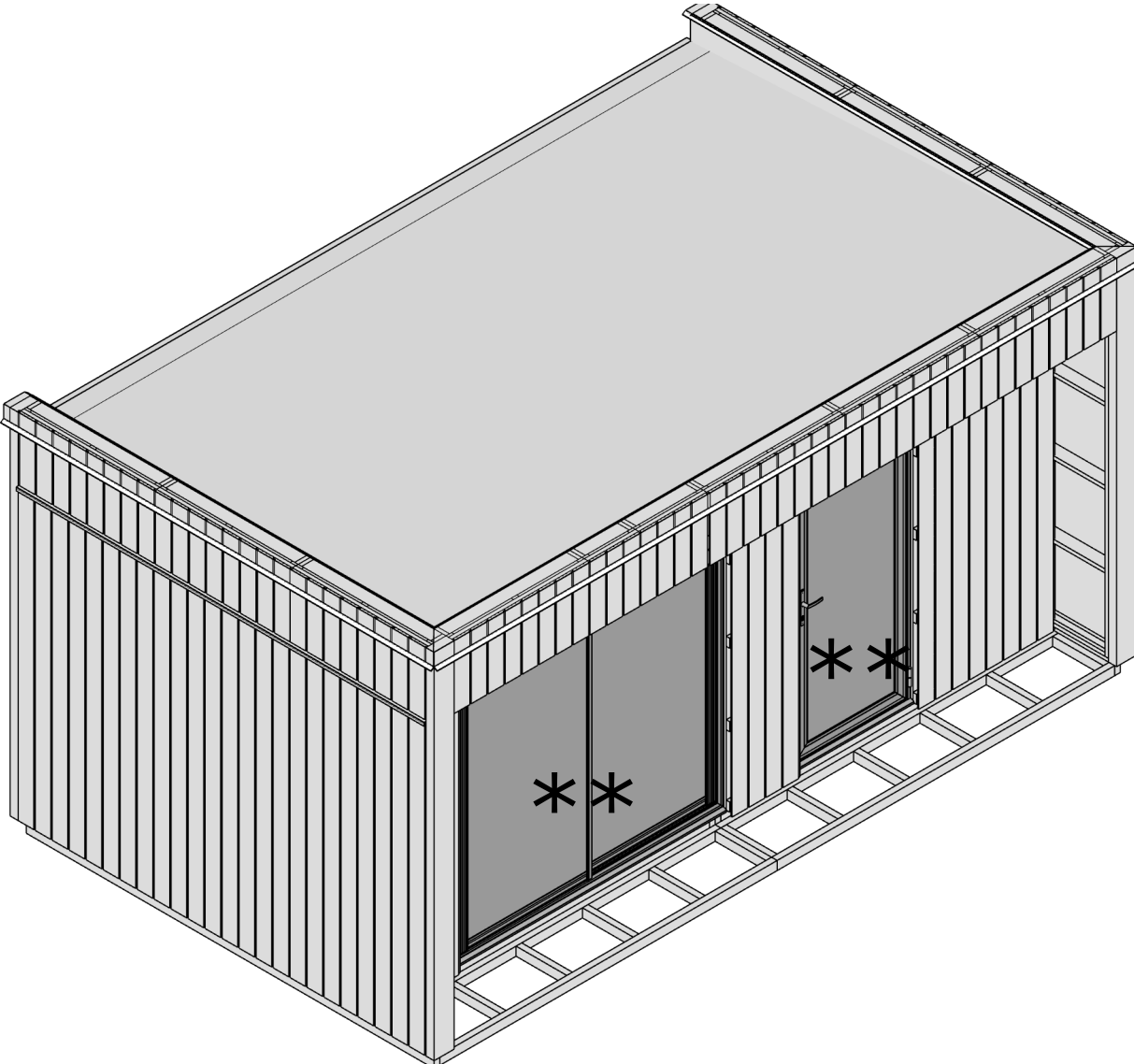

TB2-1 x4
TB2-2 x4

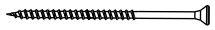
Ø4,5x60 x120 

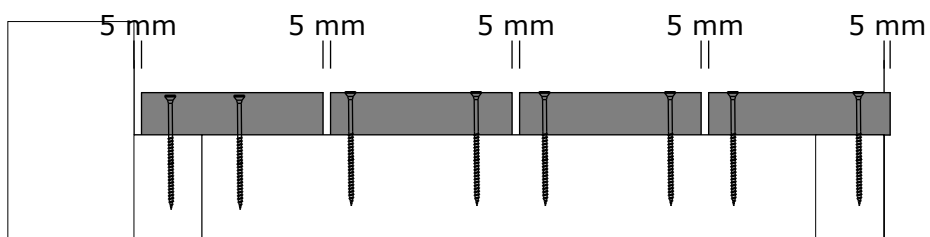
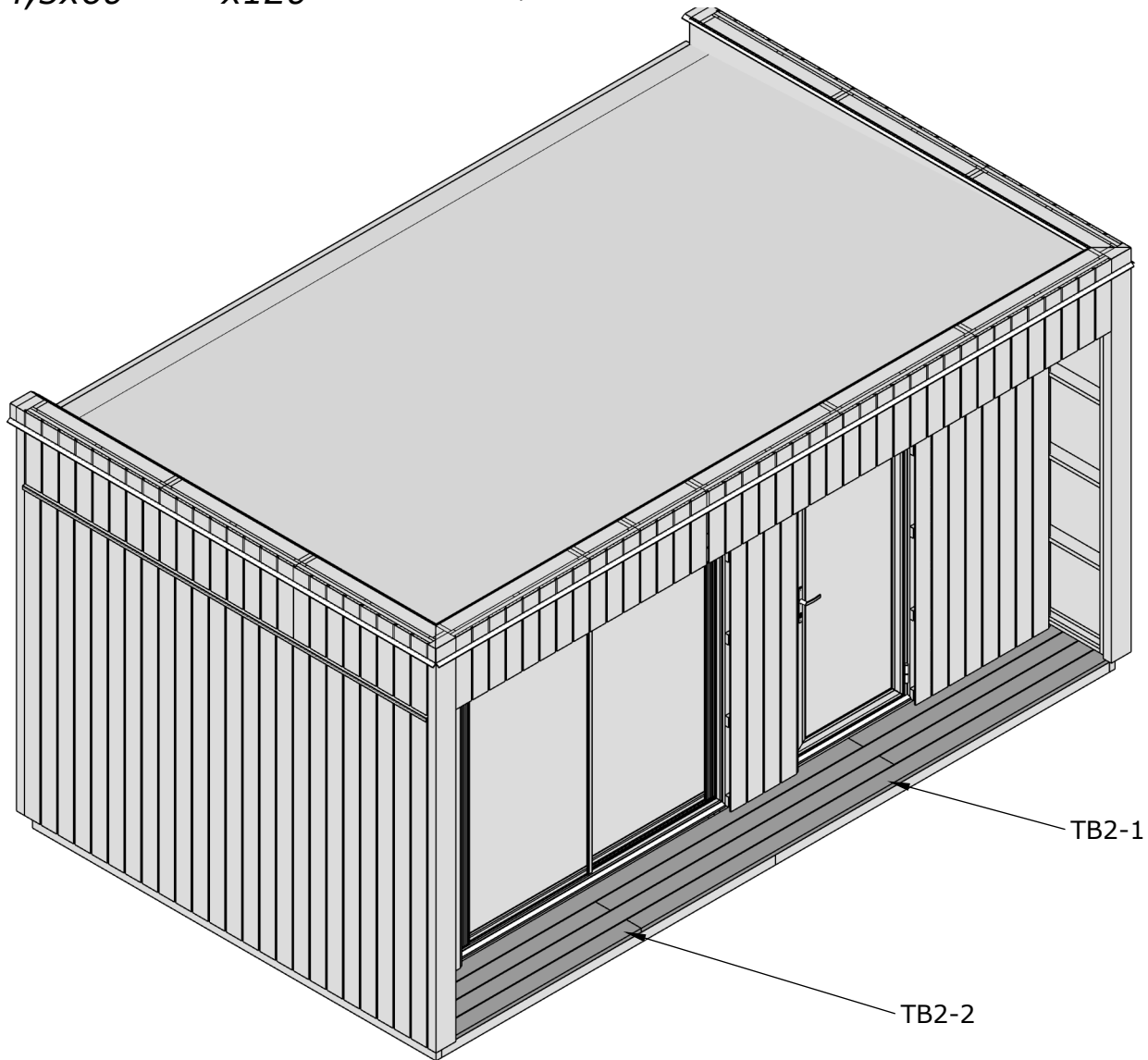

TB1-2 x10

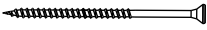
Ø4,5x60 x100 

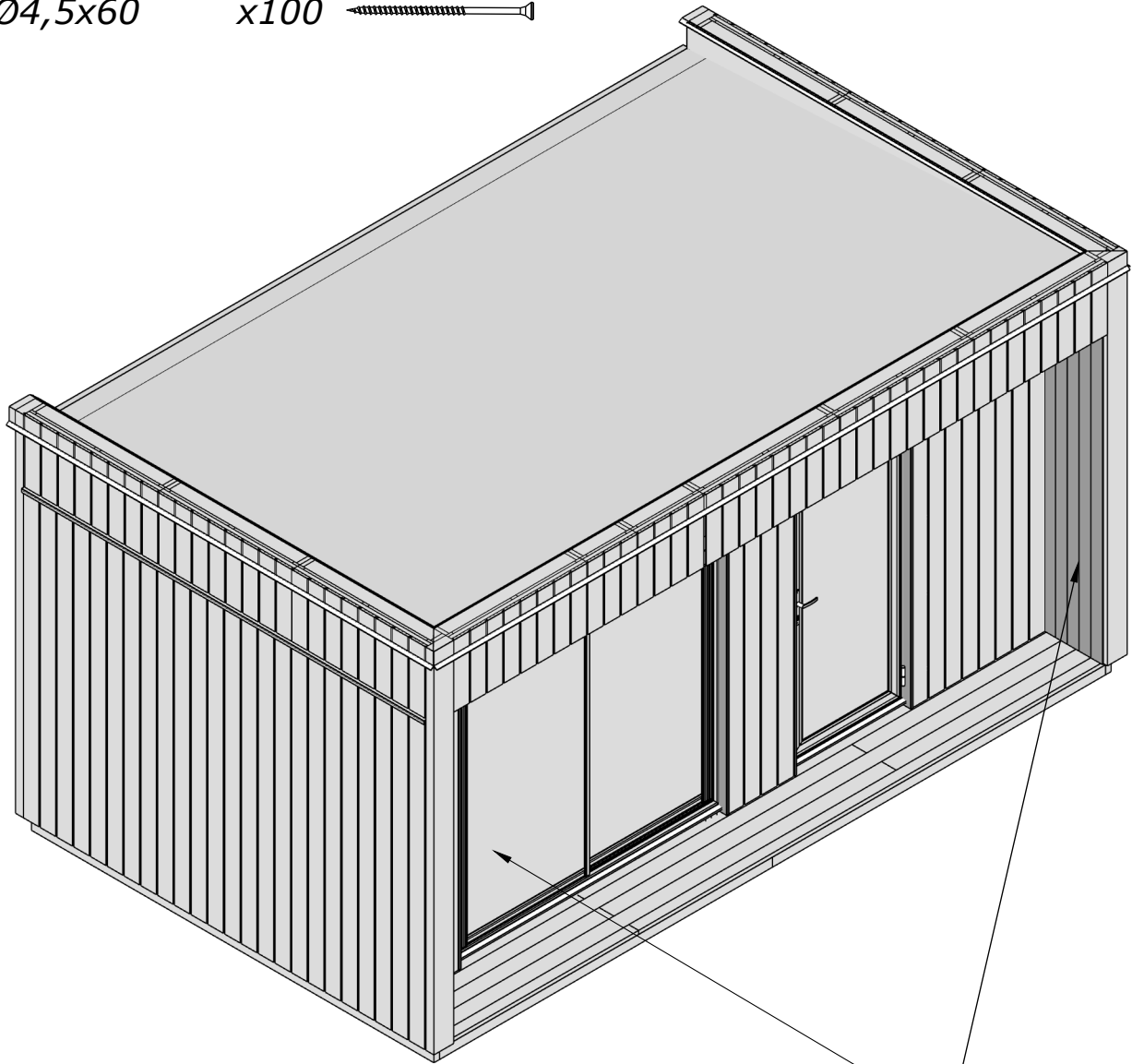
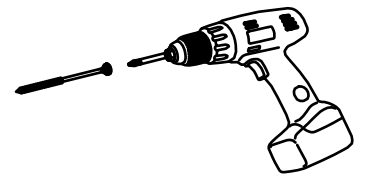

TB1-2

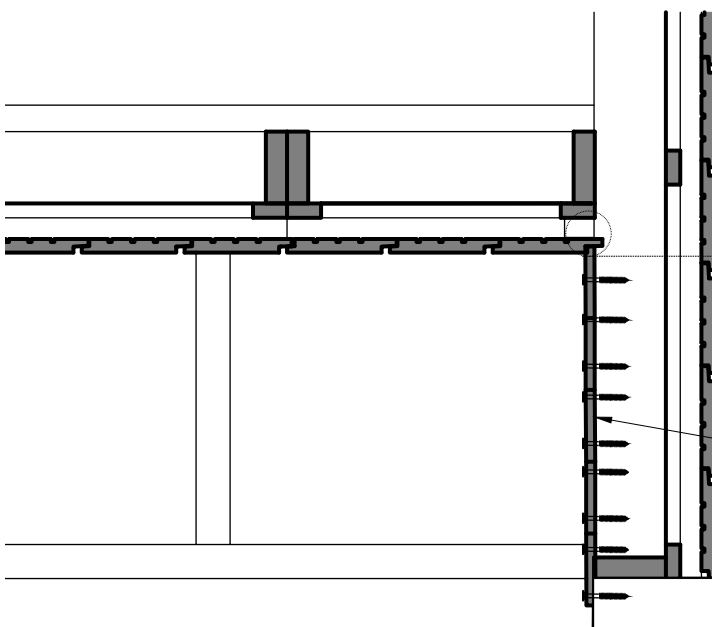

Pst1

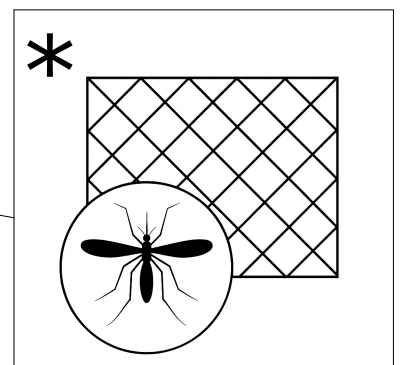
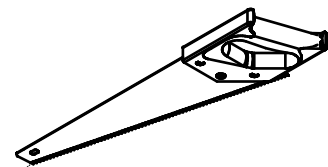

UL1 x4
UL2 x1
UL3 x1

Ø4,5x60 x22 

