

# Assembly, installation and maintenance manual

Montage-, Aufbau- und Wartungsanleitung • Assemblage, manuel de montage et d'entretien • Montaje, instalación y mantenimiento • Manuale di montaggio, installazione e manutenzione • Monterings- og vedlikeholdsmanual • Monterings-, installations- och underhållsmanual • Kokoamis-, asennus- ja huolto-ohje • Vejledning for montering og vedligehold • Handleiding voor montage, installatie en onderhoud • Manual de montagem, instalação e manutenção • Návod k montáži, instalaci a údržbě • Instrukcja montażu, instalacji i konserwacji • Surinkimo, montavimo ir priežiūros vadovas • Montāžas, uzstādīšanas un apkopes rokasgrāmata • Руководство по сборке и обслуживанию • Montaaži-, paigaldus- ja säilitamise juhend



## Pavilion **PA44-3048**

<p><b>Factory inspection by</b> • Werkskontrolle durch • Contrôle à partir de l'usine par • Inspector de fábrica • Collaudato da • Fabrikkontroll utført av • Fabriksbesiktigat av • Tehtaan tarkastaja • Fabriks Kontrol udført af • Fabrikscontrole door • Inspeção de fábrica, por: • Zkontrolováno ve výrobním závodě • Kontrola fabryczna do • Apžiūrą gamykloje atliko • Rūpnīcas pārbaudi veicis • Заводской контроль • Tehase kontroll teostatud:</p> <p>.....</p>	<p><b>Date</b> • Datum • Date • Fecha • Data • Dato • Datum • Päiväys • Dato • Datum • Data • Datum • Data • Datums • Data • Дата • Kuupäev:</p>
	<p><b>Pack number</b> • Pack Nr. • Packet n° • Bulto N° • Pacco N. • Serienr • Produktionsnummer • Pakettinro • Pakke nr. • Pak nr. • Número de embalagem • Číslo balení • Numer opakowania • Pakuotės numeris • Iepakojuma numurs • Упаковочный номер • Pakinumber:</p>



[www.palmako.ee/information-hub](http://www.palmako.ee/information-hub)

**English:** Before installing and using the product, please read the instructions and warranty terms at [www.palmako.ee/information-hub](http://www.palmako.ee/information-hub) to guarantee proper installation and long-lasting performance.

**Deutsch:** Wichtig! Bitte vor Aufbau und Nutzung des Produkts unbedingt die detaillierte Montageanleitung sowie die Garantiebedingungen unter [www.palmako.ee/information-hub](http://www.palmako.ee/information-hub) lesen, um eine fachgerechte Montage und eine lange Funktionssicherheit zu gewährleisten.

**Français:** Avant d'installer et d'utiliser le produit, veuillez lire les instructions et les conditions de garantie sur [www.palmako.ee/information-hub](http://www.palmako.ee/information-hub) afin de garantir une installation correcte et la longévité du produit.

**Español:** Antes de instalar y utilizar el producto, lea las instrucciones y las condiciones de garantía en [www.palmako.ee/information-hub](http://www.palmako.ee/information-hub) para asegurar una instalación correcta y una larga vida útil del producto.

**Italiano:** Prima di installare e utilizzare il prodotto, leggere le istruzioni e le condizioni di garanzia su [www.palmako.ee/information-hub](http://www.palmako.ee/information-hub) per garantire una corretta installazione e prestazioni durature.

**Norsk:** Før montering og bruk av produktet, vennligst les monteringsanvisningene og garantivilkårene på [www.palmako.ee/information-hub](http://www.palmako.ee/information-hub) for å sikre korrekt montering og fremtidig holdbarhet.

**Svenska:** Innan du installerar och använder produkten, vänligen läs instruktionerna och garantivillkoren på [www.palmako.ee/information-hub](http://www.palmako.ee/information-hub) för att säkerställa korrekt installation och produktens långvariga hållbarhet

**Suomi:** Ennen tuotteen asentamista ja käyttämistä, lue ohjeet ja takuehdot osoitteessa [www.palmako.ee/information-hub](http://www.palmako.ee/information-hub) varmistaaksesi oikean asennuksen ja pitkäkestoisen toiminnan.

**Русский:** Перед установкой и использованием изделия ознакомьтесь с инструкцией и условиями гарантии на сайте [www.palmako.ee/information-hub](http://www.palmako.ee/information-hub), чтобы гарантировать правильную установку и долговечность изделия.

**Eesti:** Enne toote paigaldamist ja kasutuselevõttu lugege palun juhiseid ja garantiitingimusi aadressil [www.palmako.ee/information-hub](http://www.palmako.ee/information-hub), et tagada nõuetekohane paigaldus ja toote pikk eluiga.

**Dansk (Oversat af AI):** Læs venligst instruktionerne og garantibetingelserne på [www.palmako.ee/information-hub](http://www.palmako.ee/information-hub), før du installerer og bruger produktet, for at garantere korrekt installation og langvarig ydeevne.

**Dutch (Vertaald door AI):** Lees vóór de installatie en het gebruik van het product de instructies en garantievoorwaarden op [www.palmako.ee/information-hub](http://www.palmako.ee/information-hub) om een correcte installatie en langdurige werking te garanderen

**Português (Traduzido por IA):** Antes de instalar e utilizar o produto, leia as instruções e os termos de garantia em [www.palmako.ee/information-hub](http://www.palmako.ee/information-hub) para garantir uma instalação adequada e um desempenho duradouro.

**Čeština (Přeloženo umělou inteligencí):** Před instalací a použitím produktu si prosím přečtěte pokyny a záruční podmínky na [www.palmako.ee/information-hub](http://www.palmako.ee/information-hub), abyste zaručili správnou instalaci a dlouhodobý výkon.

**Polski (Przetłumaczone przez AI):** Przed zainstalowaniem i użyciem produktu należy przeczytać instrukcję oraz warunki gwarancji dostępne na stronie [www.palmako.ee/information-hub](http://www.palmako.ee/information-hub), co pozwoli zagwarantować prawidłową instalację i długotrwałą wydajność.

**Latviešu (Mākslīgā intelekta tulkojums):** Pirms produkta uzstādīšanas un lietošanas, lūdzu, izlasiet instrukcijas un garantijas noteikumus vietnē [www.palmako.ee/information-hub](http://www.palmako.ee/information-hub), lai garantētu pareizu uzstādīšanu un ilgstošu darbību.





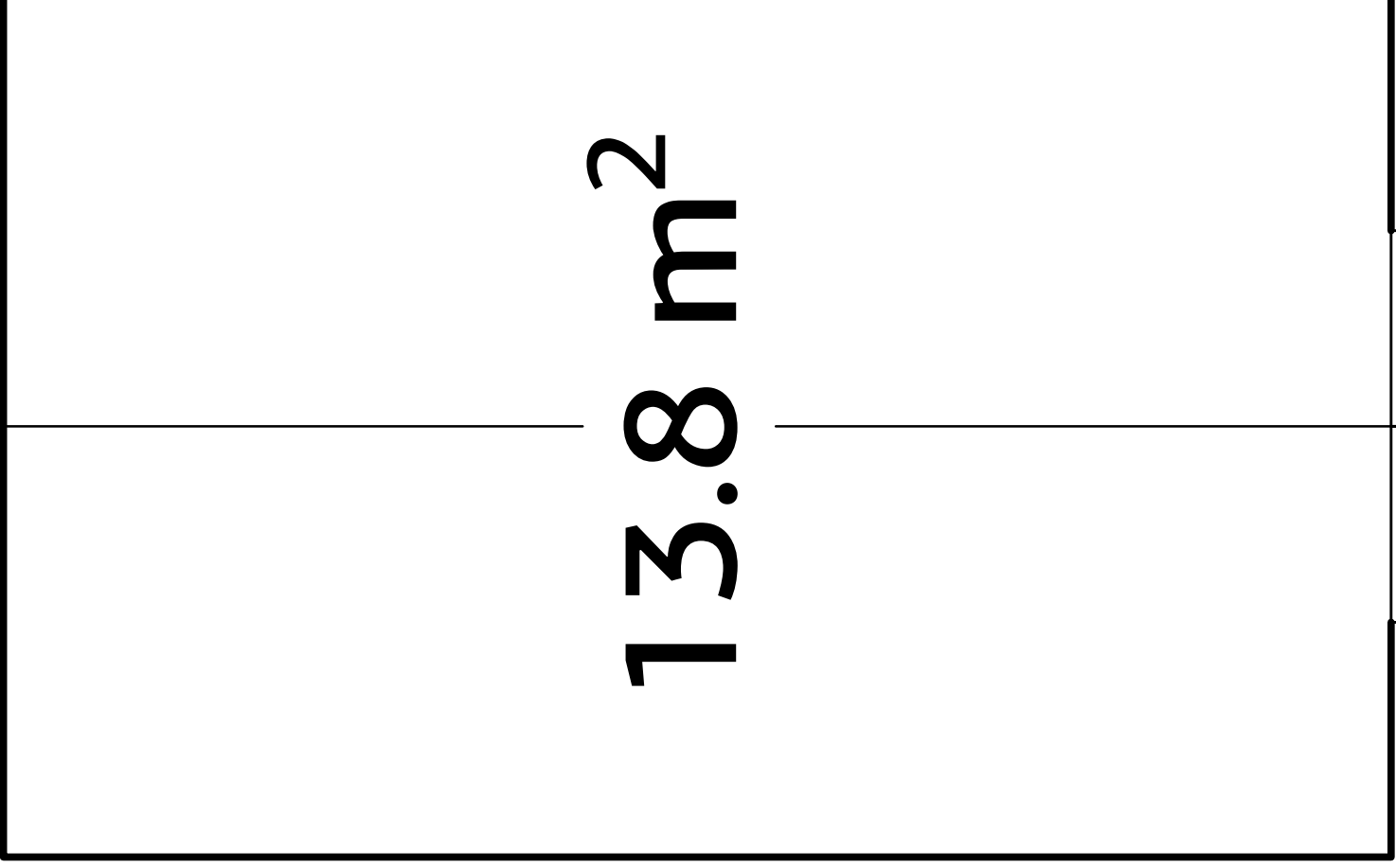







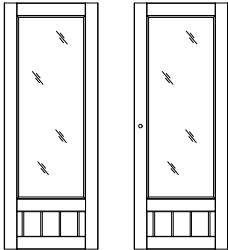
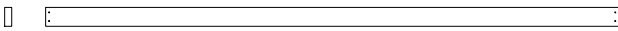
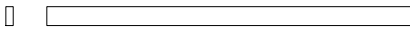

**Lietuviškai (Išvertė DI):** Prieš montuodami ir naudodami gaminį, perskaitykite instrukcijas ir garantijos sąlygas adresu [www.palmako.ee/information-hub](http://www.palmako.ee/information-hub), kad užtikrintumėte tinkamą montavimą ir ilgalaikį veikimą.



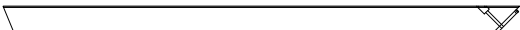
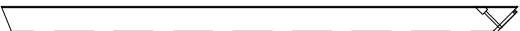
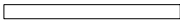

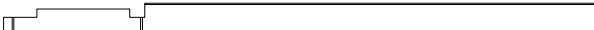
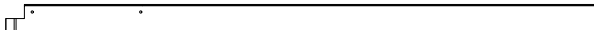

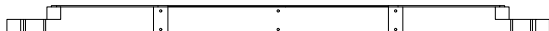
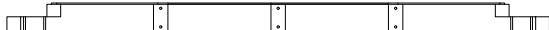

300

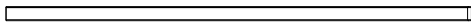
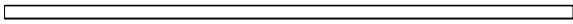

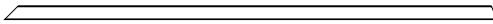
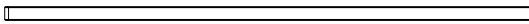
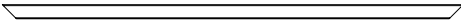
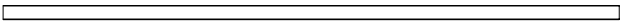
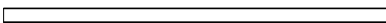
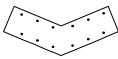
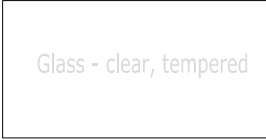



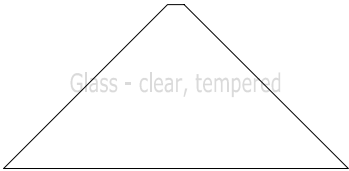



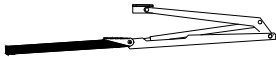

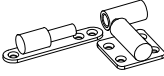
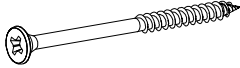
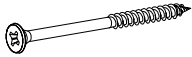



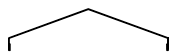
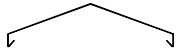

483

13.8 m<sup>2</sup>

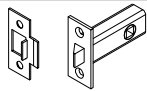
Pos.	Description	Measures (mm)	Pcs
EL1		657 x 390 x 45	2
EL2		2810 x 390 x 45	1
EL3A		2370 x 390 x 45	2
EL3B		2370 x 390 x 45	2
KUL-145 KUL-145-2		696 x 1818 x 40	1+1
1		4828 x 120 x 45	2
2		2910 x 120 x 45	2
3		1502 x 95 x 44	2
4		1502 x 95 x 44	2
5		1562 x 95 x 44	14
6		1879 x 95 x 44	2
7		1879 x 95 x 44	2
8		554 x 45 x 45	4
9		1879 x 95 x 44	14
10		1893 x 95 x 44	3
11		1893 x 95 x 44	1
12		1893 x 95 x 44	1
13		2182 x 95 x 44	1
14		2182 x 95 x 44	1
15		661 x 91 x 44	2
16		4976 x 240 x 80	1

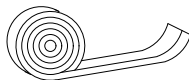
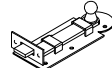
Pos.	Description	Measures (mm)	Pcs
20		1502 x 45 x 12	20
21		1827 x 45 x 12	7
22		1478 x 45 x 12	4
23		1814 x 45 x 12	4
24		1910 x 45 x 12	18
25		1895 x 45 x 12	2
26		2410 x 45 x 12	4
27		1383 x 45 x 12	2
33		360 x 173 x 15	32
101		578 x 1115 x 4	16
102		578 x 1895 x 4	12
103		578 x 1030 x 4	4
104		680 x 1458 x 4	4
105		704 x 1458 x 4	2
106		700 x 1862x 4	2
107		620 x 910 x 4	4

Pos.	Description	Measures (mm)	Pcs
F1	 QThermovent	Thermovent 7kg	4
F2	 QUH55x60	55 x 60	8
F3	 QNU62x40x13	62 x 40 x 13	18
F4	 QHP15x57Zn	15 x 57	4
F5	 QKRPP6x120RVTX	Ø 6 X 120	8
F6	 QKRPP5x90RVTX	Ø 5 X 90	122
F7	 QKRYP5x55RVTX	Ø 5 X 55	410
F8	 QKRYP4_2x38RVTX	Ø 4.2 X 38	330
F9	 QKRPP3_5x40RVTX	Ø 3.5 X 40	12
F10	 QKRPP4x25RVTX	Ø 4 X 25	20
F11	 Polt M6	Ø 6 X 200	9
F12	 QMUUK6Zn	M6	9
F13	 QSE6x18Zn	Ø 6 X 18	18
F14	 YHP200x2488MU	2488 x 200 x 46	2
F15	 YHP201x100MU	100 x 201 x 47	1
F16	 QHA150Zn	150 mm	2
F17	 QUNAL		1set
F18	 QRUAu		1set
F19	 QLIKA		1set
F20	 QTI3x8MU	0.8 m	1
F21	 QR35100Zn	35 x 100	2
F22	 QKRYP3x16Zn	Ø 3 X 16	16

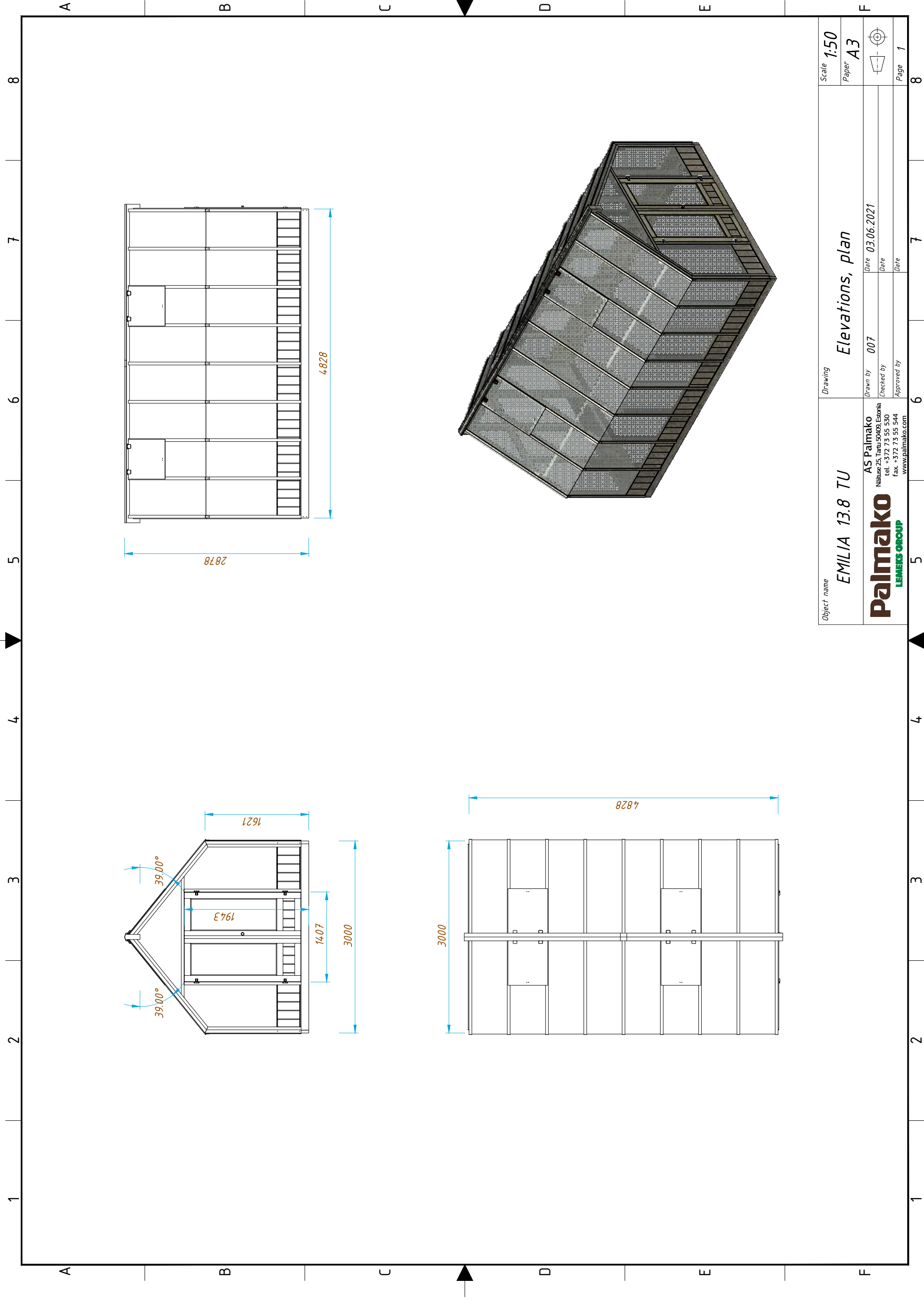

Object name

EMILIA 13.8 TU

**Palmako**  
 LEAMERS GROUP  
 AS Palmako  
 Näituse 25, Tartu, 50409, Estonia  
 tel. +372 73 55 530  
 fax +372 73 55 544  
 www.palmako.com

Drawing

Elevations, plan

Drawn by 007  
 Checked by  
 Approved by  
 Date 03.06.2021  
 Date  
 Date

Scale 1:50

Paper A3



Page 1

det 1 - 2 pcs  
det 2 - 2 pcs  
F5 - 8 pcs

1

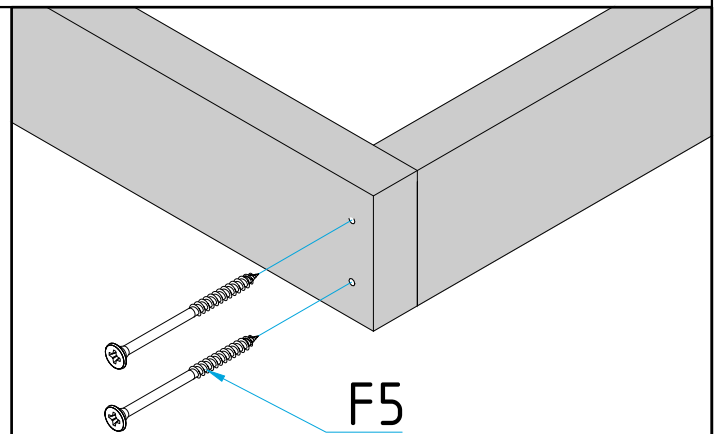
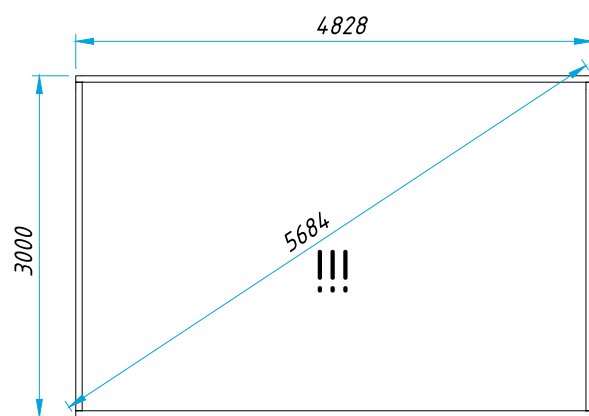
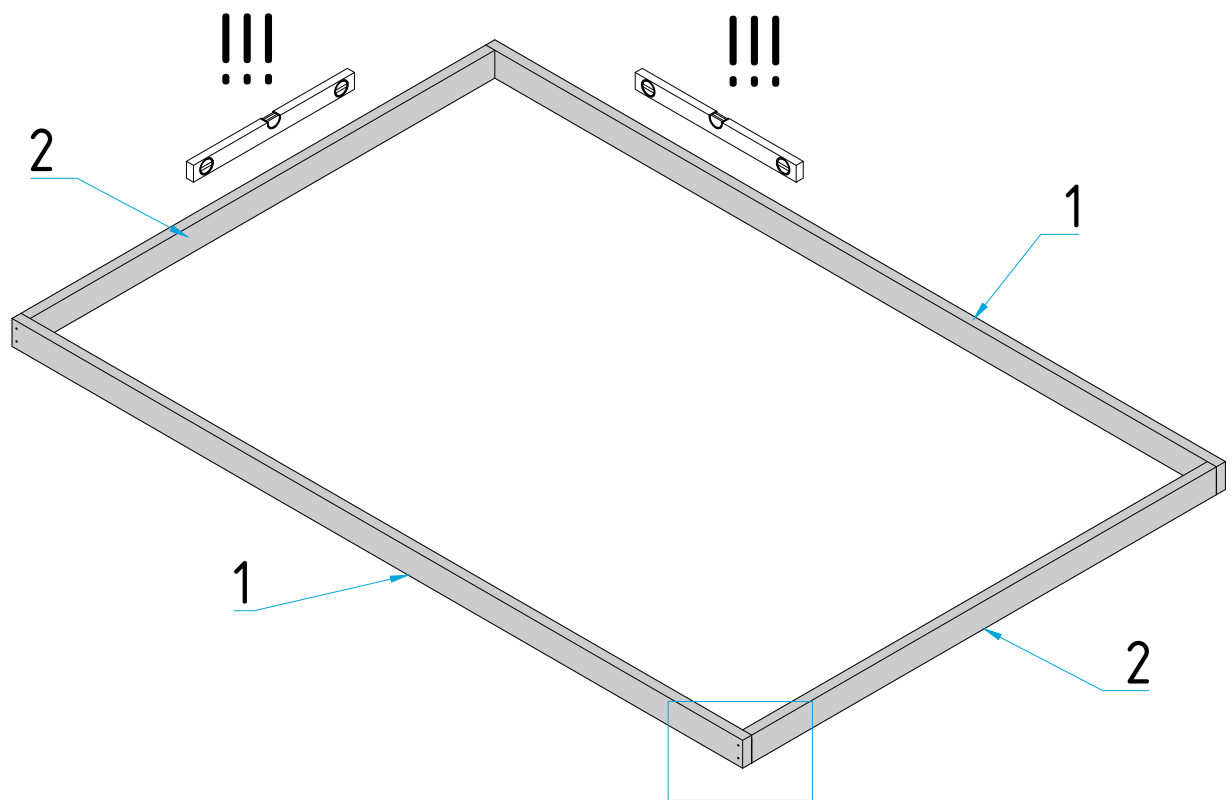

- EL 1 - 2 pcs
- EL 2 - 1 pcs
- EL 3A - 2 pcs
- EL 3B - 2 pcs
- F6 - 26 pcs

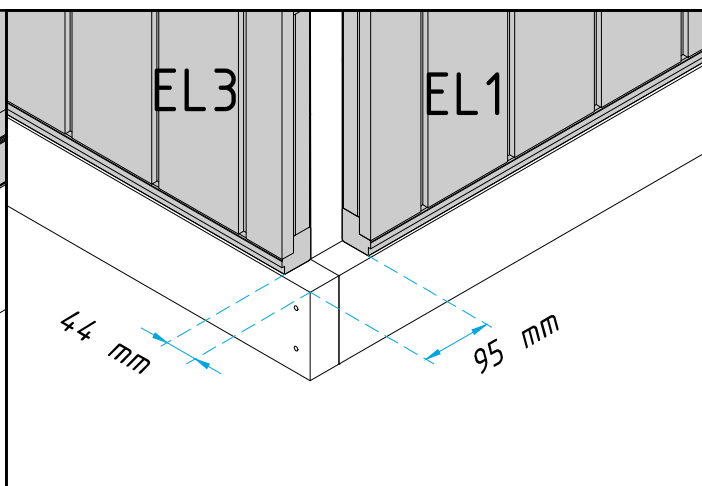
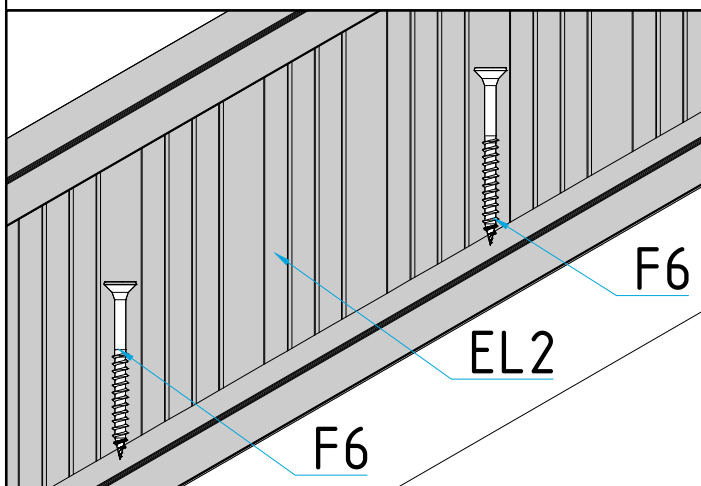
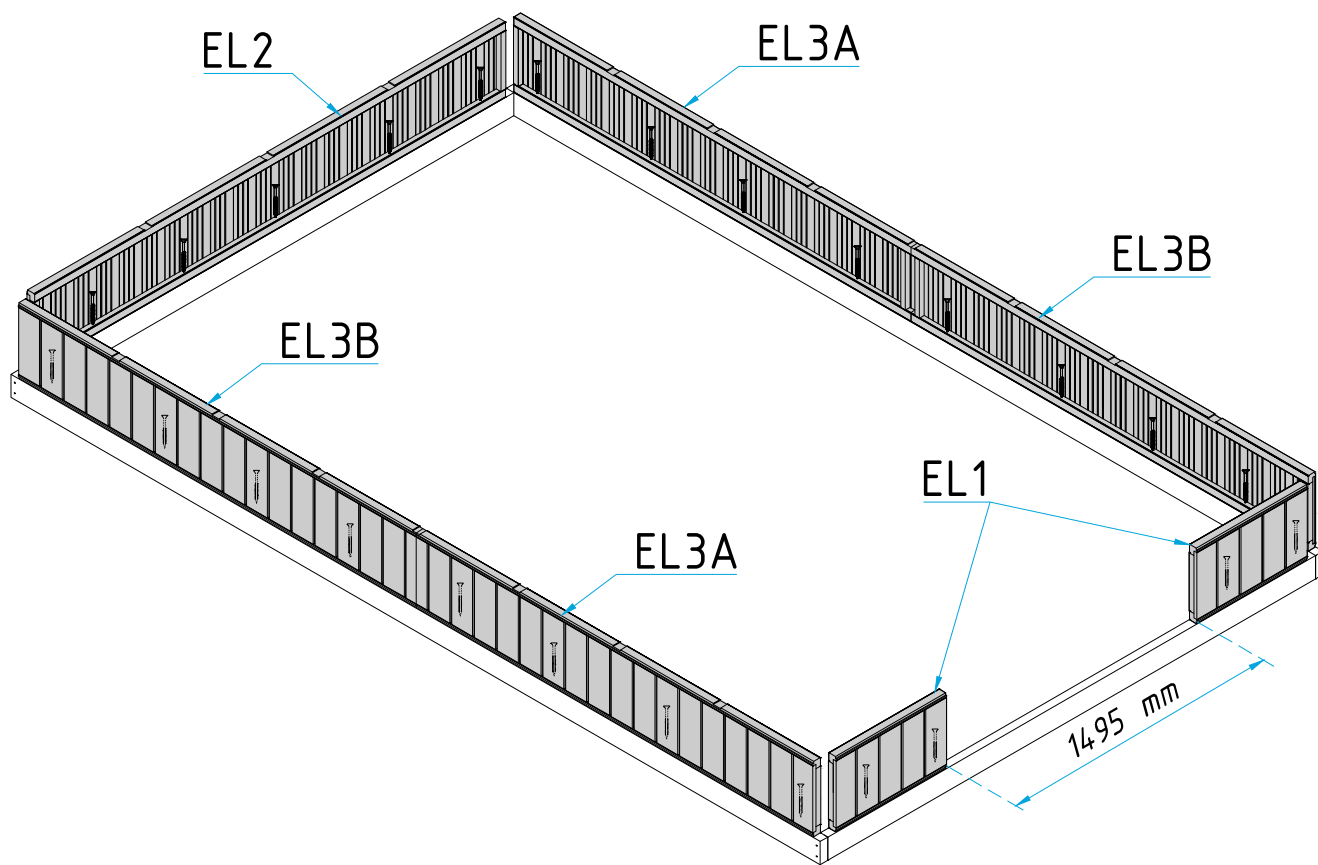

- det 3 - 2 pcs    F6 - 16 pcs
- det 4 - 2 pcs    F7 - 48 pcs
- det 6 - 2 pcs
- det 7 - 2 pcs
- det 33 - 4 pcs

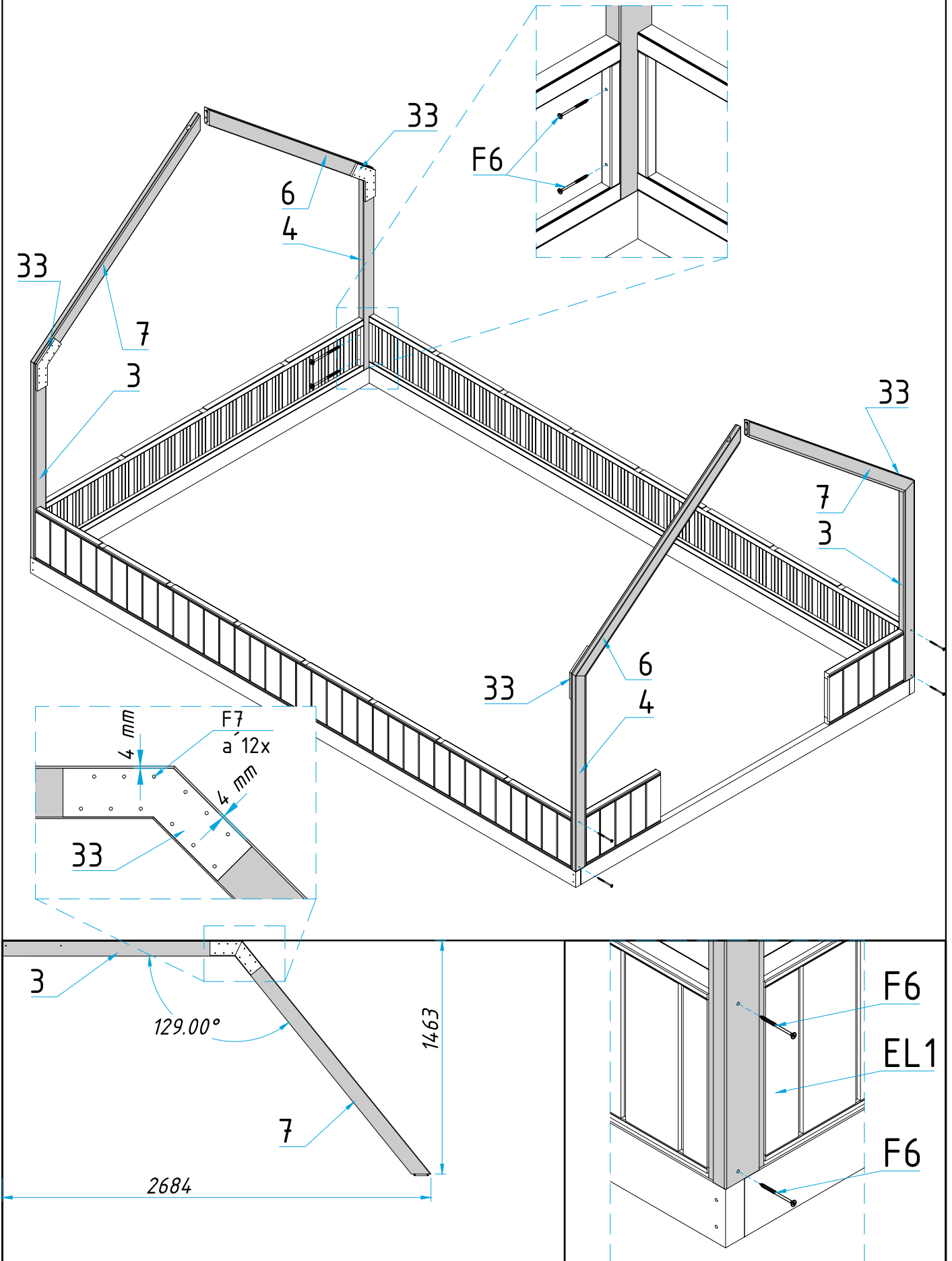

det 16 - 1 pcs

F11 - 2 pcs

F12 - 2 pcs

F13- 4 pcs

4

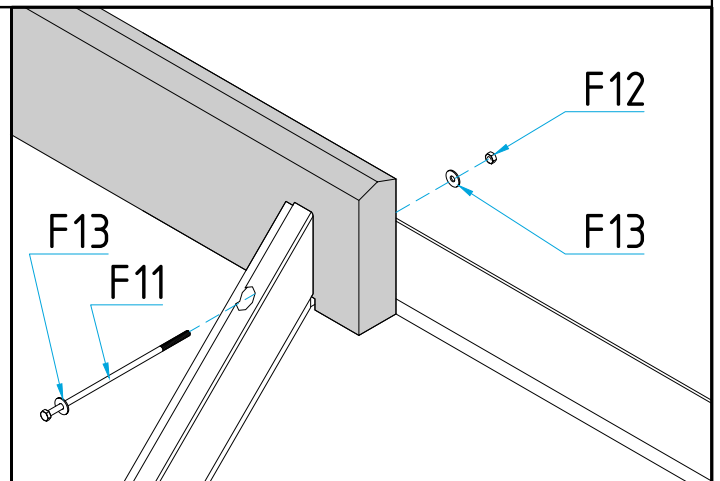
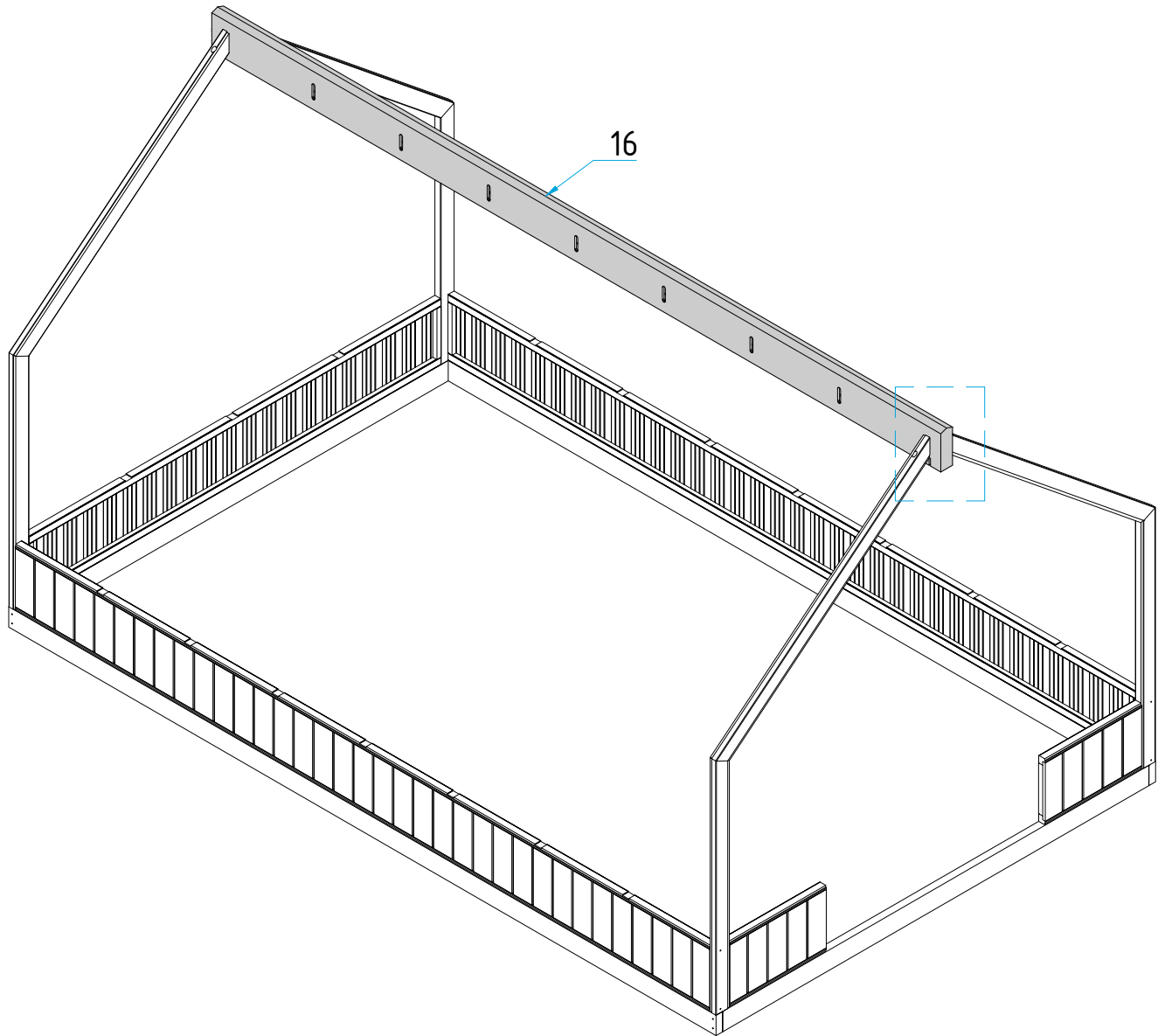

- det 10 - 3 pcs
- det 11 - 1 pcs
- det 12 - 1 pcs
- det 13 - 1 pcs
- det 14 - 1 pcs
- det 15 - 2 pcs

F6 - 34 pcs

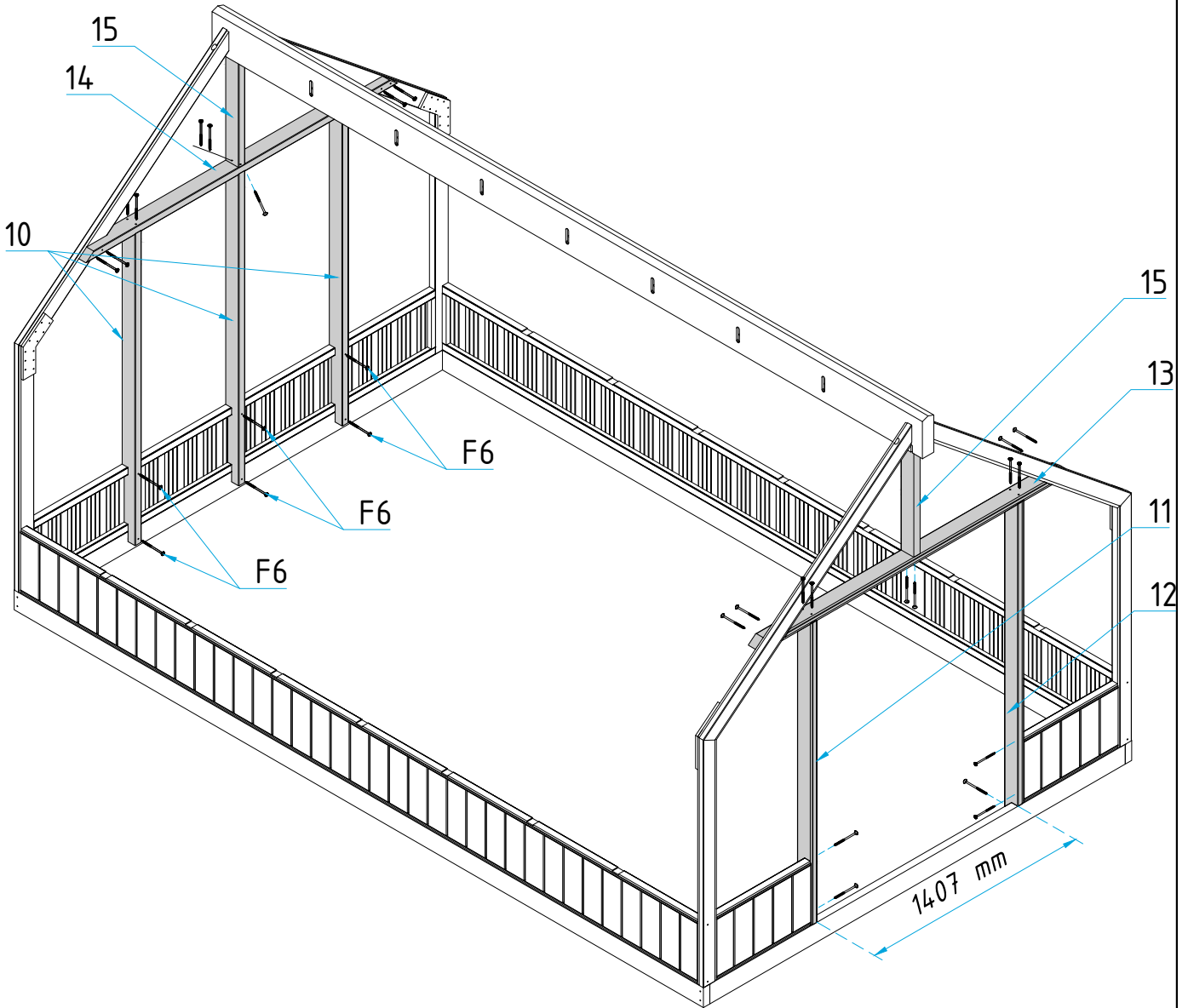

- |                 |             |
|-----------------|-------------|
| det 5 - 14 pcs  | F6 - 42 pcs |
| det 8 - 2 pcs   | F7- 356 pcs |
| det 9 - 14 pcs  | F8- 8 pcs   |
| det 33 - 28 pcs | F11 - 7 pcs |
| det 26 - 4 pcs  | F12 - 7 pcs |
|                 | F13- 14 pcs |

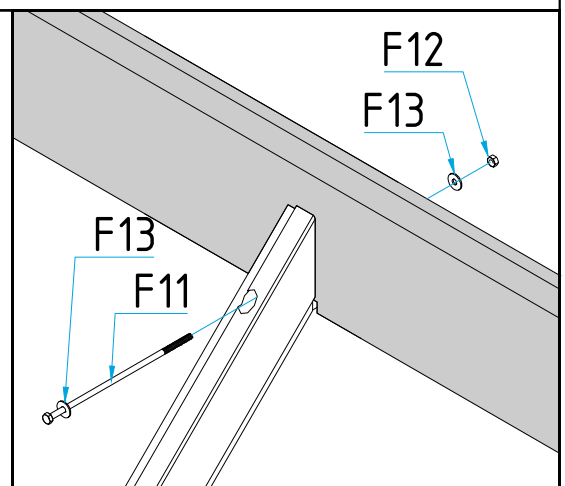
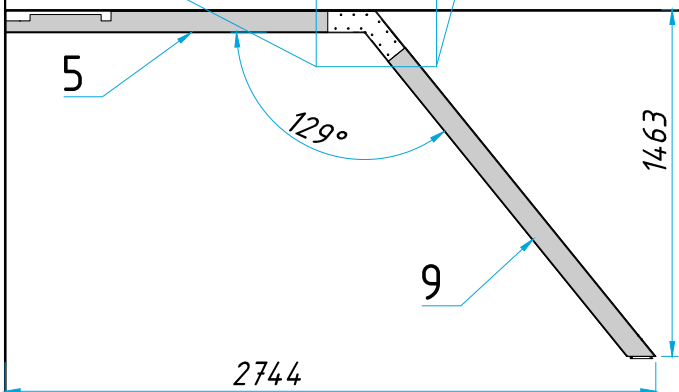
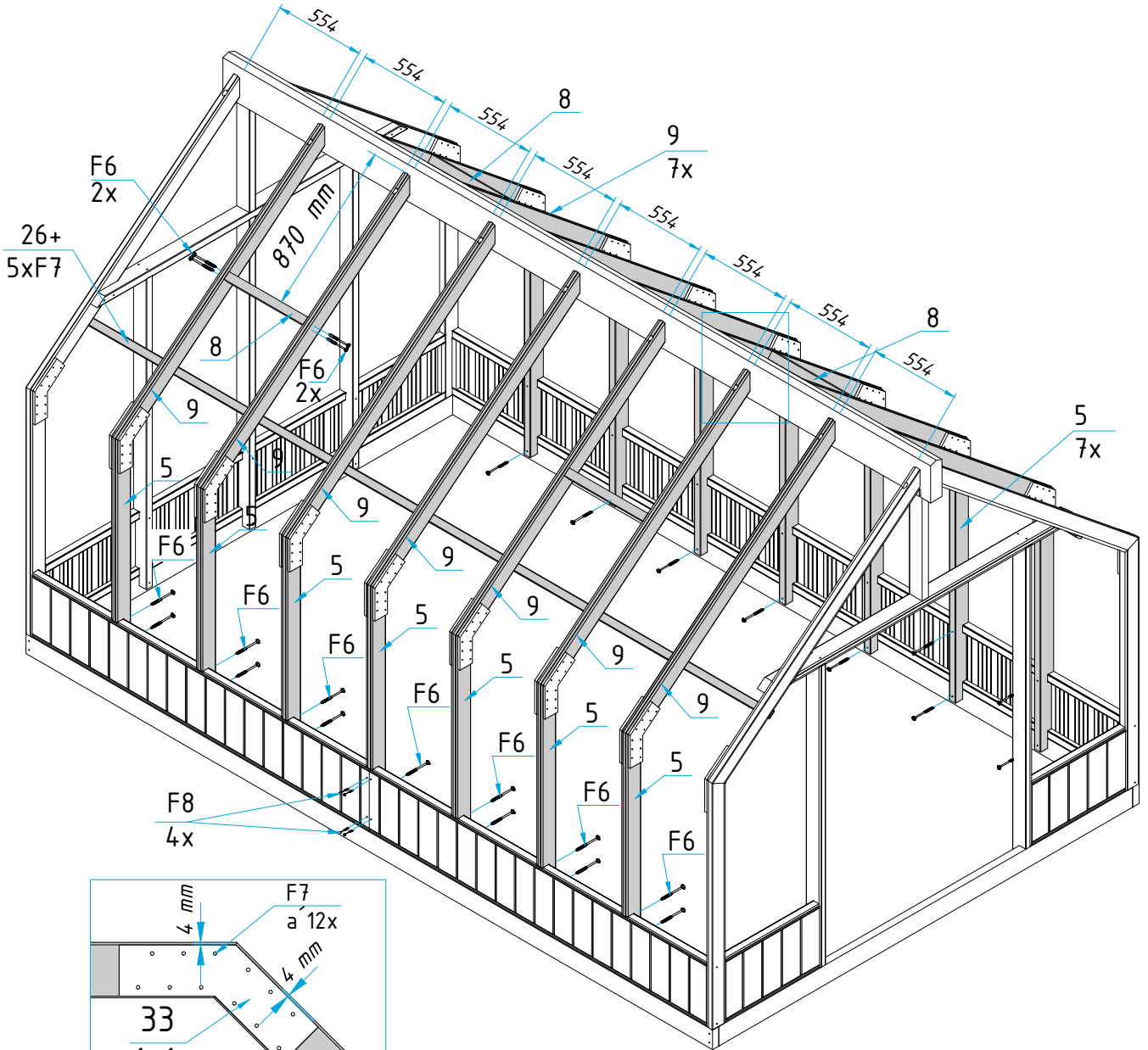

det 101 - 16 pcs

det 20 - 18 pcs

F3 - 18 pcs

F8 - 90 pcs

F20 - 18 pcs 

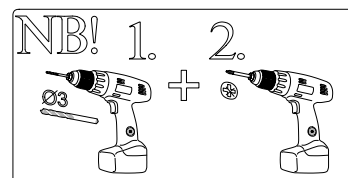

7

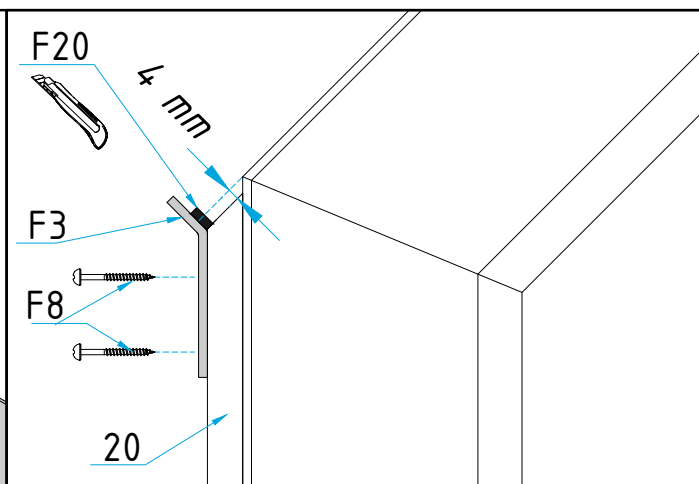
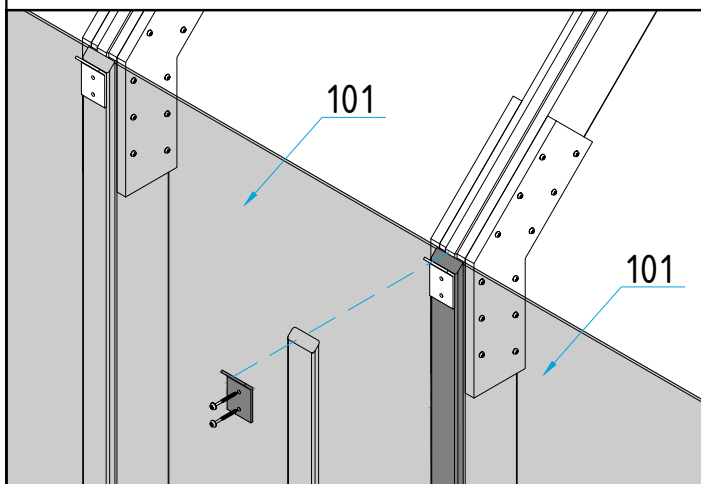
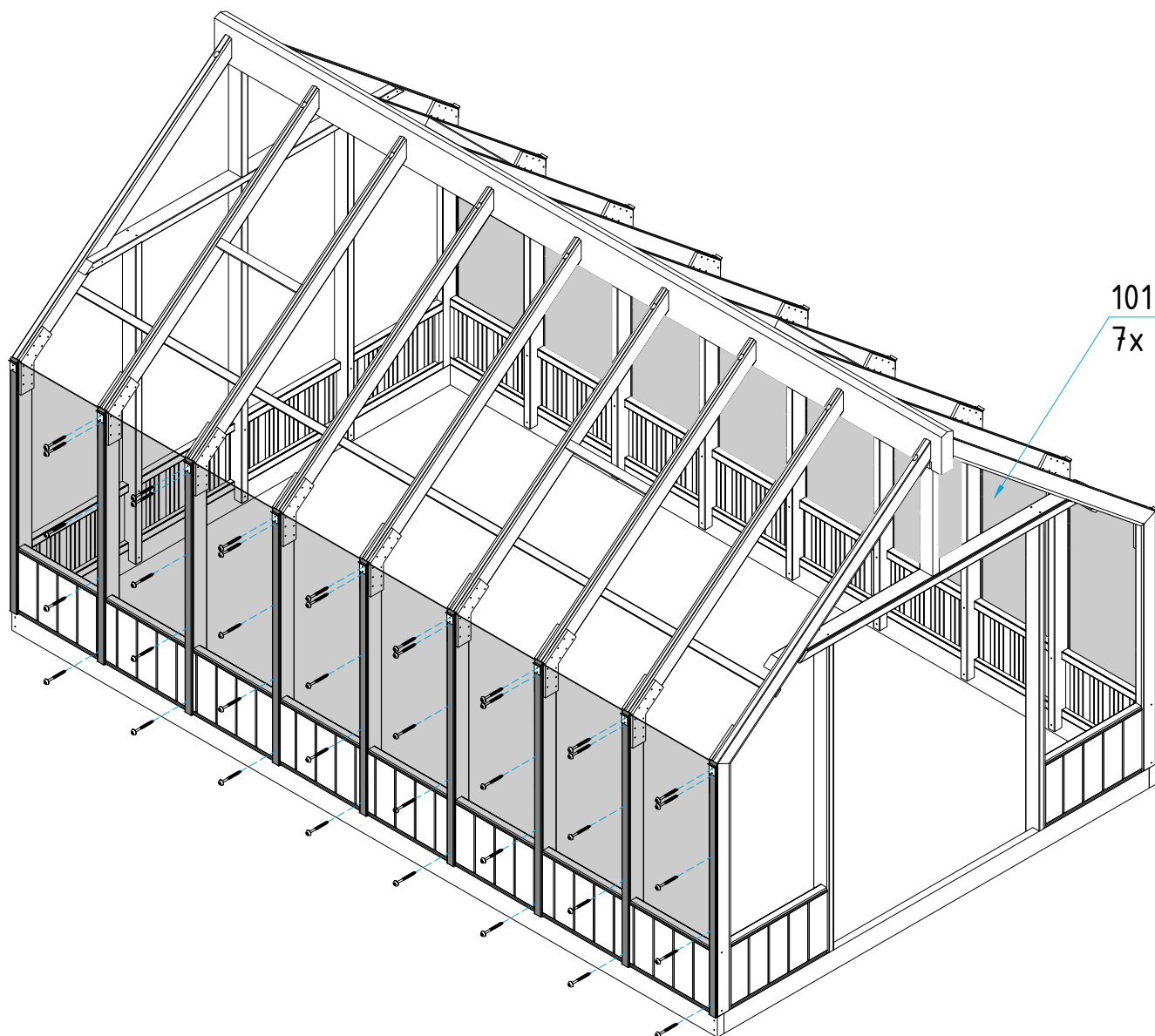

det 102 - 1 pcs  
det 103 - 1 pcs  
det 24 - 3 pcs  
F8 - 15 pcs

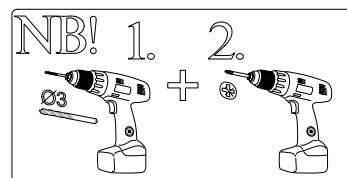

8

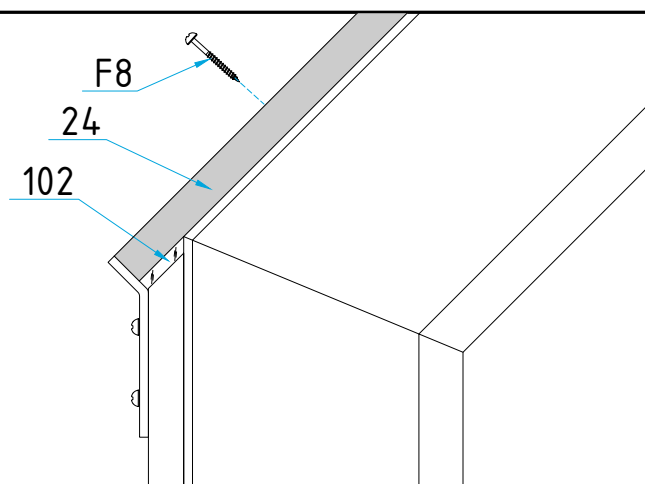
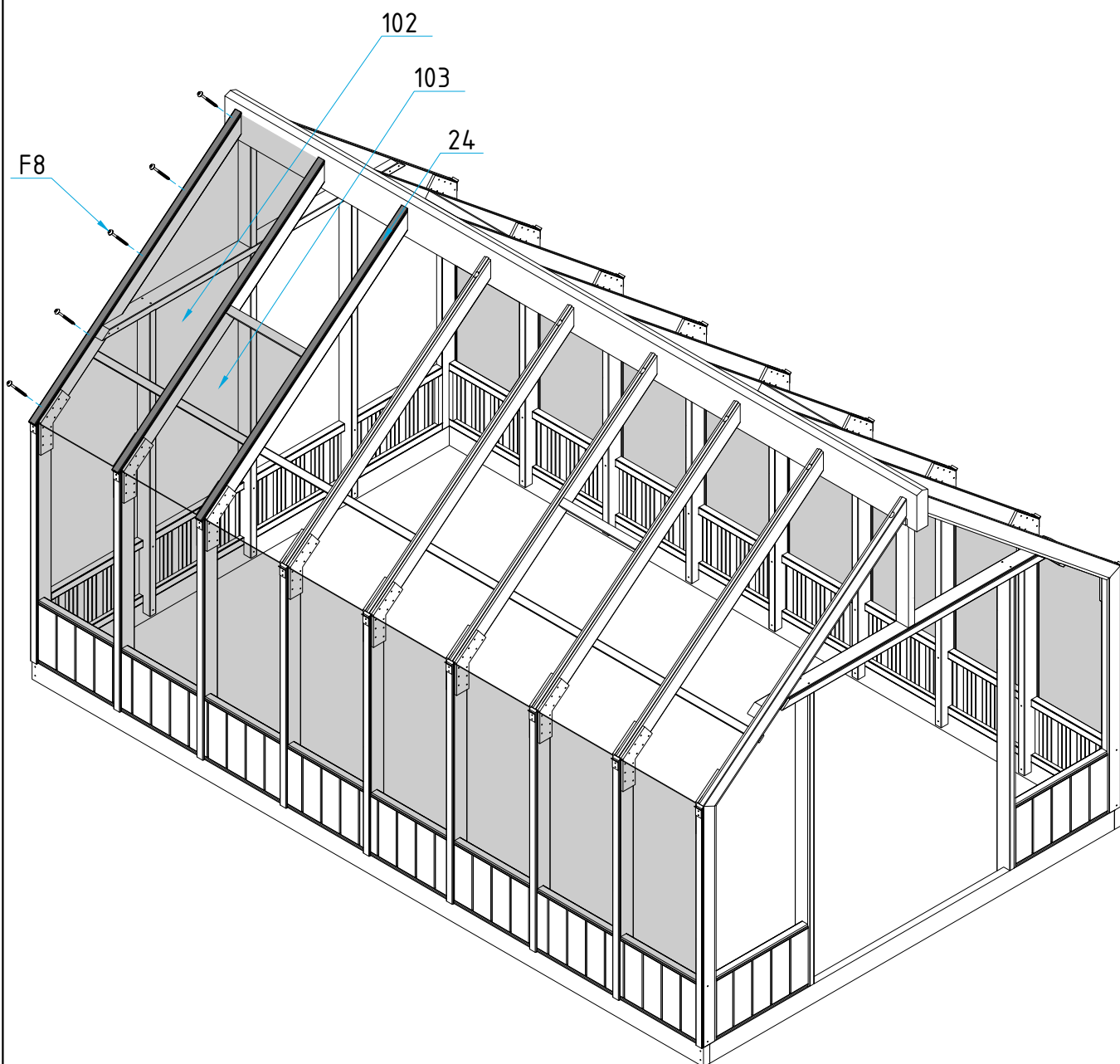

F2

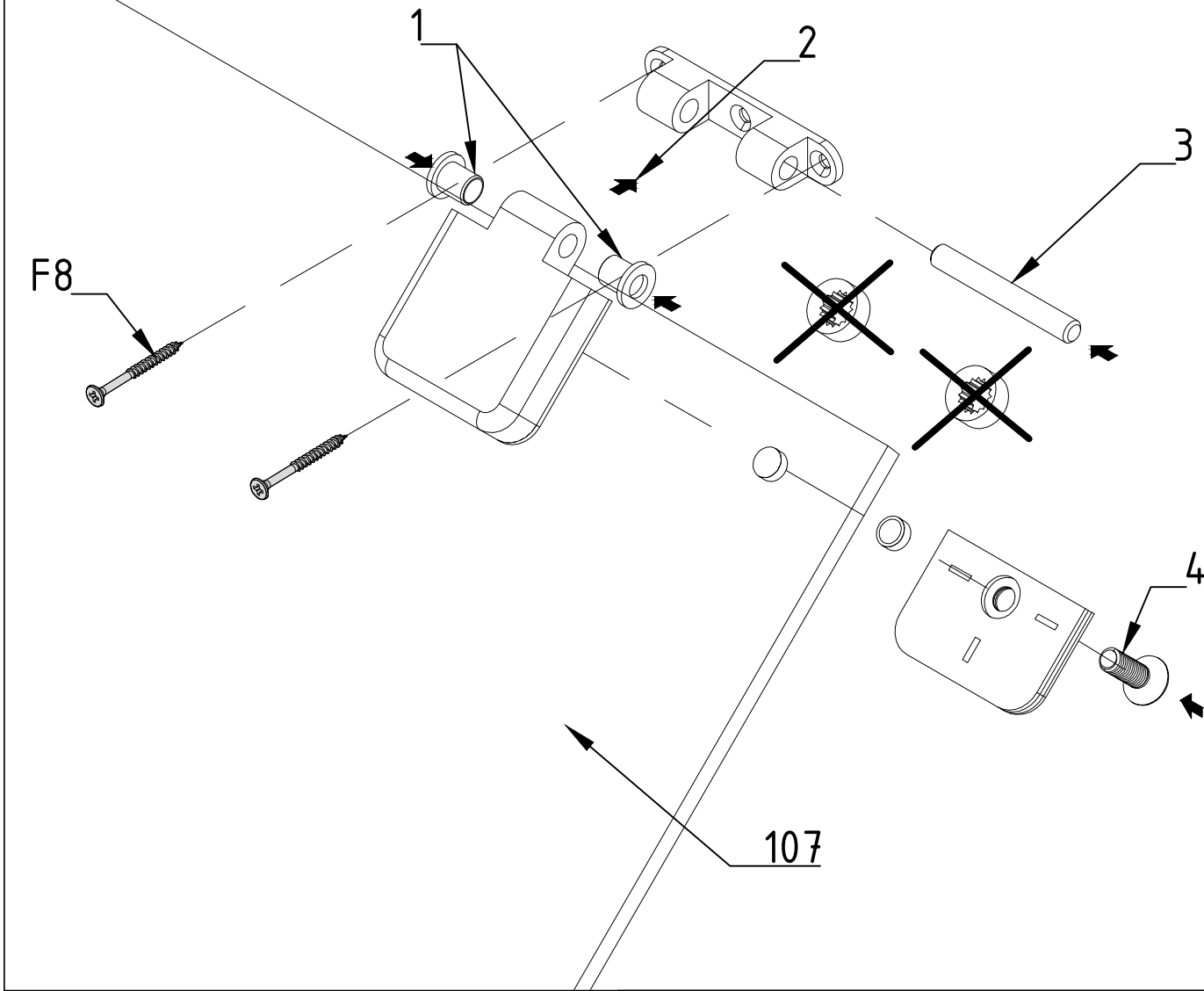

det 107 - 1 pcs

F1 - 1 pcs

F2 - 2 pcs

F8 - 4 pcs

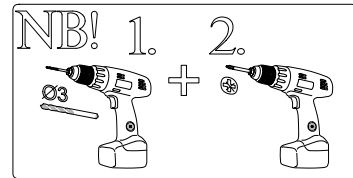

9-2

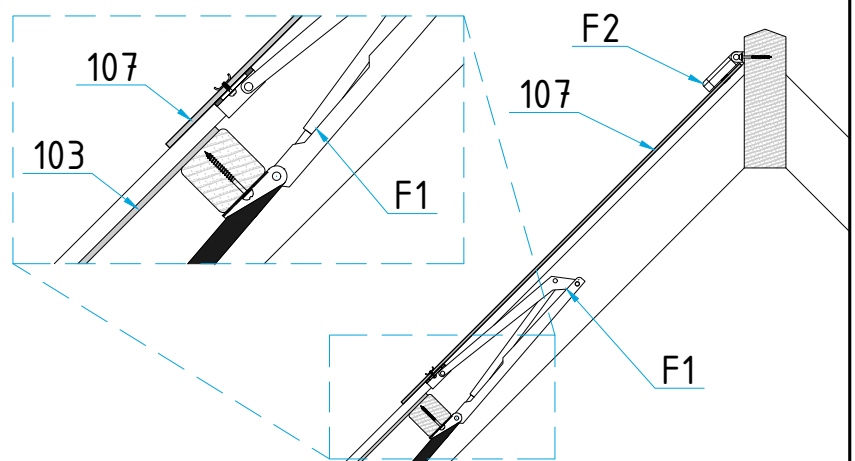
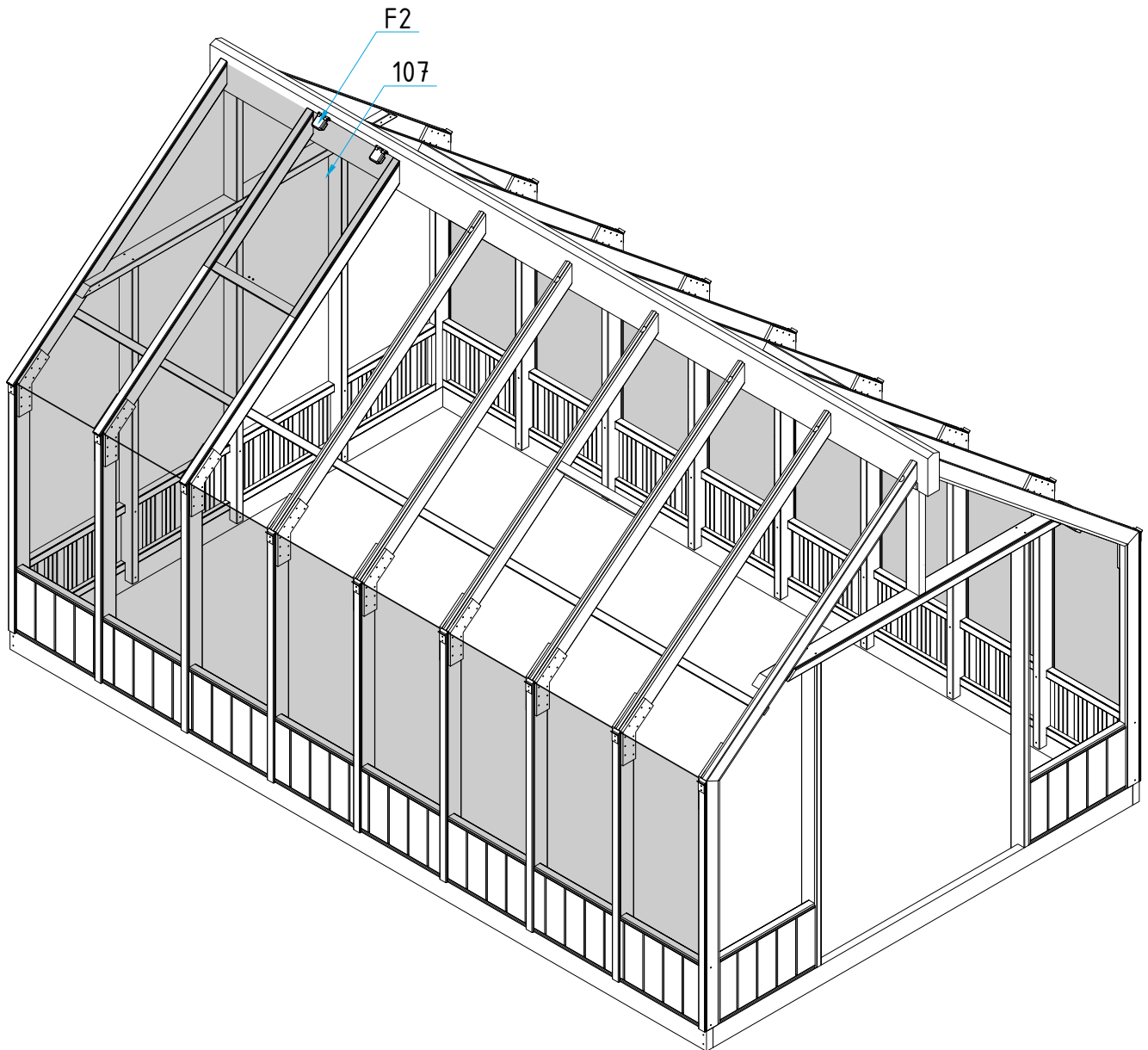

- det 102 - 5 pcs
- det 103 - 1 pcs
- det 107 - 1 pcs
- det 24 - 6 pcs
- F1 - 1 pcs
- F2 - 2 pcs
- F8 - 34 pcs

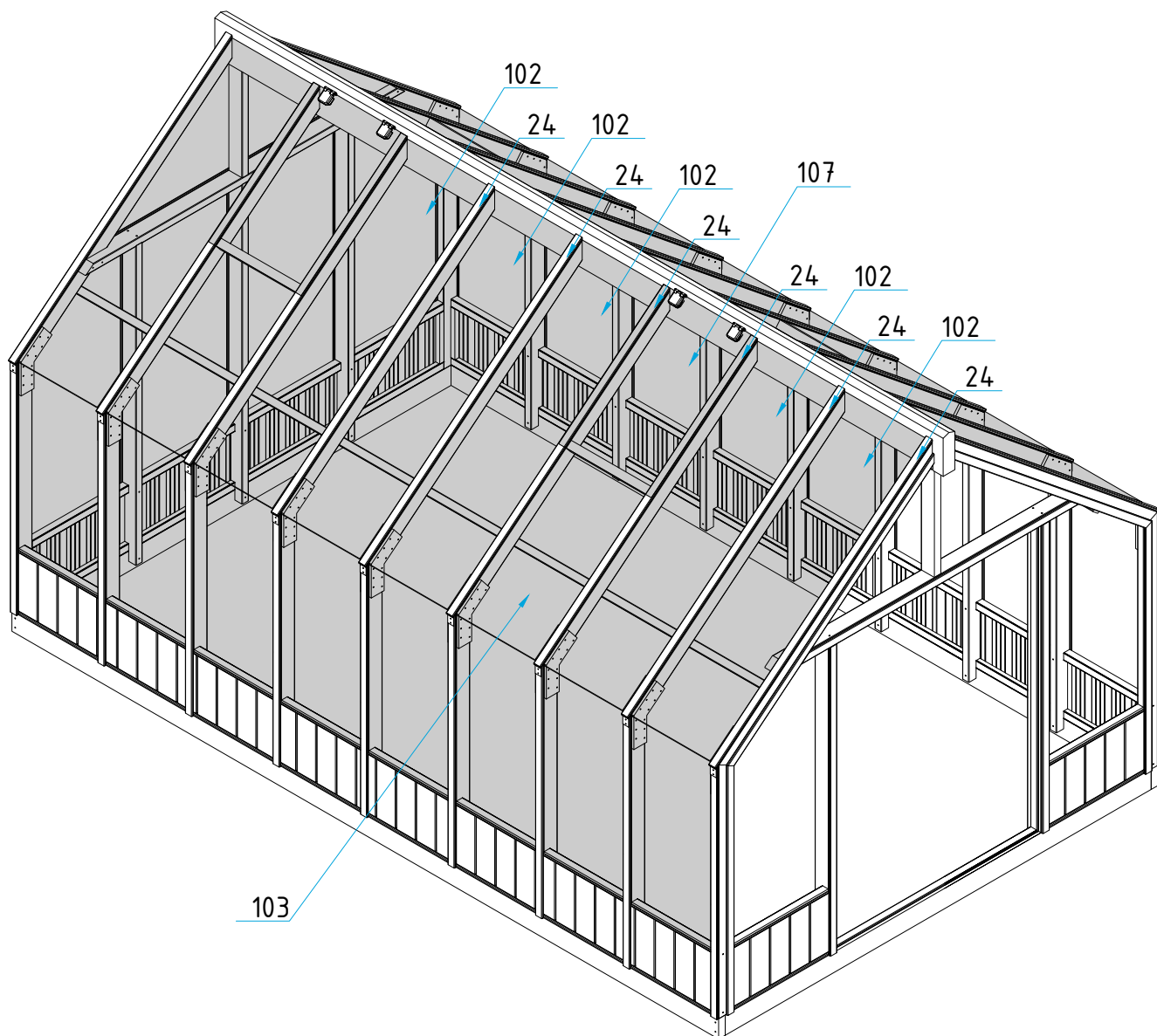
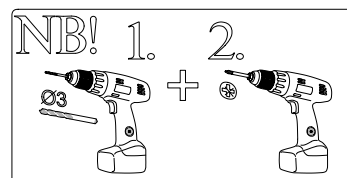



det 104 - 2 pcs  
det 105 - 2 pcs  
det 106 - 1 pcs  
det 21 - 3 pcs  
det 22 - 2 pcs  
det 23 - 2 pcs  
det 25 - 1 pcs

F8 - 40 pcs

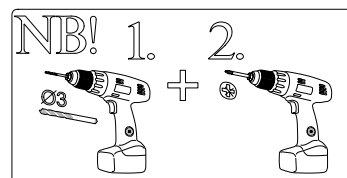

12

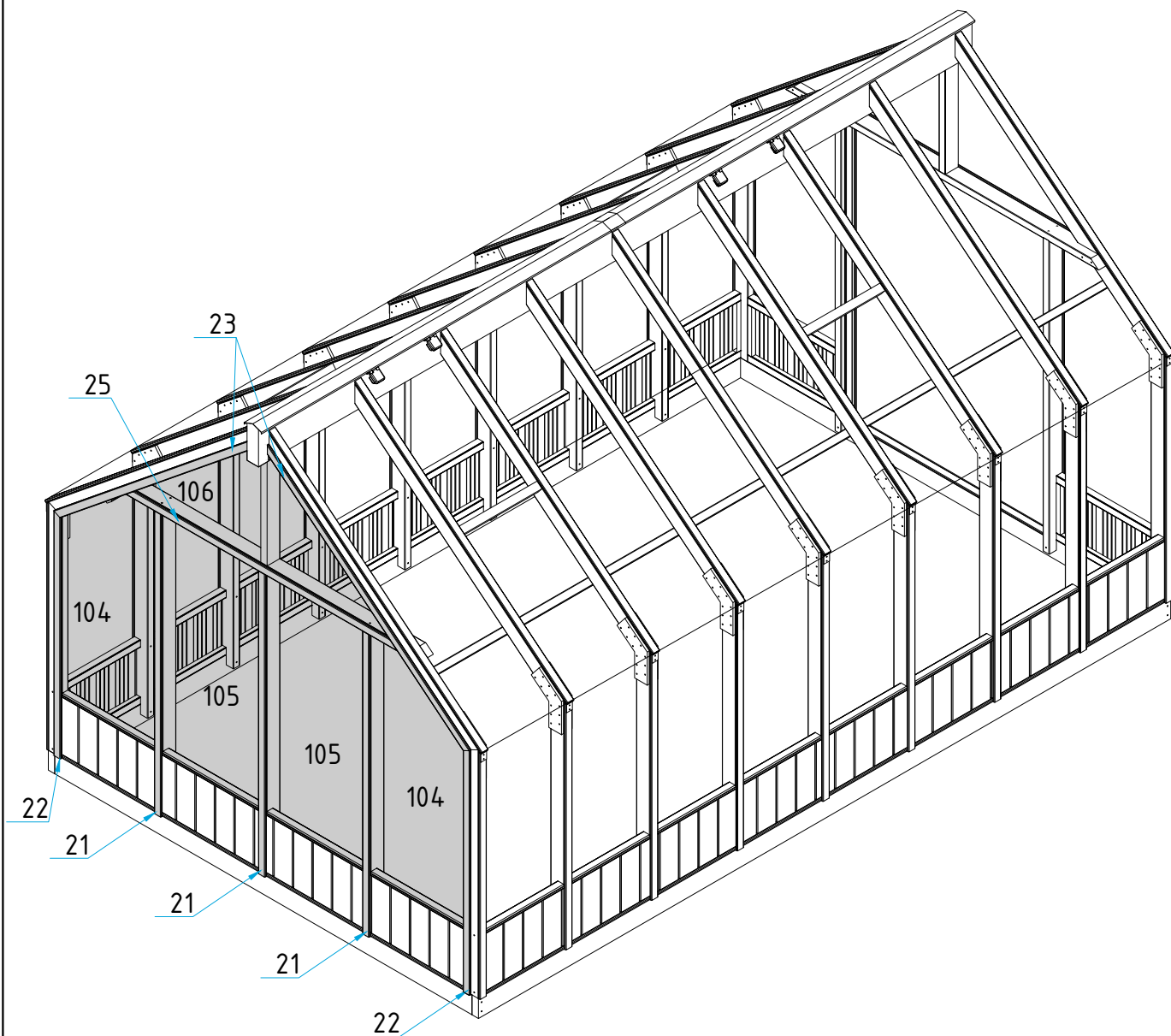

det 104 - 2 pcs  
det 106 - 1 pcs  
det 21 - 4 pcs  
det 22 - 2 pcs  
det 23 - 2 pcs  
det 25 - 1 pcs  
det 27 - 2 pcs

F8 - 55 pcs

13

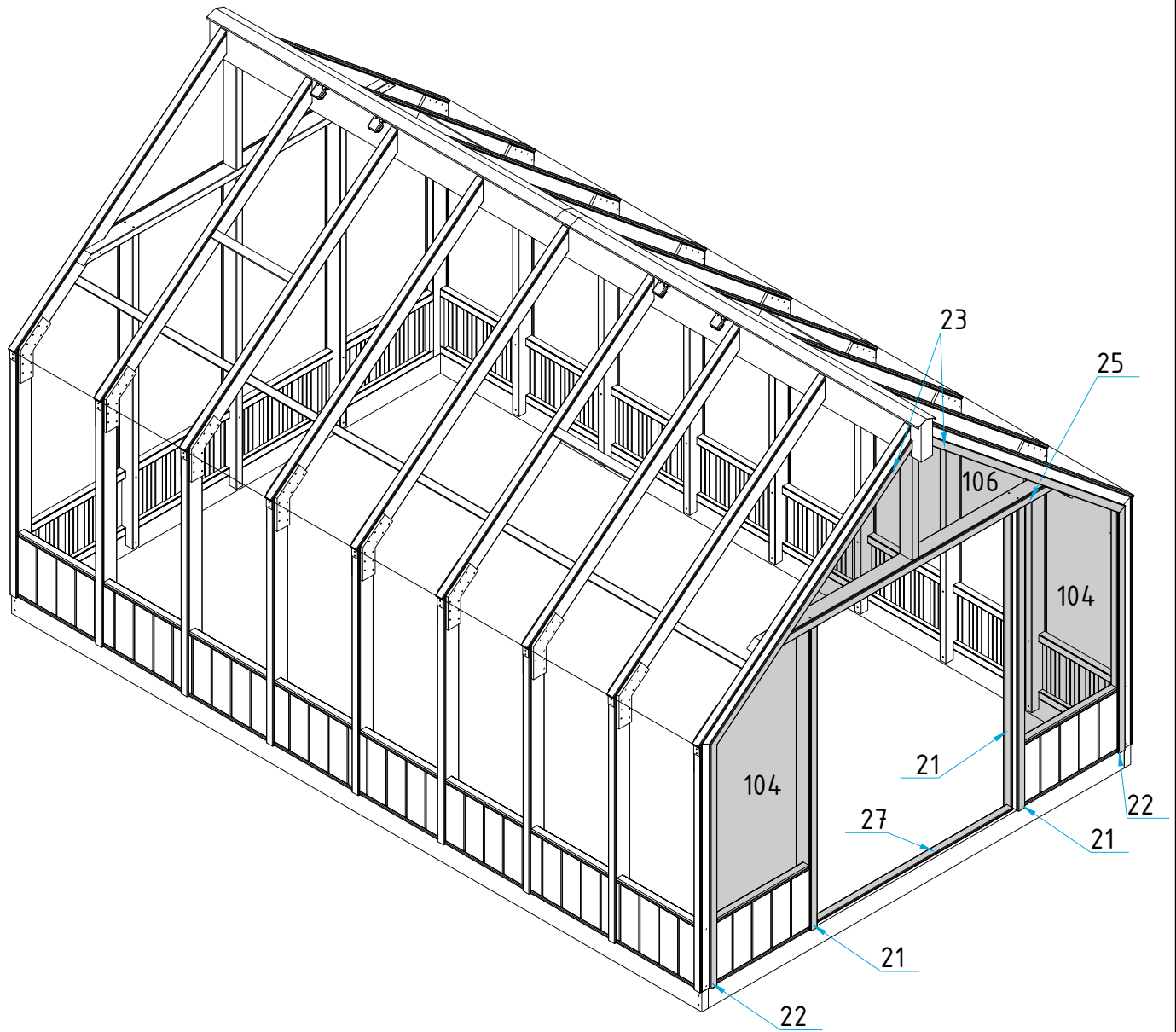

KUL-145 - 1 pcs  
KUL-145 - 2 pcs

F4 - 4 pcs  
F9 - 12 pcs  
F10 - 20 pcs  
F16 - 1 pcs  
F17 - 1 pcs  
F18 - 1 pcs  
F19 - 1 pcs  
F21 - 2 pcs  
F22 - 16 pcs

