

Assembly, installation and maintenance manual

Montage-, Aufbau- und Wartungsanleitung • Assemblage, manuel de montage et d'entretien • Montaje, instalación y mantenimiento • Manuale di montaggio, installazione e manutenzione • Monterings- og vedlikeholdsmanual • Monterings-, installations- och underhållsmanual • Kokoamis-, asennus- ja huolto-ohje • Vejledning for montering og vedligehold • Handleiding voor montage, installatie en onderhoud • Manual de montagem, instalação e manutenção • Návod k montáži, instalaci a údržbě • Instrukcja montażu, instalacji i konserwacji • Surinkimo, montavimo ir priežiūros vadovas • Montāžas, uzstādīšanas un apkopes rokasgrāmata • Руководство по сборке и обслуживанию • Montaaži-, paigaldus- ja säilitamise juhend



Element house **EL18-9034-2**

<p>Factory inspection by • Werkskontrolle durch • Contrôle à partir de l'usine par • Inspector de fábrica • Collaudato da • Fabrikkontroll utført av • Fabriksbesiktigat av • Tehtaan tarkastaja • Fabriks Kontrol udført af • Fabrikscontrole door • Inspeção de fábrica, por: • Zkontrolováno ve výrobním závodě • Kontrola fabryczna do • Apžiūrą gamykloje atliko • Rūpnīcas pārbaudi veicis • Заводской контроль • Tehase kontroll teostatud:</p> <p>.....</p>	<p>Date • Datum • Date • Fecha • Data • Dato • Datum • Päiväys • Dato • Datum • Data • Datum • Data • Datums • Data • Дата • Kuupäev:</p> <hr/> <p>Pack number • Pack Nr. • Packet n° • Bulto N° • Pacco N. • Serienr • Produktionsnummer • Pakettinro • Pakke nr. • Pak nr. • Número de embalagem • Číslo balení • Numer opakowania • Pakuotės numeris • Iepakojuma numurs • Упаковочный номер • Pakinumber:</p>
--	---



www.palmako.ee/information-hub

English: Before installing and using the product, please read the instructions and warranty terms at www.palmako.ee/information-hub to guarantee proper installation and long-lasting performance.

Deutsch: Wichtig! Bitte vor Aufbau und Nutzung des Produkts unbedingt die detaillierte Montageanleitung sowie die Garantiebedingungen unter www.palmako.ee/information-hub lesen, um eine fachgerechte Montage und eine lange Funktionssicherheit zu gewährleisten.

Français: Avant d'installer et d'utiliser le produit, veuillez lire les instructions et les conditions de garantie sur www.palmako.ee/information-hub afin de garantir une installation correcte et la longévité du produit.

Español: Antes de instalar y utilizar el producto, lea las instrucciones y las condiciones de garantía en www.palmako.ee/information-hub para asegurar una instalación correcta y una larga vida útil del producto.

Italiano: Prima di installare e utilizzare il prodotto, leggere le istruzioni e le condizioni di garanzia su www.palmako.ee/information-hub per garantire una corretta installazione e prestazioni durature.

Norsk: Før montering og bruk av produktet, vennligst les monteringsanvisningene og garantivilkårene på www.palmako.ee/information-hub for å sikre korrekt montering og fremtidig holdbarhet.

Svenska: Innan du installerar och använder produkten, vänligen läs instruktionerna och garantivillkoren på www.palmako.ee/information-hub för att säkerställa korrekt installation och produktens långvariga hållbarhet

Suomi: Ennen tuotteen asentamista ja käyttämistä, lue ohjeet ja takuehdot osoitteessa www.palmako.ee/information-hub varmistaaksesi oikean asennuksen ja pitkäkestoisen toiminnan.

Русский: Перед установкой и использованием изделия ознакомьтесь с инструкцией и условиями гарантии на сайте www.palmako.ee/information-hub, чтобы гарантировать правильную установку и долговечность изделия.

Eesti: Enne toote paigaldamist ja kasutuselevõttu lugege palun juhiseid ja garantiitingimusi aadressil www.palmako.ee/information-hub, et tagada nõuetekohane paigaldus ja toote pikk eluiga.

Dansk (Oversat af AI): Læs venligst instruktionerne og garantibetingelserne på www.palmako.ee/information-hub, før du installerer og bruger produktet, for at garantere korrekt installation og langvarig ydeevne.

Dutch (Vertaald door AI): Lees vóór de installatie en het gebruik van het product de instructies en garantievoorwaarden op www.palmako.ee/information-hub om een correcte installatie en langdurige werking te garanderen

Português (Traduzido por IA): Antes de instalar e utilizar o produto, leia as instruções e os termos de garantia em www.palmako.ee/information-hub para garantir uma instalação adequada e um desempenho duradouro.

Čeština (Přeloženo umělou inteligencí): Před instalací a použitím produktu si prosím přečtěte pokyny a záruční podmínky na www.palmako.ee/information-hub, abyste zaručili správnou instalaci a dlouhodobý výkon.

Polski (Przetłumaczone przez AI): Przed zainstalowaniem i użyciem produktu należy przeczytać instrukcję oraz warunki gwarancji dostępne na stronie www.palmako.ee/information-hub, co pozwoli zagwarantować prawidłową instalację i długotrwałą wydajność.

Latviešu (Mākslīgā intelekta tulkojums): Pirms produkta uzstādīšanas un lietošanas, lūdzu, izlasiet instrukcijas un garantijas noteikumus vietnē www.palmako.ee/information-hub, lai garantētu pareizu uzstādīšanu un ilgstošu darbību.

Lietuviškai (Išvertė DI): Prieš montuodami ir naudodami gaminį, perskaitykite instrukcijas ir garantijos sąlygas adresu www.palmako.ee/information-hub, kad užtikrintumėte tinkamą montavimą ir ilgalaikį veikimą.

901

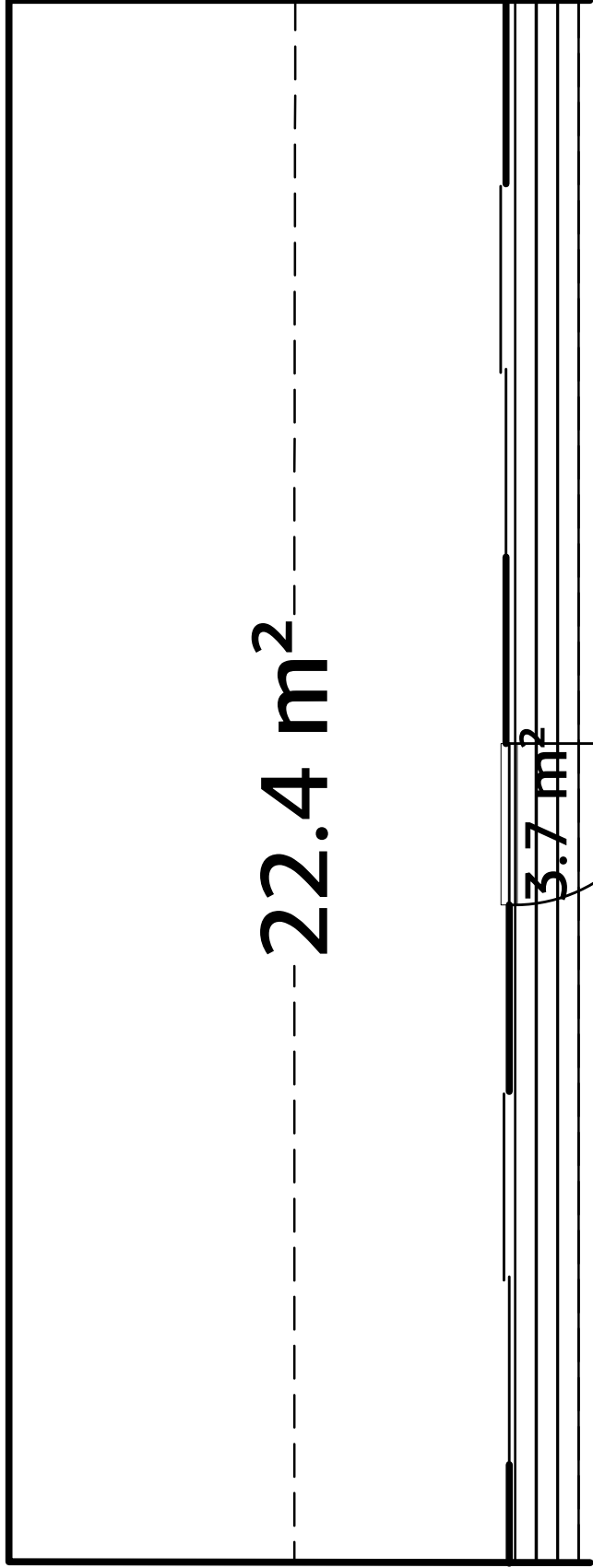

339





289

22.4 m²

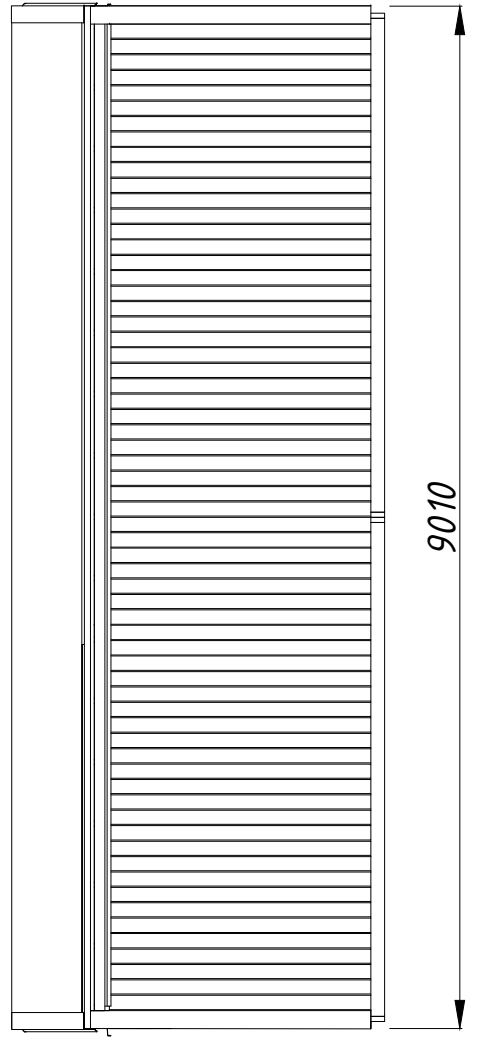
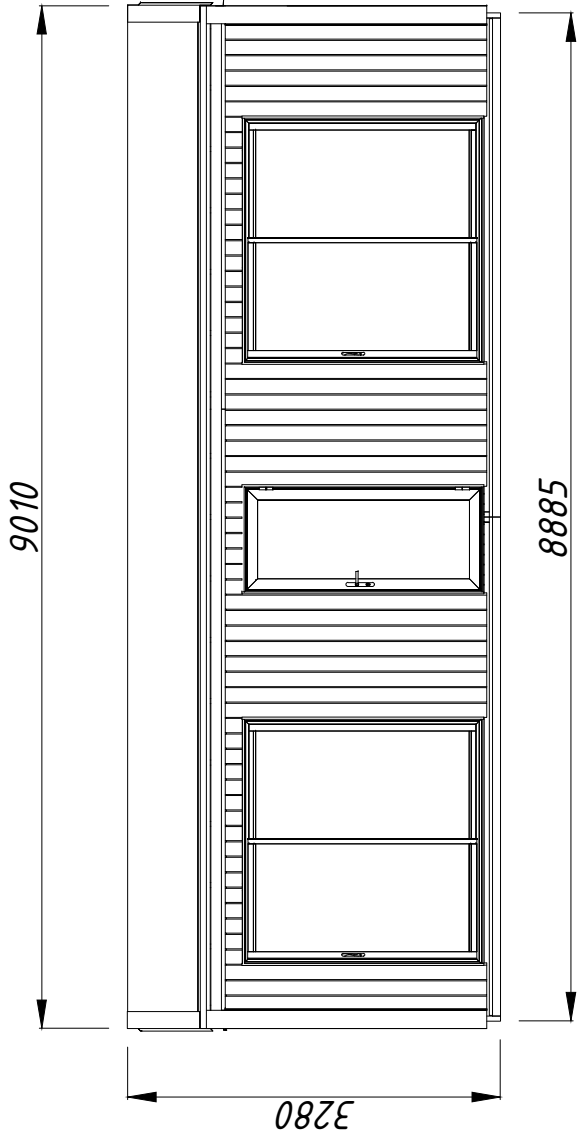
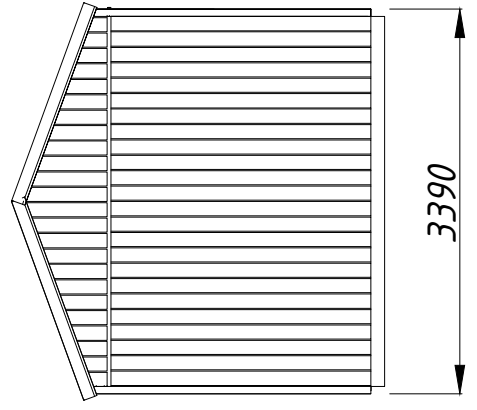
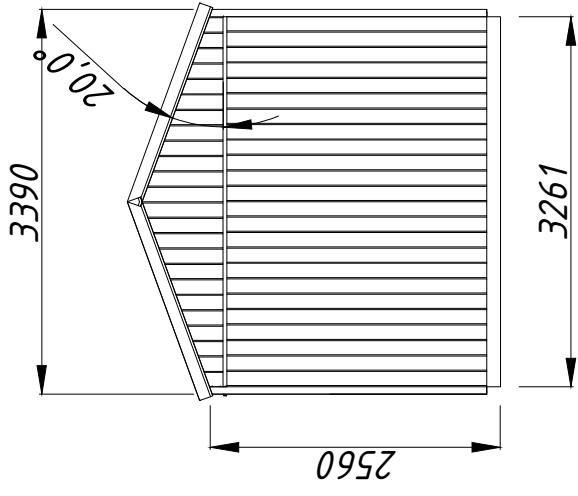

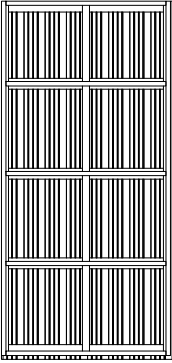
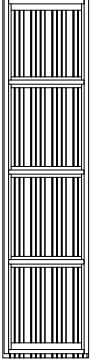
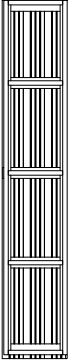

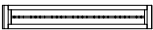



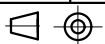

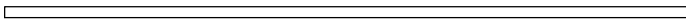
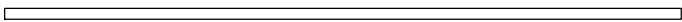





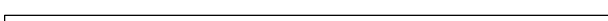







3.7 m²

901











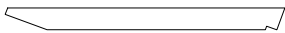

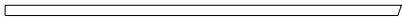

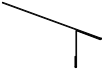

Pos	SPECIFICATION-STÜCKLISTE-NOMENCLATURE-ELEMENTI-ESPECIFICACIÓN EL18-5634-1-1	Pcs	Profile (mm)	Length (mm)
EL1		10	1087X160	2280
EL2		1	543X160	2280
EL3		2	407X160	2280
EL4		1	150X160	2175
EL5		1	150X160	950
EL-Door		1	137X160	2280

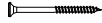

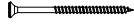
Pos	SPECIFICATION-STÜCKLISTE-NOMENCLATURE-ELEMENTI-ESPECIFICACIÓN EL18-9034-1-2	Pcs	Profile (mm)	Length (mm)
AR1	Foundation- Fundament- Fondation- Fondazione- Vigas de cimentación 	4	45x70	4397
AR2	Foundation- Fundament- Fondation- Fondazione- Vigas de cimentación 	16	45x145	4352
AR3	Foundation- Fundament- Fondation- Fondazione- Vigas de cimentación 	2	45x145	3261
AR4	Foundation- Fundament- Fondation- Fondazione- Vigas de cimentación 	20	45x70	406
AR5	Foundation- Fundament- Fondation- Fondazione- Vigas de cimentación 	2	45x145	2765
BM1	Beam- Balken- Poutre- Trave- Viga 	1	44x140	4695
BM2	Beam- Balken- Poutre- Trave- Viga 	1	44x140	4800
Sla1	Slat- Leiste- Baguette- Listello- Listón 	2	45x45	3895
Sla2	Slat- Leiste- Baguette- Listello- Listón 	2	45x45	4800
Sla3	Slat- Leiste- Baguette- Listello- Listón 	1	95x44	3924
Sla4	Slat- Leiste- Baguette- Listello- Listón 	1	95x44	4961
Sla5	Slat- Leiste- Baguette- Listello- Listón 	2	95x44	3166
FB2-1	Floor board- Fussbodenbrett- Madrier du plancher - Tavola pavimento- Tabla de suelo 	98	89x19	2569
TB2-1	Terrace board- Terrassenbrett- Madrier de terrasse- Tavola terrazzo- Tabla de terraza 	5	120x28	4892
TB2-2	Terrace board- Terrassenbrett- Madrier de terrasse- Tavola terrazzo- Tabla de terraza 	5	120x28	3891
FB5-1	Ceiling board- Dachbodenbrett- Madrier du Grenier- Tavola soffitta- Tabla de techo 	9	95x19	4888
FB5-2	Ceiling board- Dachbodenbrett- Madrier du Grenier- Tavola soffitta- Tabla de techo 	9	95x19	3807
FB5-5	Ceiling board- Dachbodenbrett- Madrier du Grenier- Tavola soffitta- Tabla de techo 	10	95x19	2312
WG6-1	Water gutter- Wasserleiste- Rejet d'eau- Protección de lluvia- Protezione dalla pioggia- QP81x58x...HA 	4		2380
WG6-2	Water gutter- Wasserleiste- Rejet d'eau- Protección de lluvia- Protezione dalla pioggia- QP81x58x...HA 	4		1830
UL1	Ukse laudis 	6	70x12	2250
UL2	Ukse laudis 	1	70x12	950
UL3	Ukse laudis 	2	70x12	2165
UL4	Ukse laudis 	2	19x95	2165
UL5	Ukse laudis 	1	19x95	945

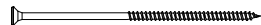
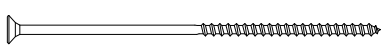
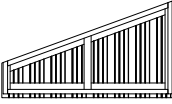
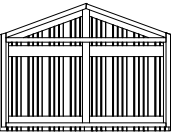
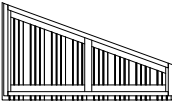

Pos	SPECIFICATION-STÜCKLISTE-NOMENCLATURE-ELEMENTI-ESPECIFICACIÓN EL18-9034-2-3	Pcs	Profile (mm)	Length (mm)
RoR1	Beam- Balken- Poutre- Trave- Viga 	17	140x44	504
RoR2	Beam- Balken- Poutre- Trave- Viga 	34	140x44	1799
RoR3	Beam- Balken- Poutre- Trave- Viga 	17	140x44	3353
Pst1	Post- Pfosten- Poteau- Montante- Poste 	4	65x160	2550
RB2-1	Roof board- Dachbrett- Madrier du toit- Tavola tetto- Tabla de tejado 	43	89x19	5048
RB2-2	Roof board- Dachbrett- Madrier du toit- Tavola tetto- Tabla de tejado 	43	89x19	3967
WG12-1	Water gutter- Wasserleiste- Rejet d'eau- Protección de lluvia- Protezione dalla pioggia- QP124x124x...HA 	4		1900
WG11-1	Water gutter- Wasserleiste- Rejet d'eau- Protección de lluvia- Protezione dalla pioggia- QP189x125x...HA 	8		2450
QNA2 2x50Zn	Nail- Nagel- Clou- Chiodo- Clavo- 2.5x50mm 	800	FB2-1	
QNA3 x70Zn	Nail- Nagel- Clou- Chiodo- Clavo- 3x70mm 	900	RB2-1 RB2-2	
QKRPP4 5x60Zn	Screw- Schraube- Vis- Vite- Tornillo- 4.5x60mm 	840	EL1+EL2+EL3 EL6, 7, 8	
QKRK K4_8 x28MU	Screw- Schraube- Vis- Vite- Tornillo- 4.8x28mm MU 	60		
QKRPP5 x80ZnTX	Screw- Schraube- Vis- Vite- Tornillo- 5x80mm 	250	EL6, 7, 8 EL1, EL2, EL3+AR1, 2... EL1, EL2, EL3+AR1, 2, 3, 4, 5	
QKRPP P6x1 20ZnTX	Screw- Schraube- Vis- Vite- Tornillo- 6x120mm TX 	50	BM1 BM4 RoR1, 2, 3	
QKRPP 6x160 ZnTX-1	Screw- Schraube- Vis- Vite- Tornillo- 6x160mm TX-1 	170	AR1, 2, 3... RoR1, 2, 3	
QKRPP 8x240 kZnTX	Screw- Schraube- Vis- Vite- Tornillo- 8x240mm 	140	RoR1, 2, 3	
EL12		2	1087X597x20	
EL7		2	1087X795X597	
EL15		2	1087X597x20	
	Object name EL18-9034-2-3		Page 1/1	

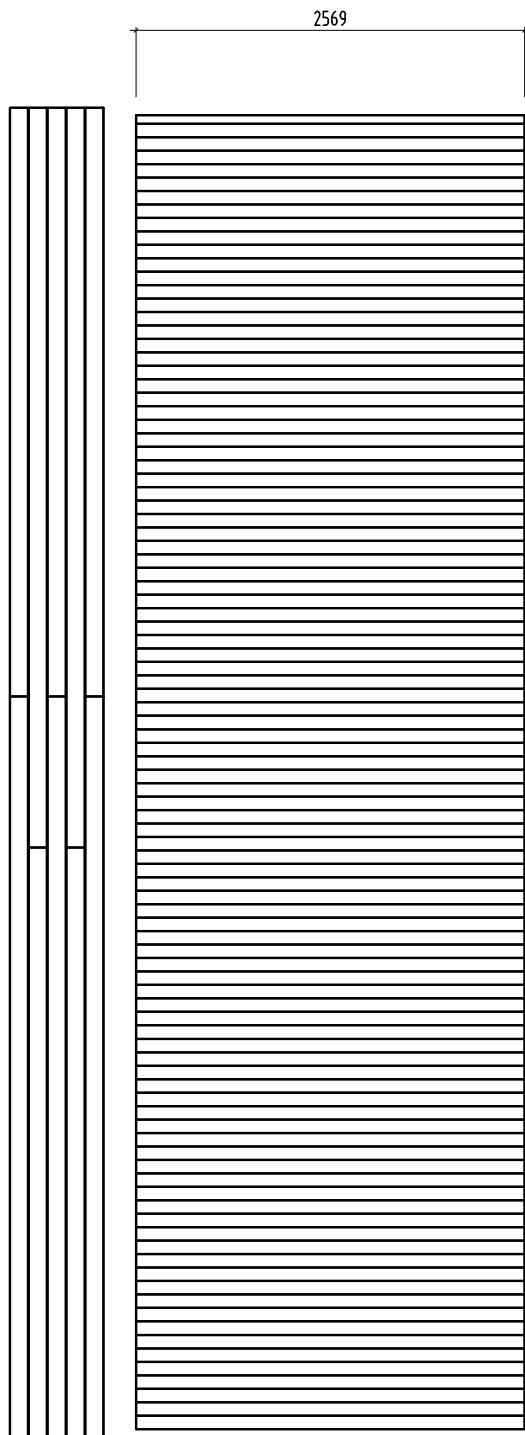

Floor + Terrace plan

NB!

1.

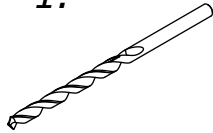

2.

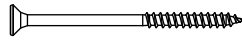

$\varnothing 1,5 \text{ mm}$	$\varnothing 3,0...4$
$\varnothing 2,0 \text{ mm}$	$\varnothing 4,5$
$\varnothing 3,0 \text{ mm}$	$\varnothing 5,0$

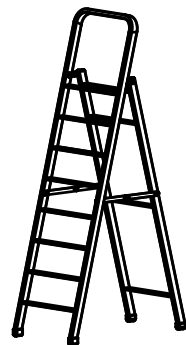
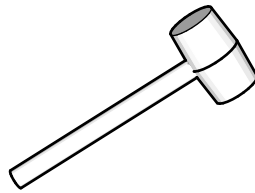
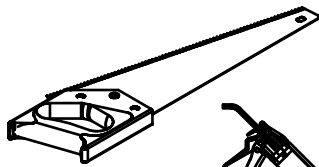
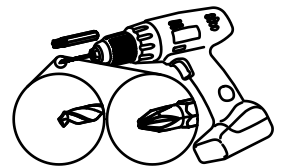
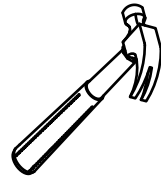
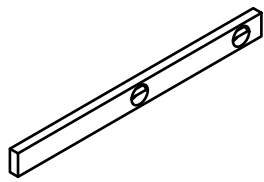
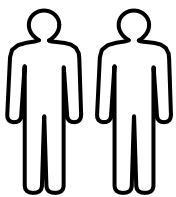
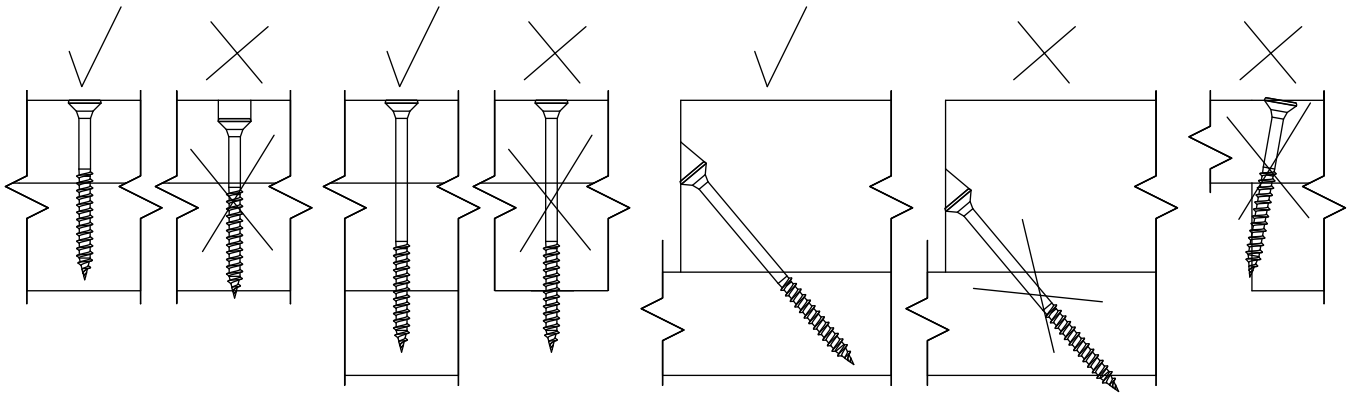

ENG	-	Not included
GER	-	Nicht enthalten
FR	-	Non inclus
ES	-	No incluso
IT	-	Non incluso
NO	-	Ikke inkludert
SWE	-	Ingår inte
FIN	-	Ei sisälly hintaan
DEN	-	Ikke inkluderet
NED	-	Niet inbegrepen
POR	-	Não incluído
CZ	-	Není zahrnuto
POL	-	Nie wliczone
LIT	-	Neįtraukta
LAT	-	Nav iekļauts
RUS	-	Не включено
EST	-	Ei sisaldu komplektis

ENG	-	Separate manual
GER	-	Separates Handbuch
FR	-	Manuel séparé
ES	-	Manual separado
IT	-	Manuale separato
NO	-	Separat manual
SWE	-	Separat manual
FIN	-	Erillinen käyttöohje
DEN	-	Separat manual
NED	-	Aparte handleiding
POR	-	Manual separado
CZ	-	Samostatný manuál
POL	-	Osobna instrukcja
LIT	-	Atskiras vadovas
LAT	-	Atsevišķa rokasgrāmata
RUS	-	Отдельное руководство
EST	-	Eraldi juhend

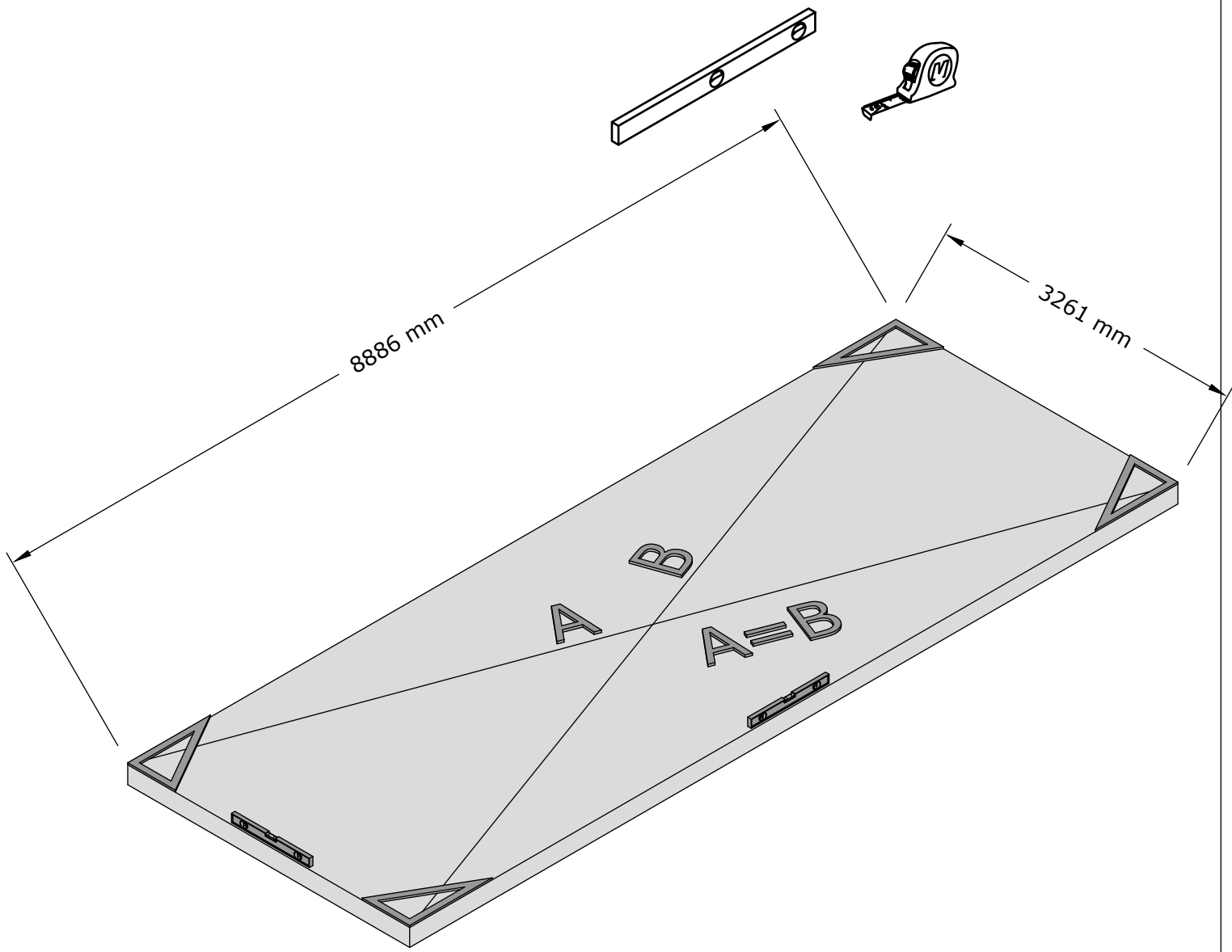

AR

*

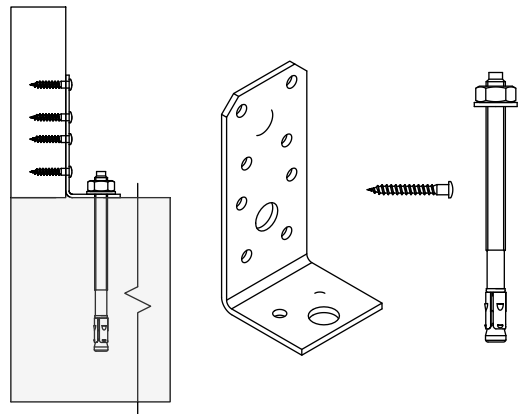

- AR1 x4
- AR2 x16
- AR3 x2
- AR4 x20
- AR5 x2

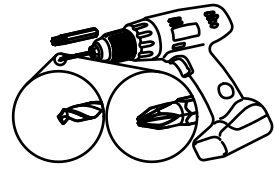
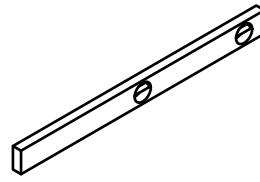

- 5x80 x90
- 6x160 x96

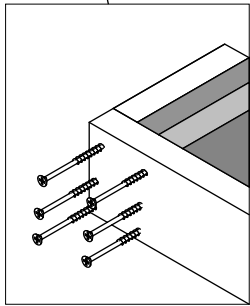
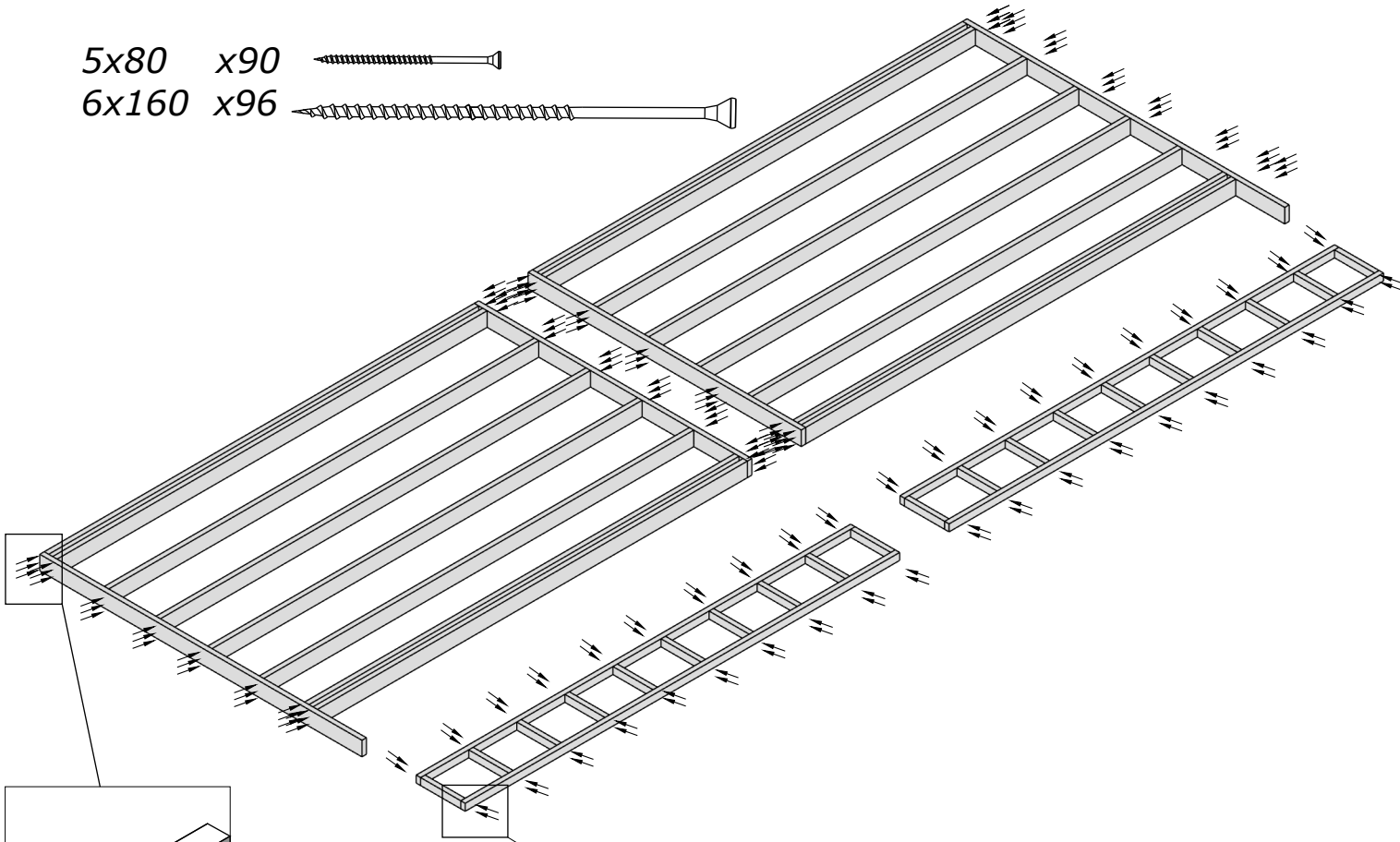
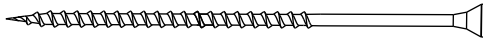
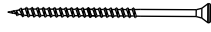

6x160

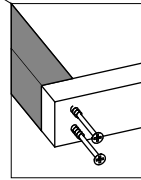

5x80

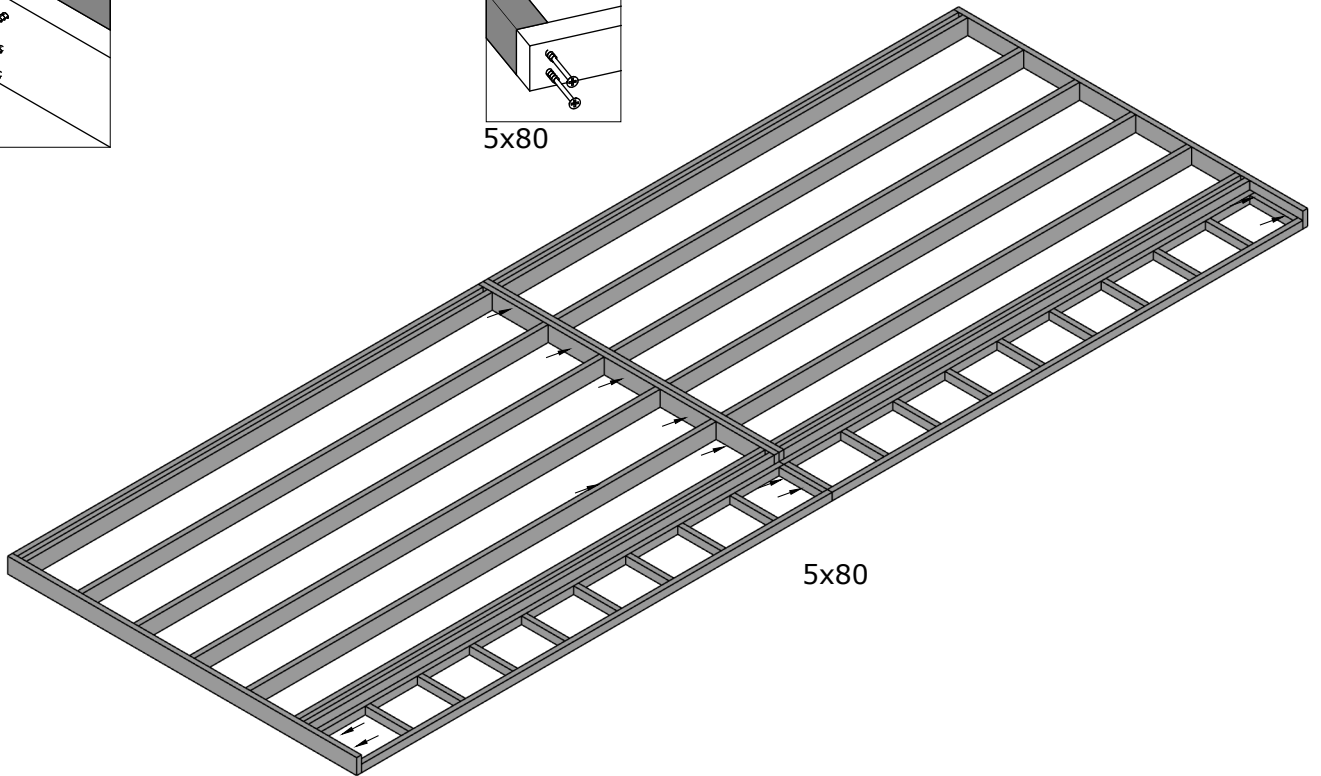

5x80

- AR1 x4
- AR2 x16
- AR3 x2
- AR4 x12
- AR5 x2

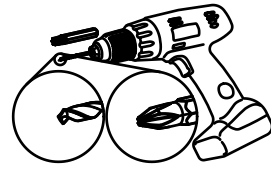
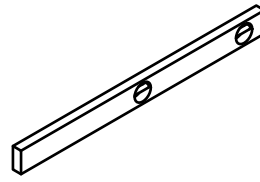

- 5x80 x90
- 6x160 x96

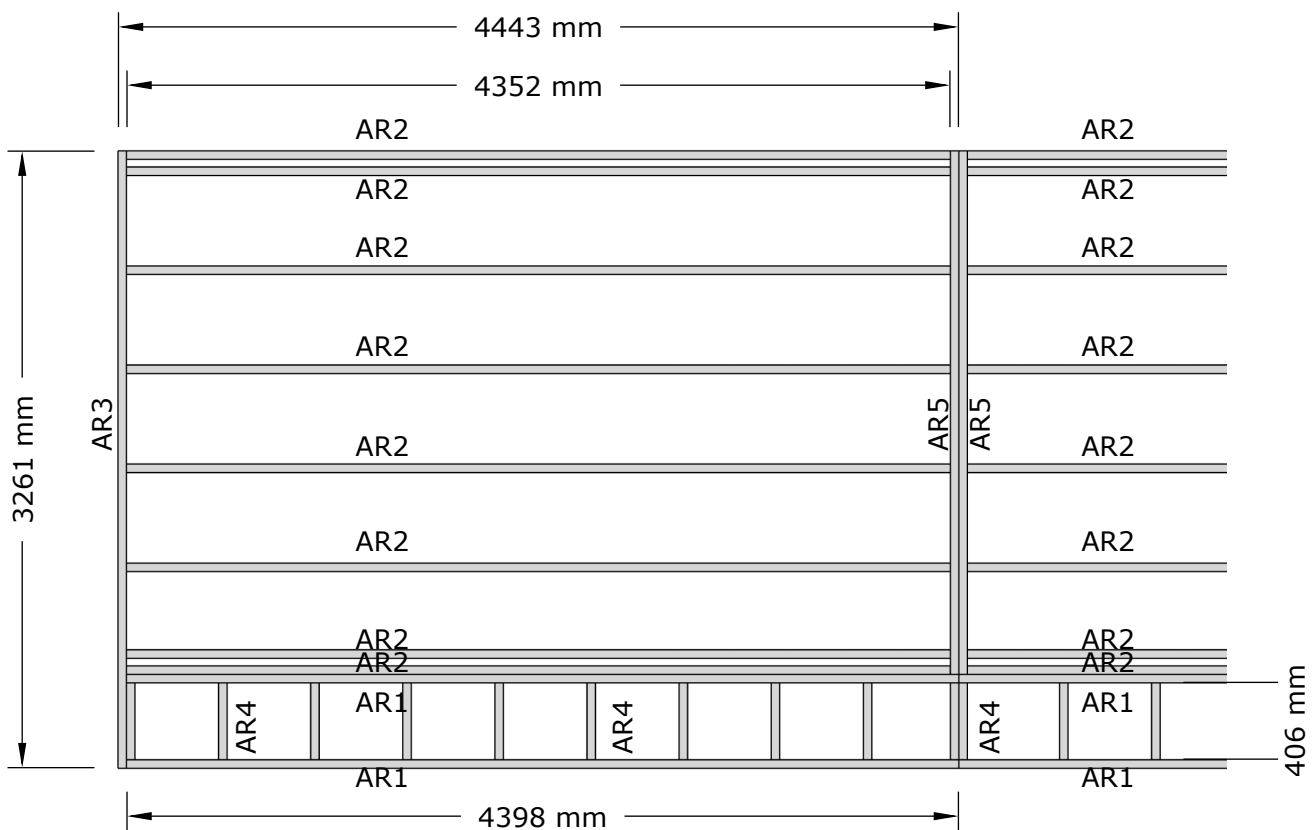
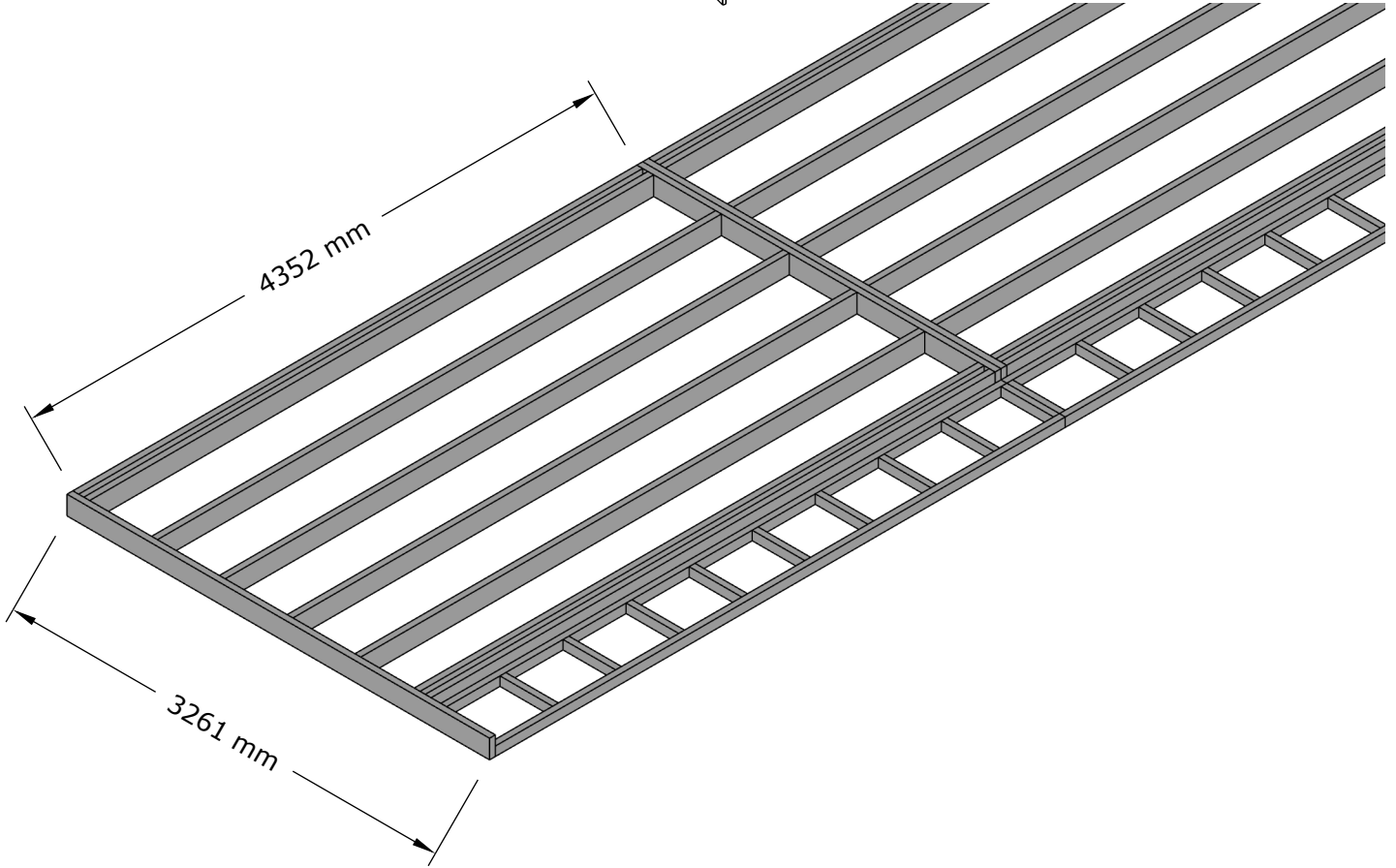
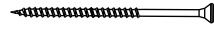

- E1 x17
- E3 x3
- E4 x2
- E5 x1

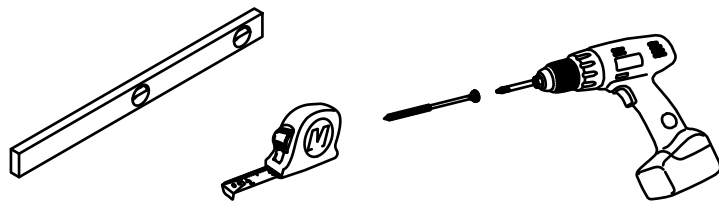

- 4,5x60 x84
- 5x80 X63

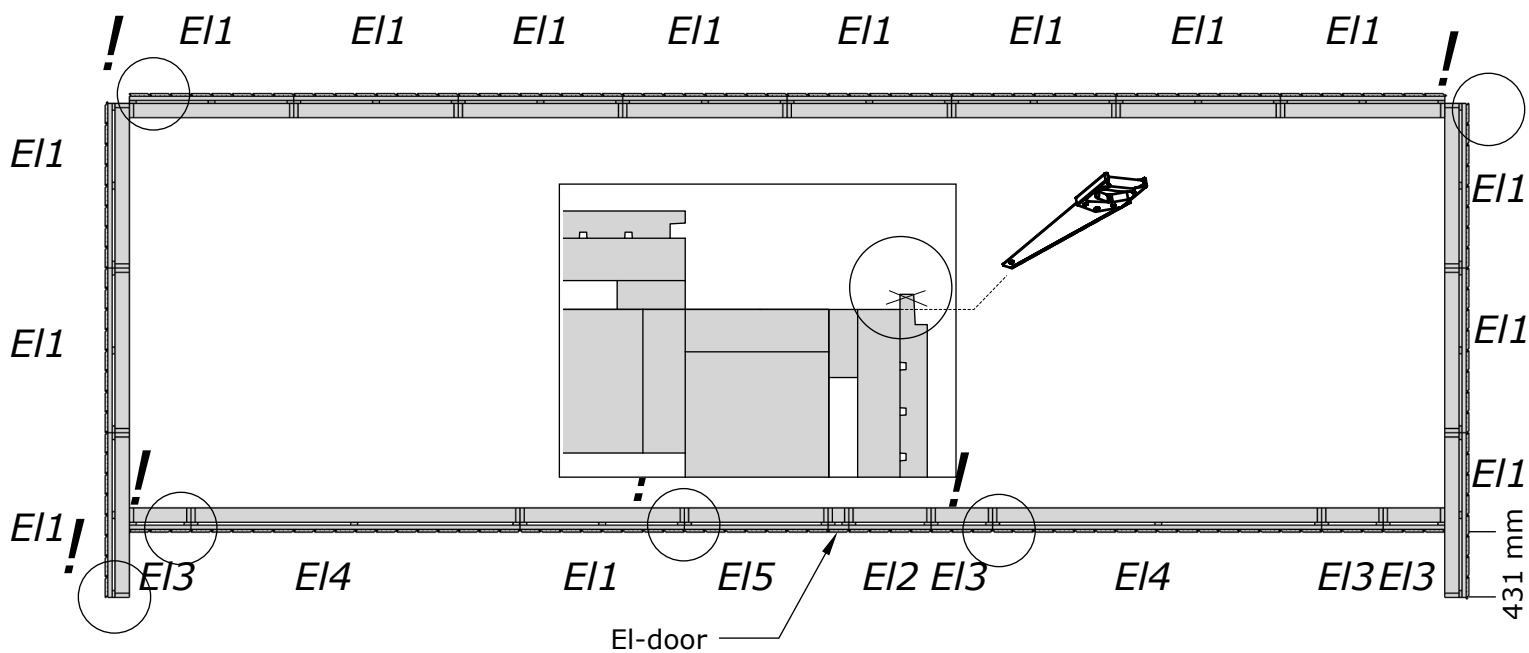
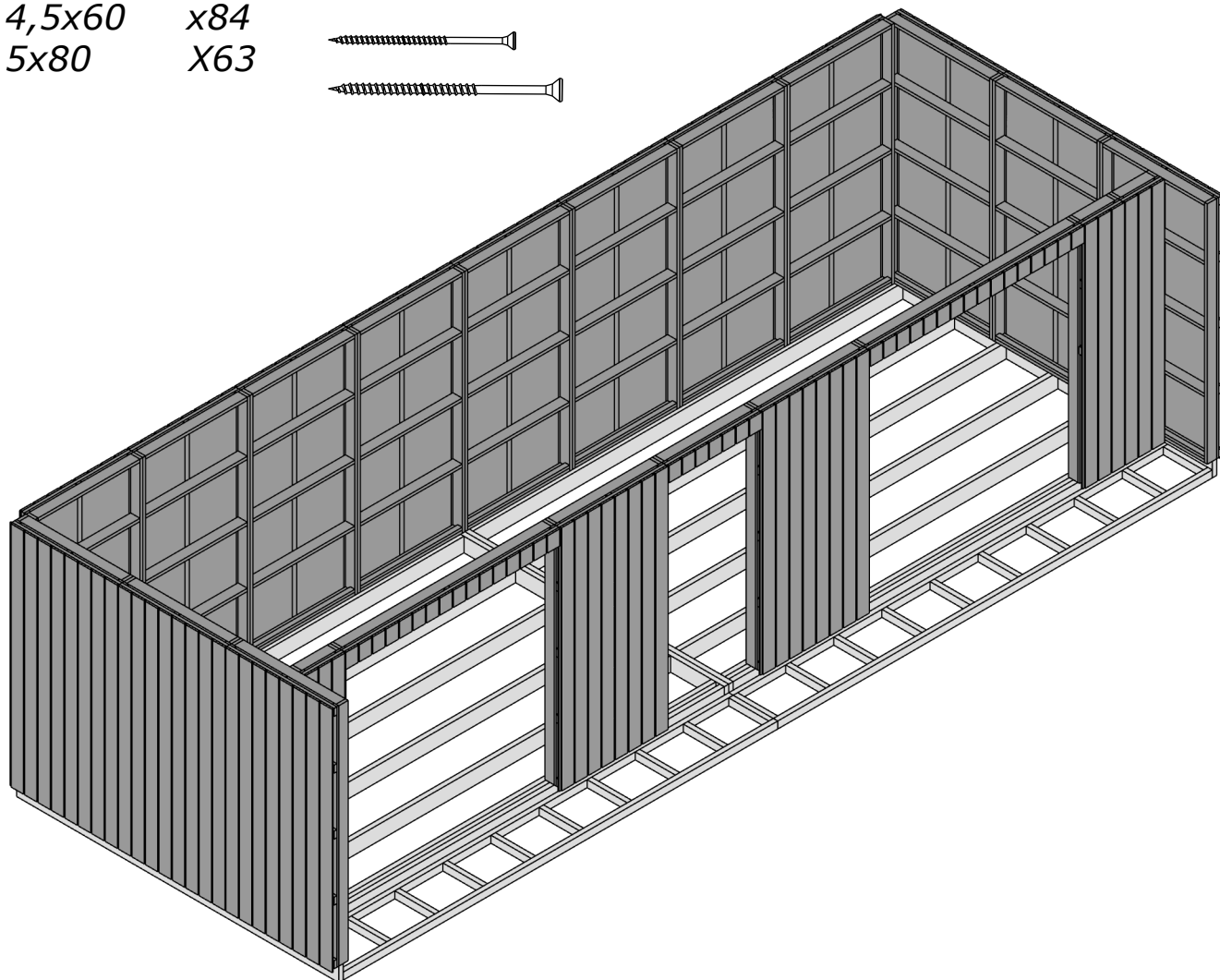
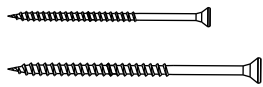

- E1 x11
- E2 x3
- E3 x1
- E4 x1
- E5 x1

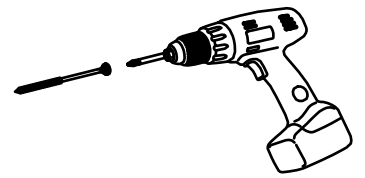
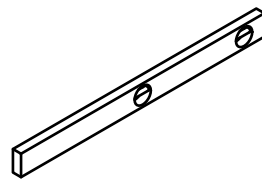

- 4,5x60 x84
- 5x80 x63

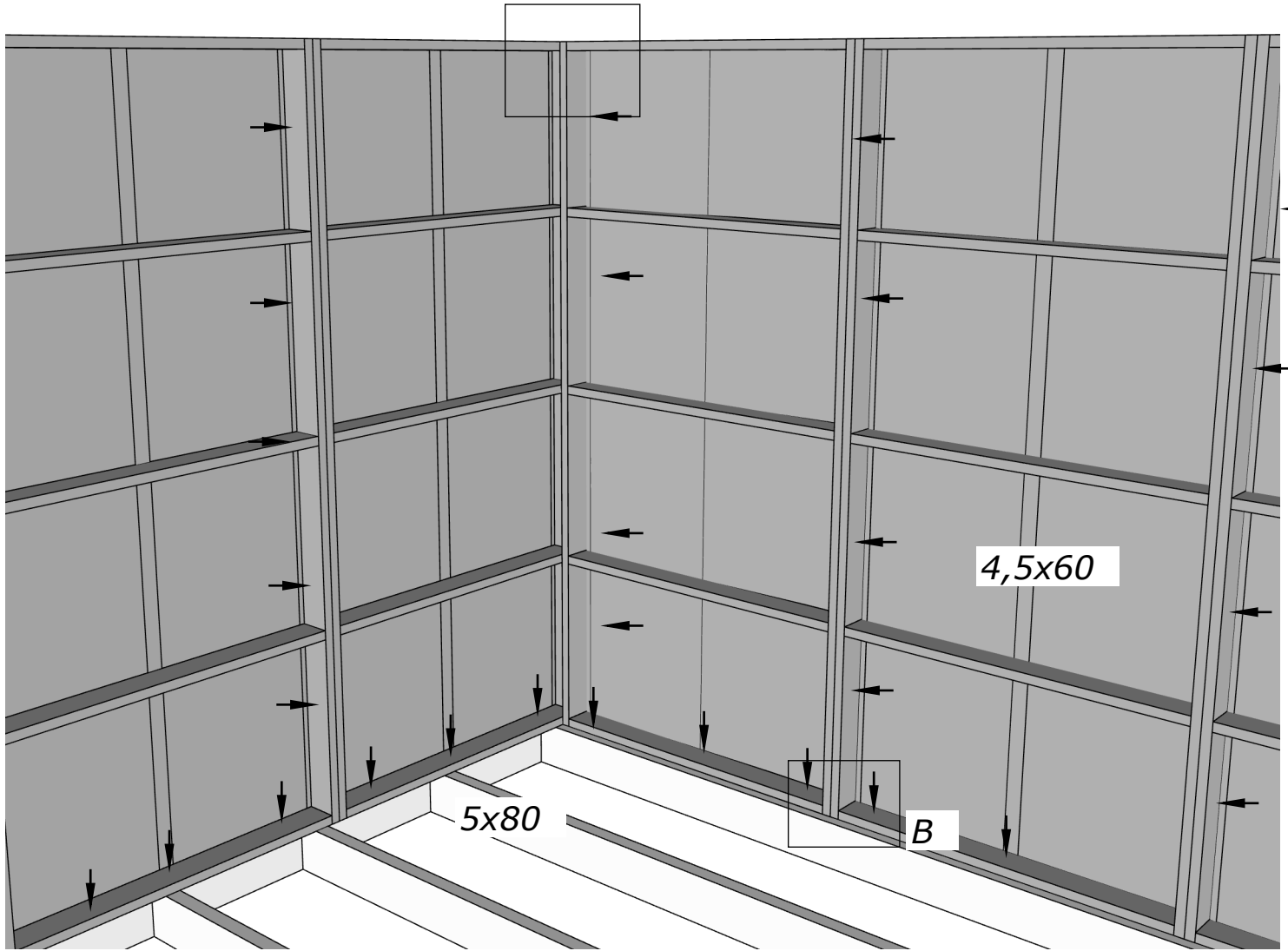
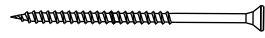
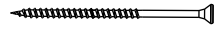

A

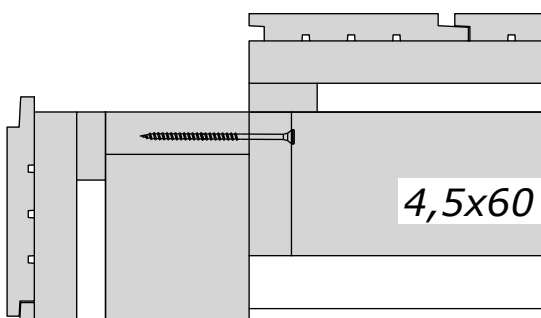

B

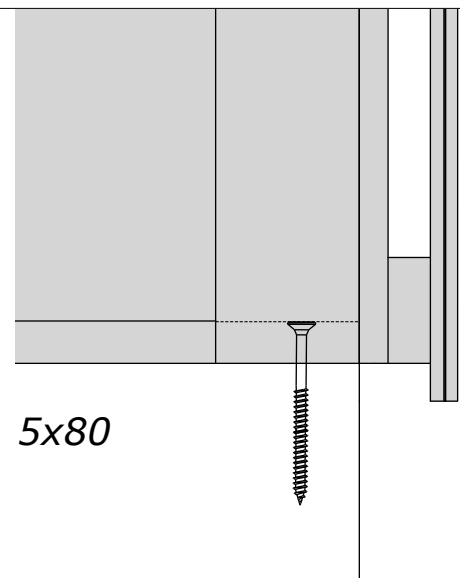

Sla2 x2
Sla3 x2

5x80 x33

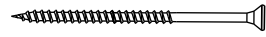

Sla2

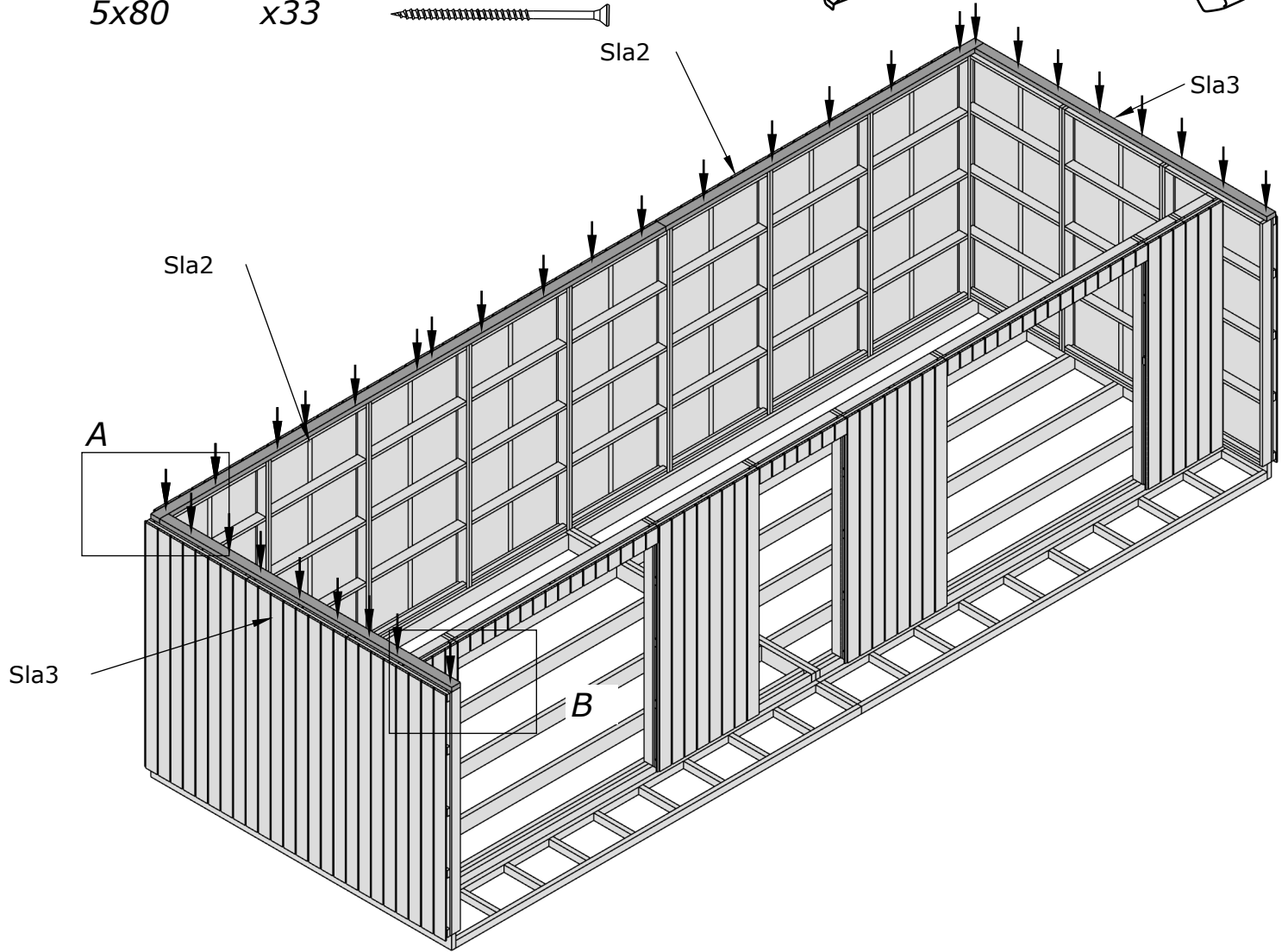
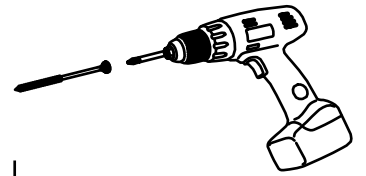
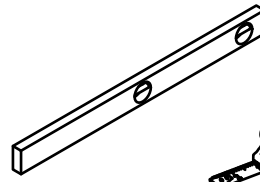

A

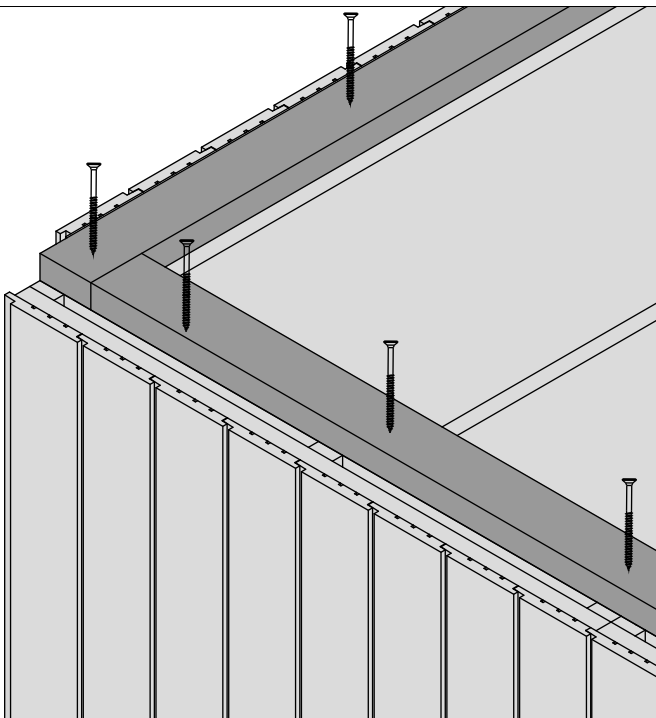

B

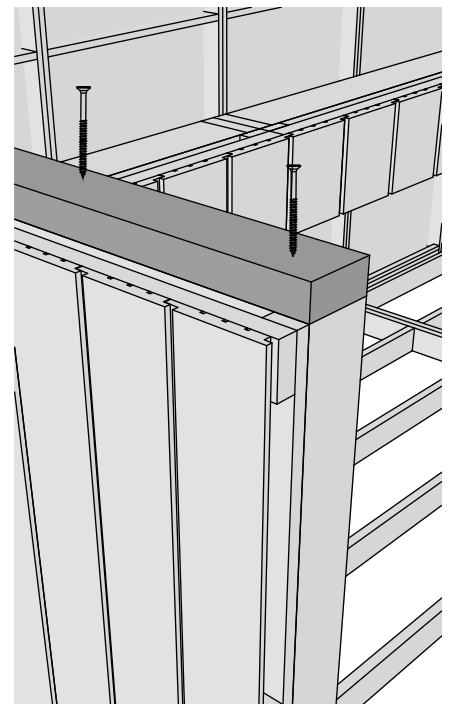

WG6-1 x4
WG6-2 x4

4,8x28 x25

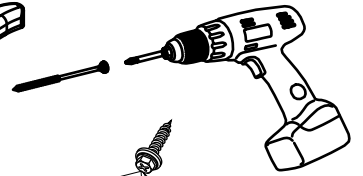
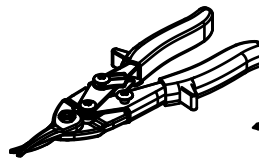

WG6-1

WG6-2

WG6-1

A

WG6-2

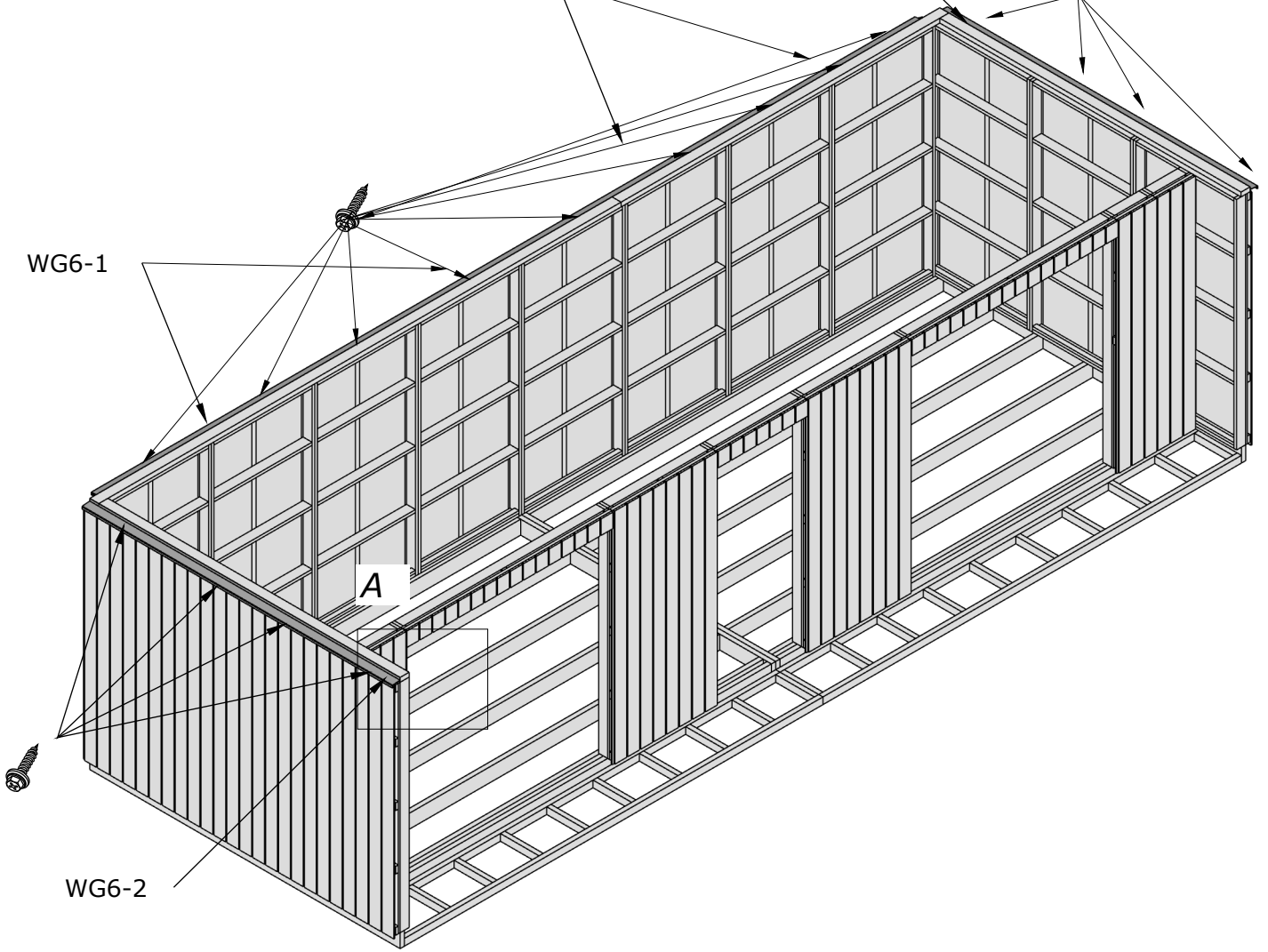

A

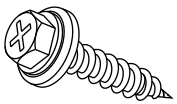

WG6

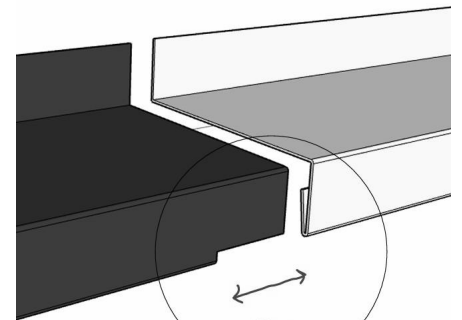
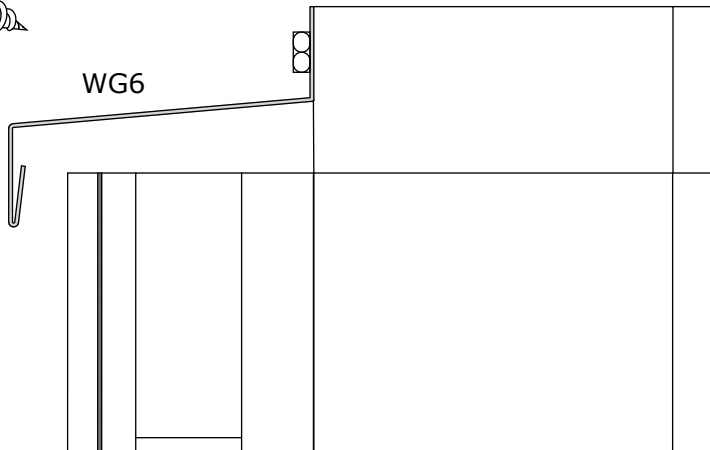

30 mm

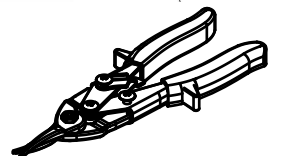

BM1 x1
BM2 x1

6X120 x16

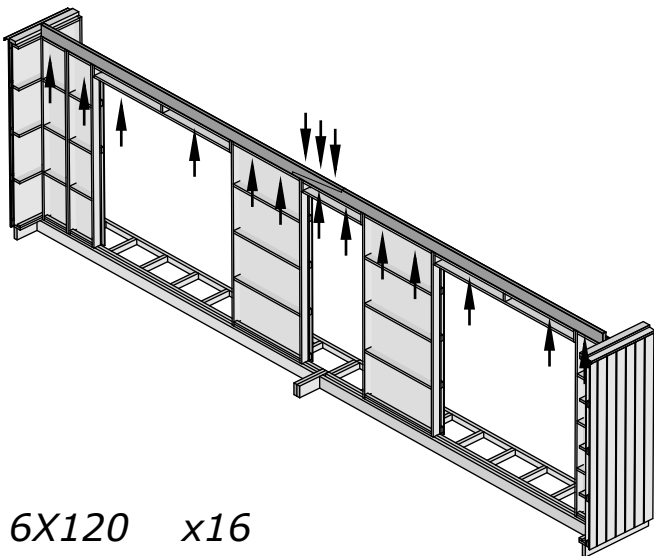
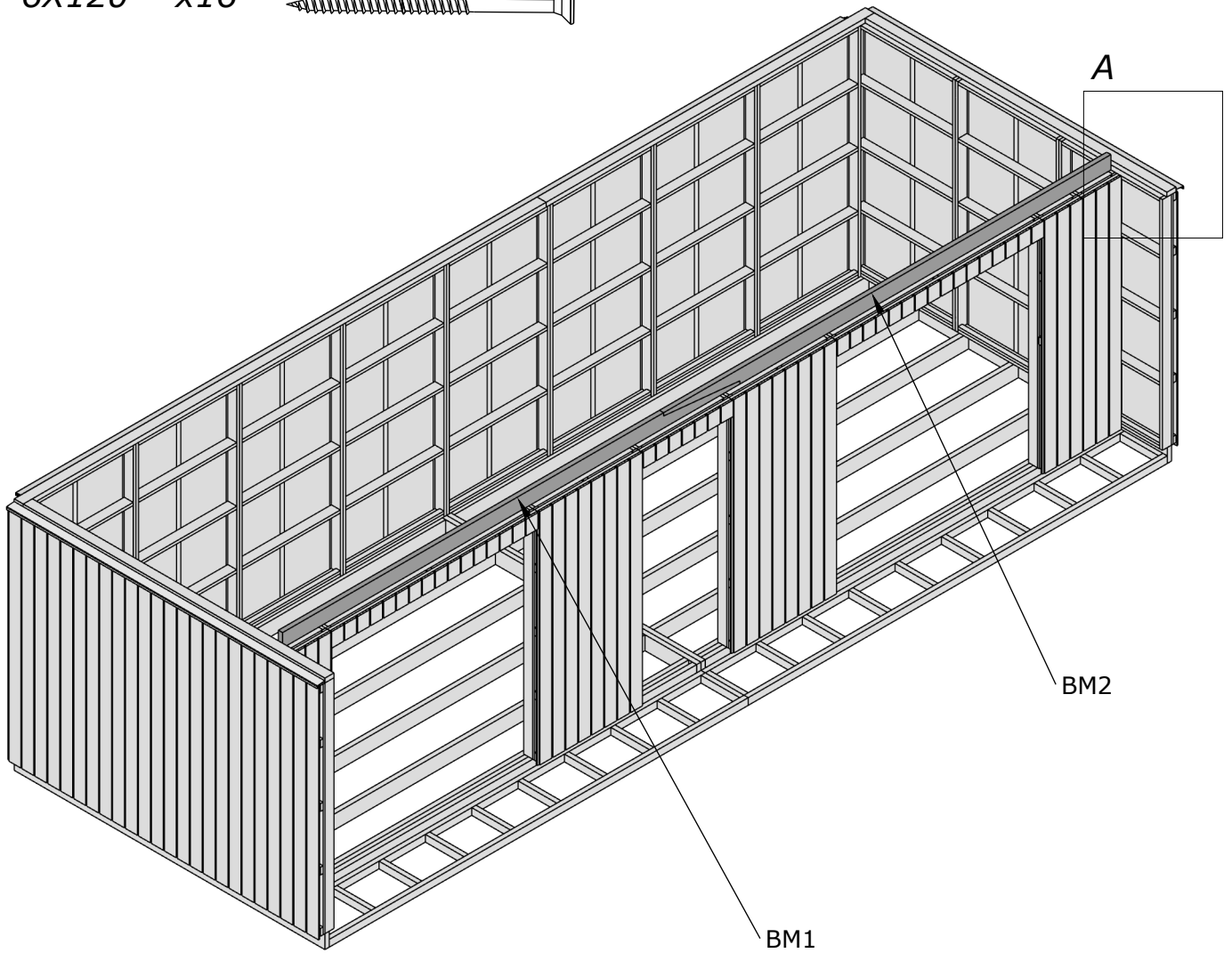
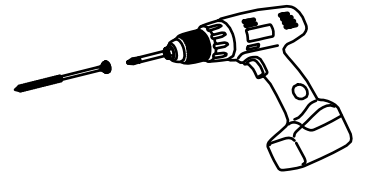
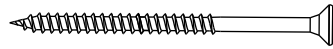

A

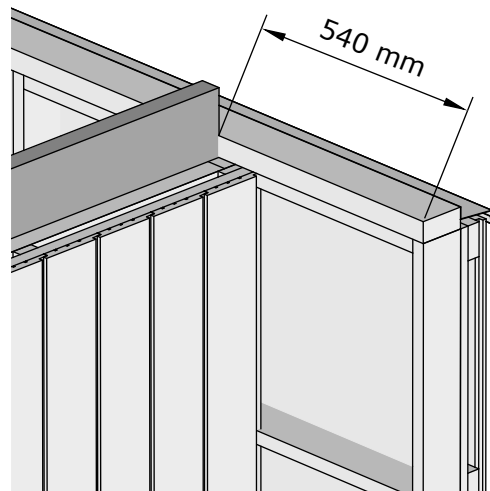

Sla1 x2
Sla2 x2

4,5X60 x20

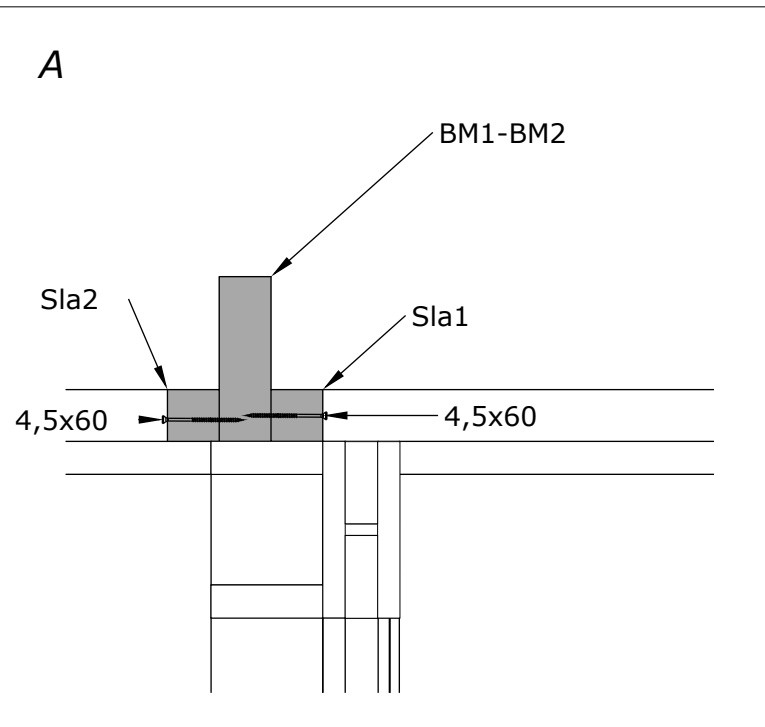
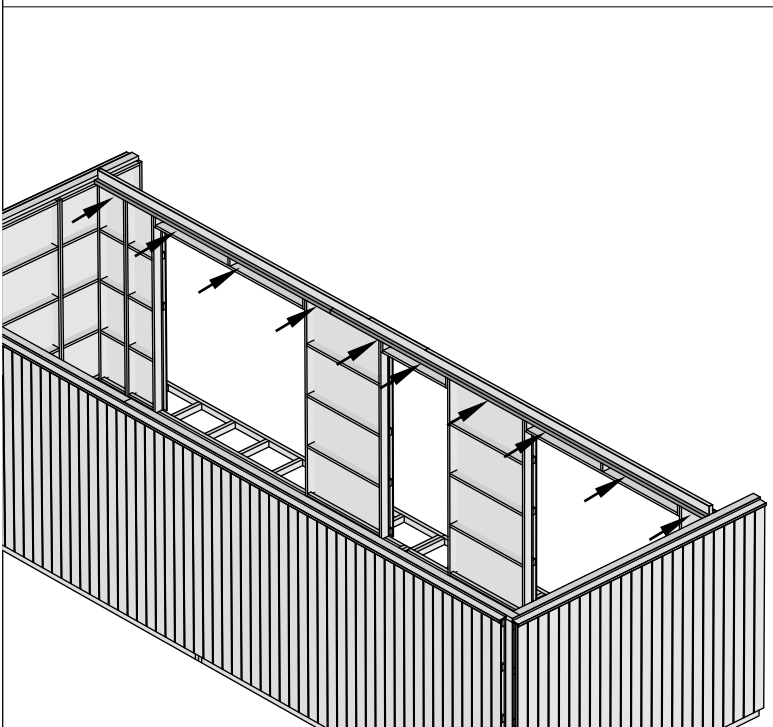
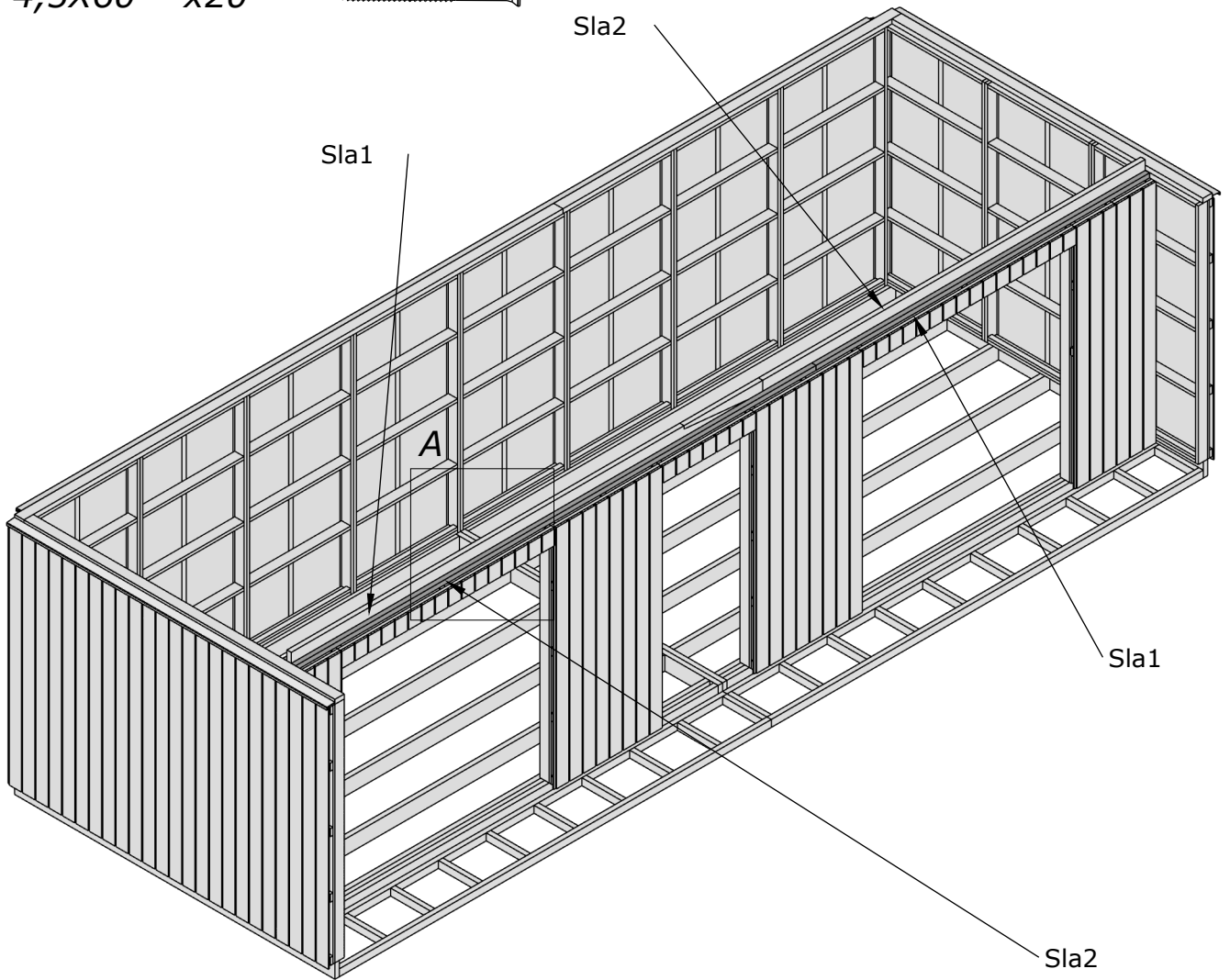
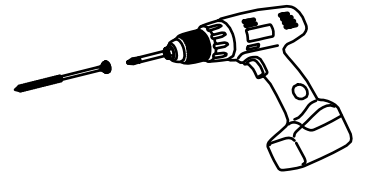
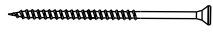

EI12 x2
EI7 x2
EI15 x2

4,5X60 x8
5X80 x18

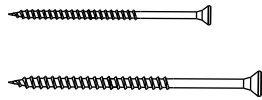

!

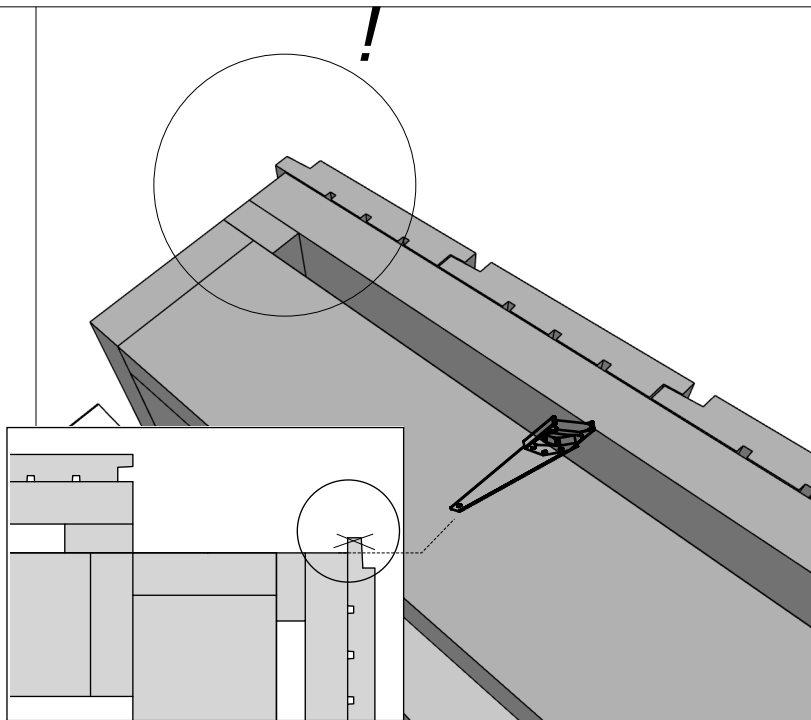
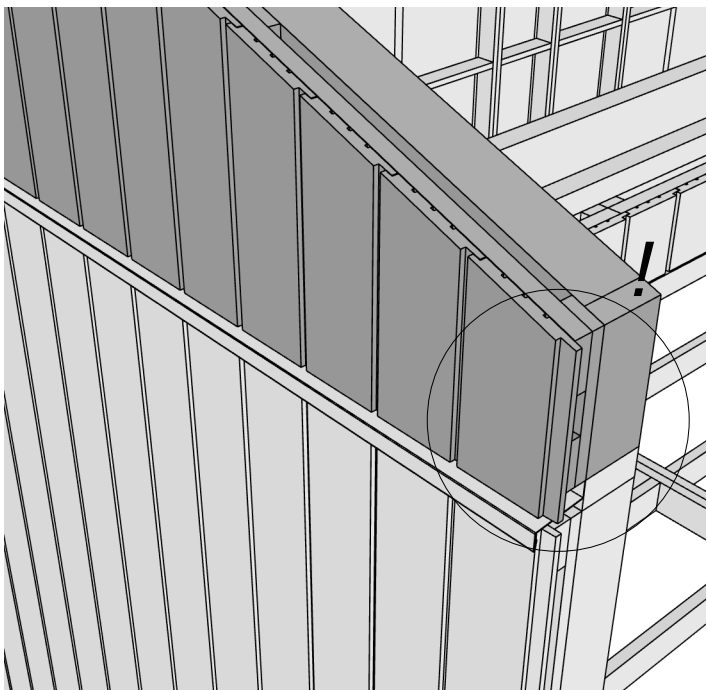
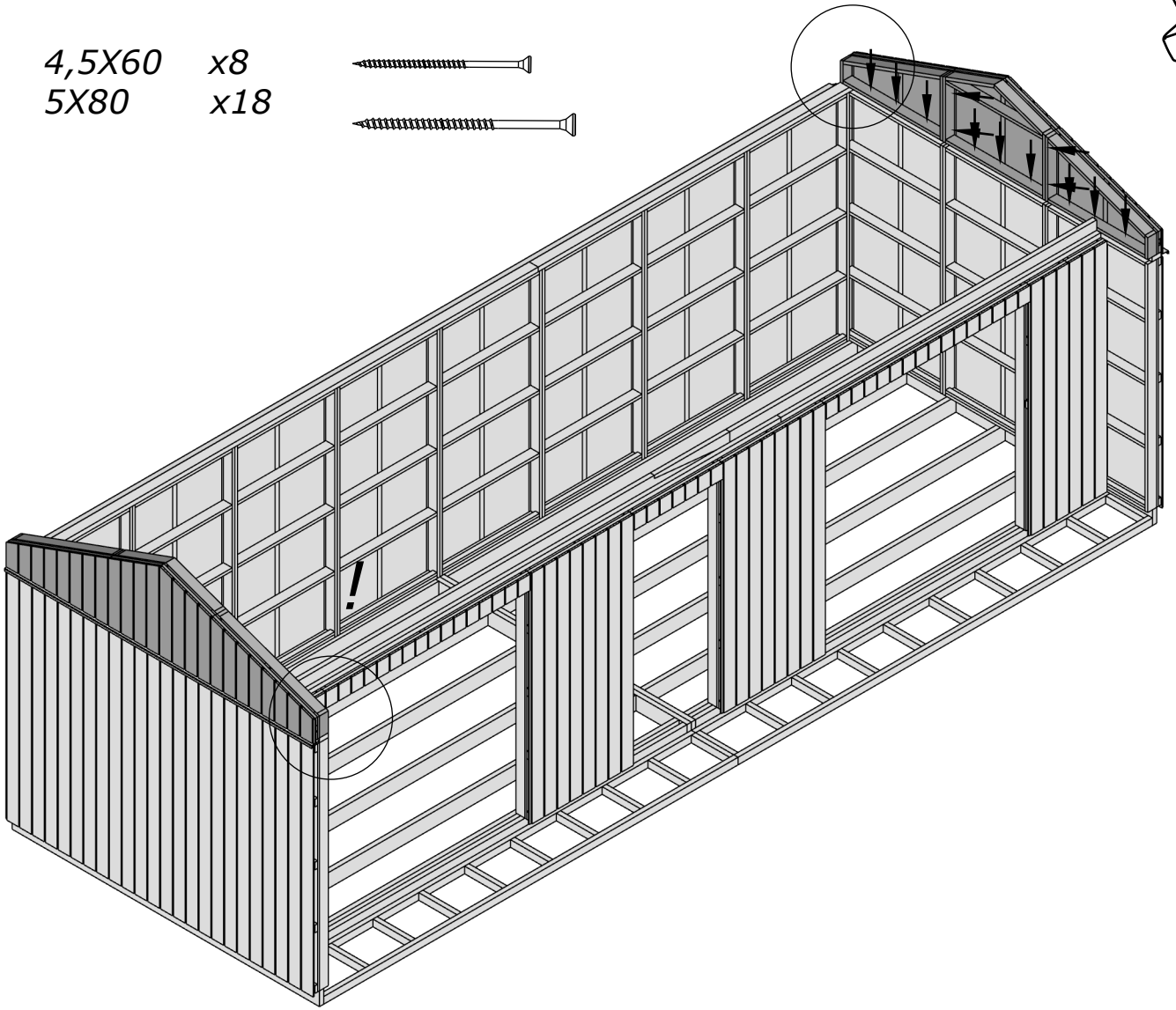
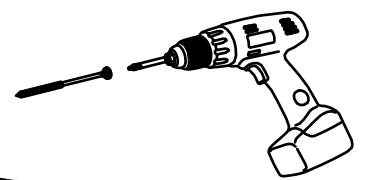

Pst1 x4

5X80 x16

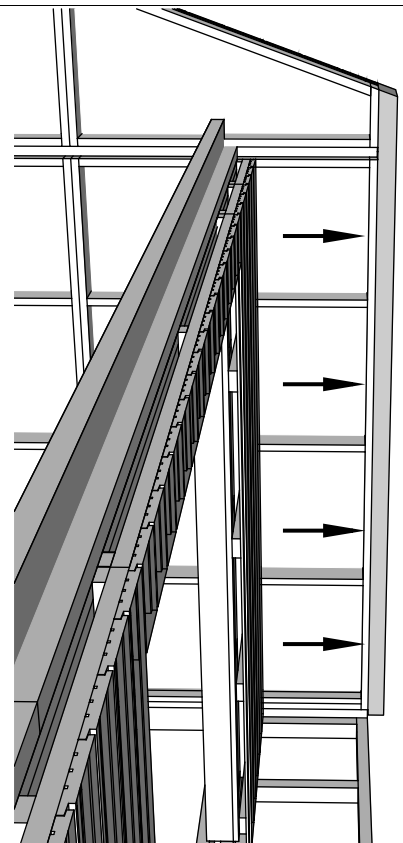
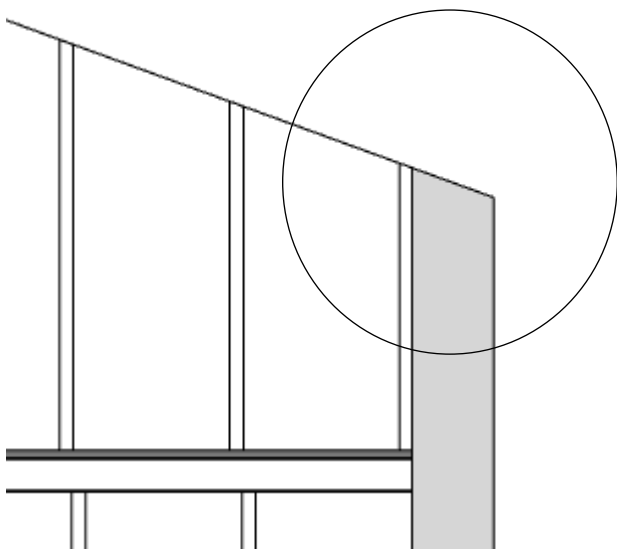
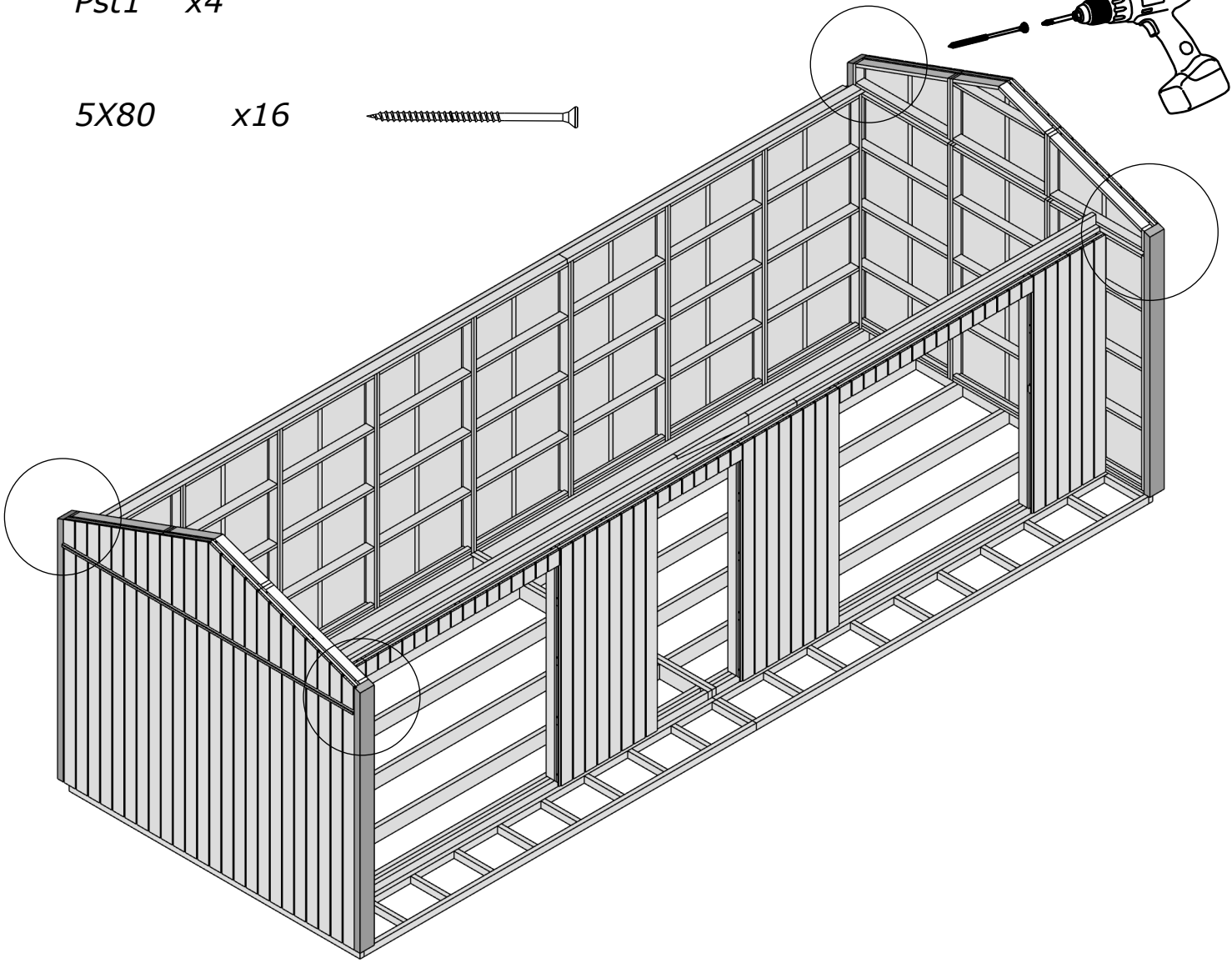
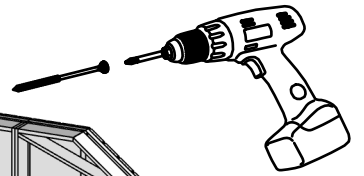
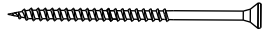

ELEL1 x6

ELEL2 x2

ELEL3 x16

ELEL4 x3

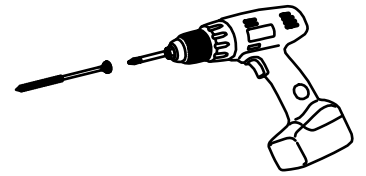

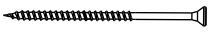
Ø4,5X60 x58 

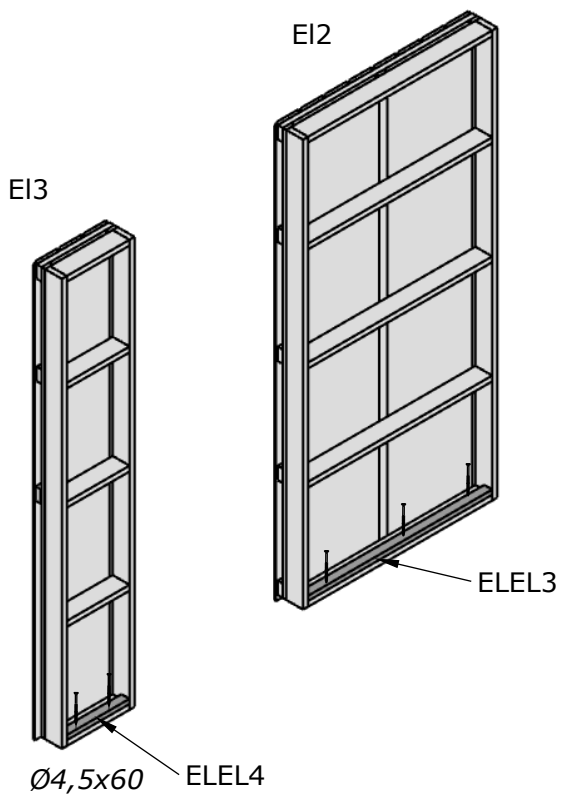
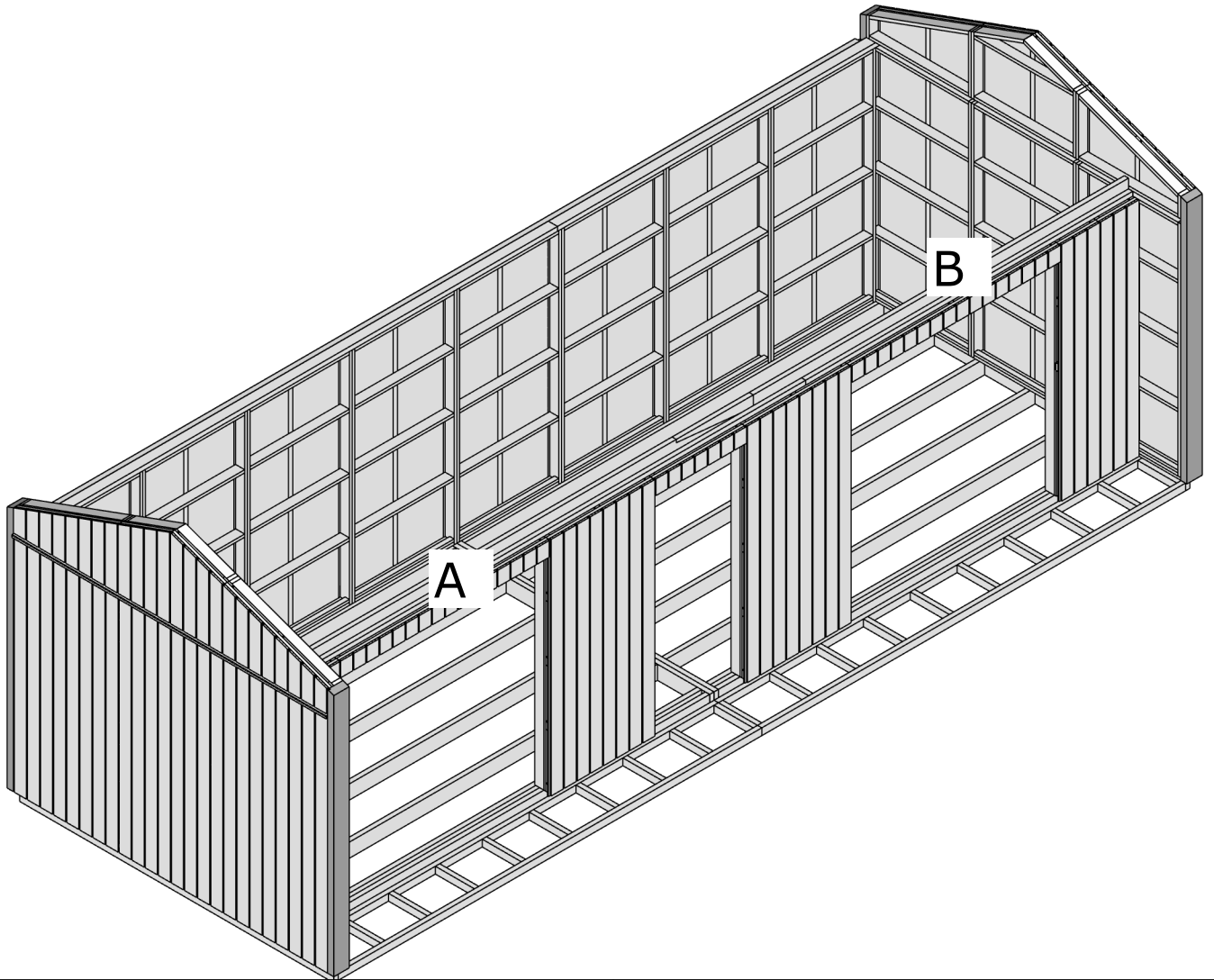

A - B

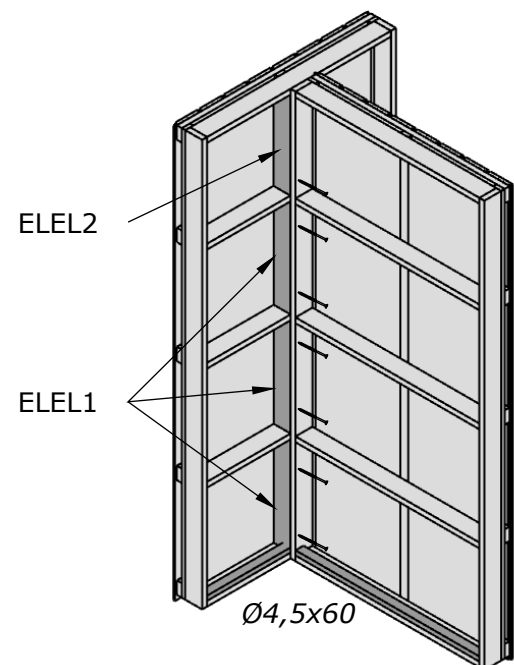

Ror1 x11
Ror2 x22
Ror3 x11

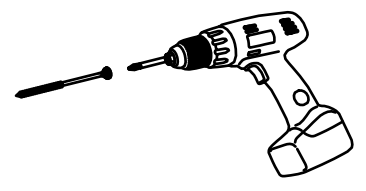

6X160 x34
8X240 x136

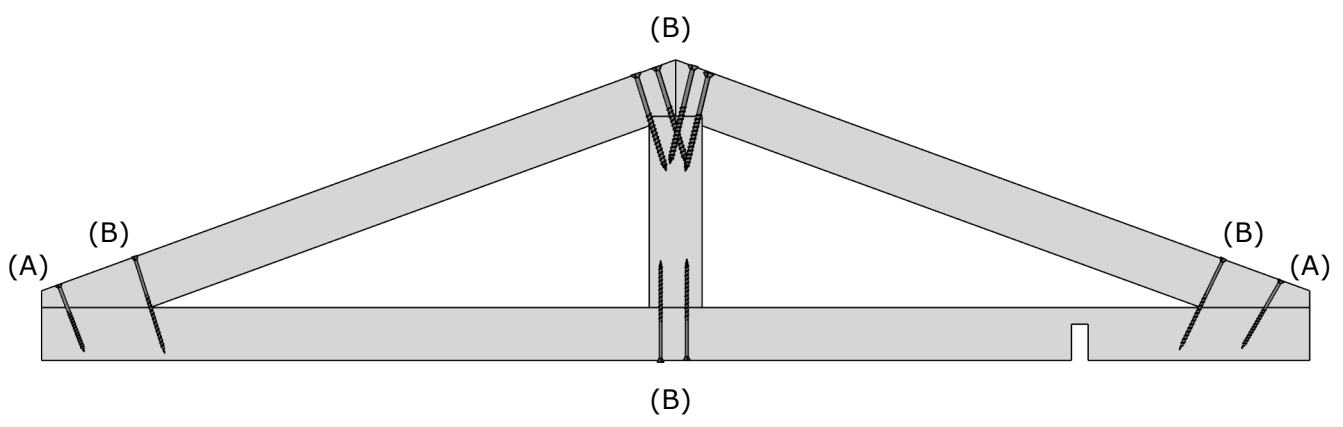
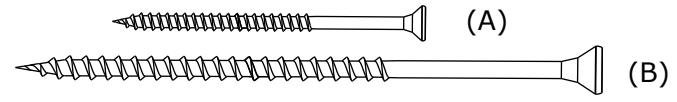

541 541 541 541 541 541 541 541 541 541 541 541 541 541 541 541

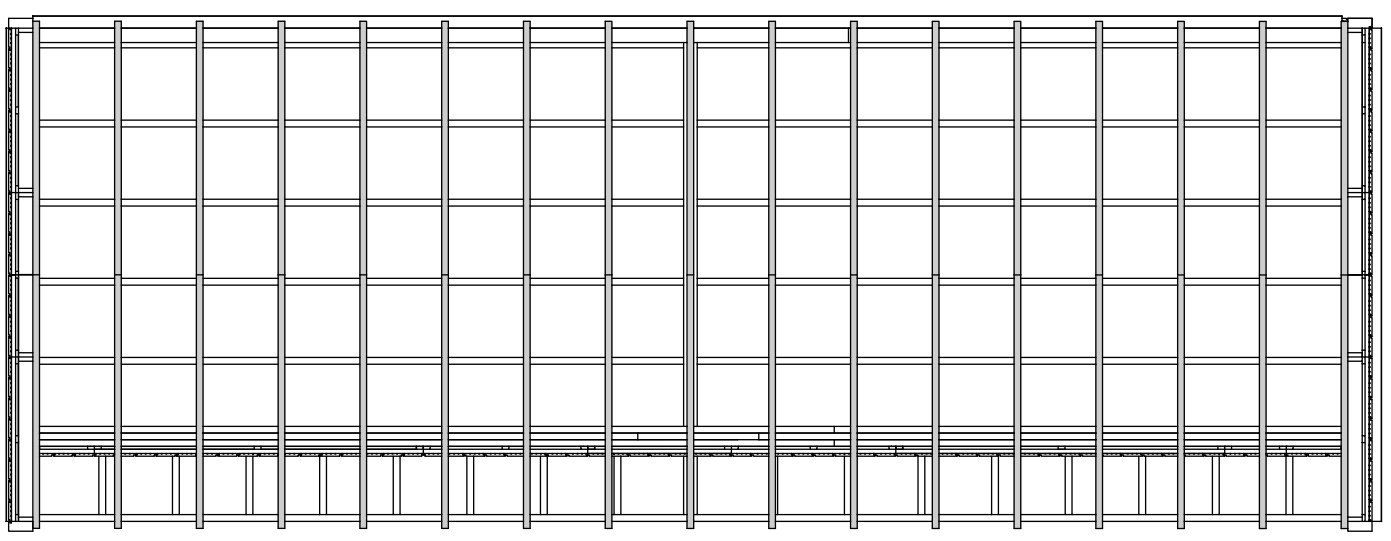

Ror

5x80 x16
6x120 x34
6x160 x34

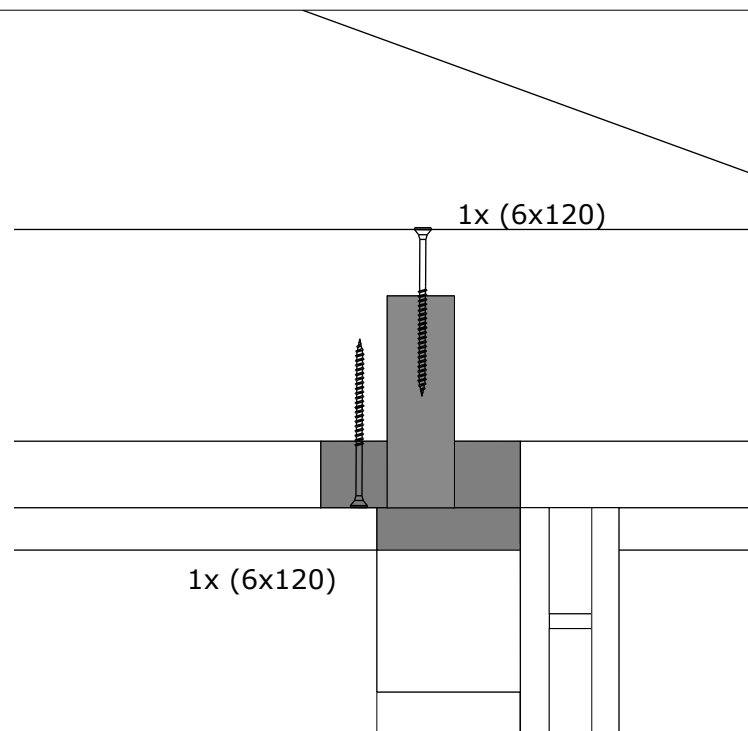
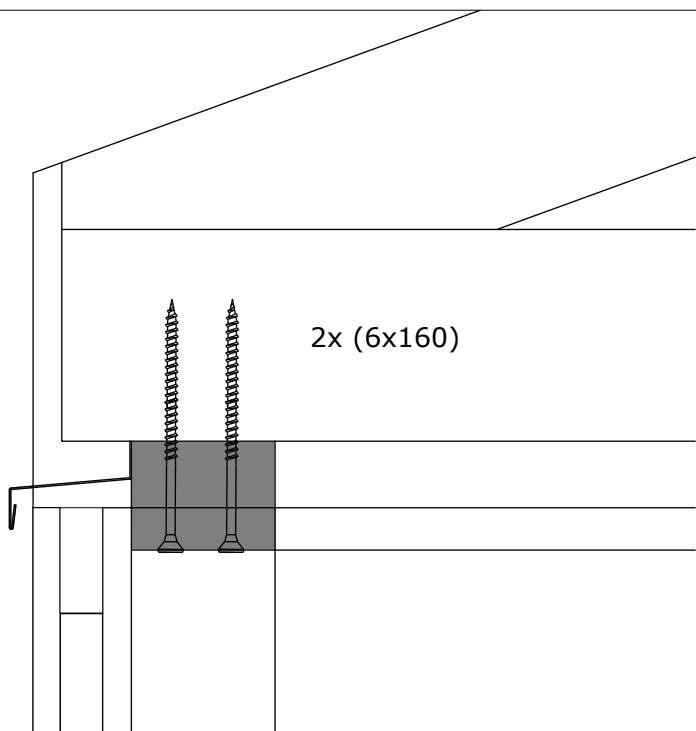
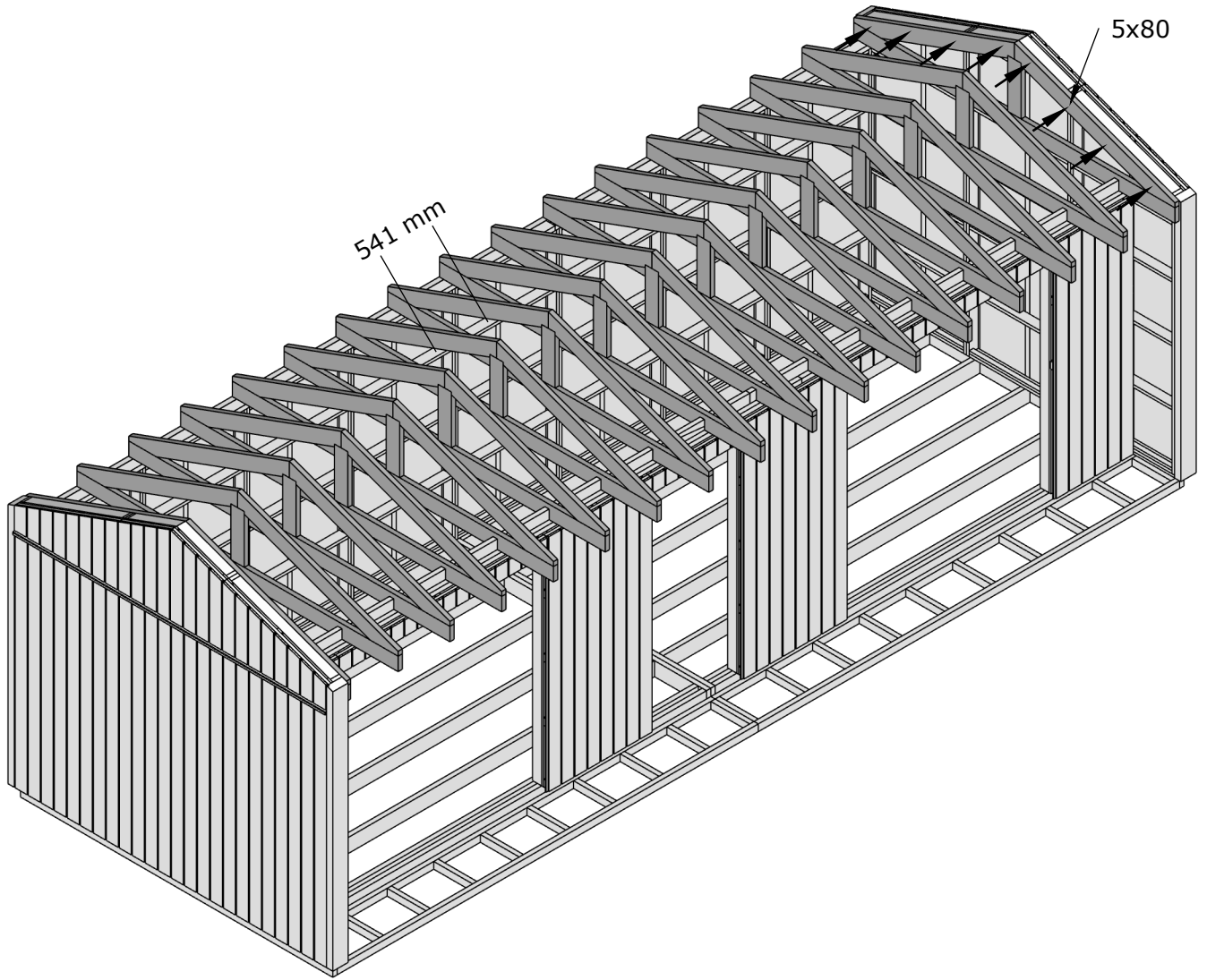
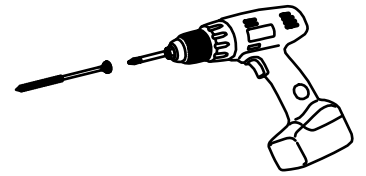
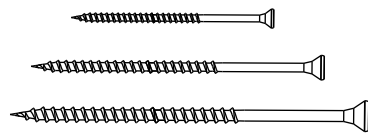

RB2-1 x43
RB2-2 x43

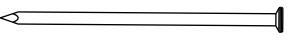
3x70 x900 

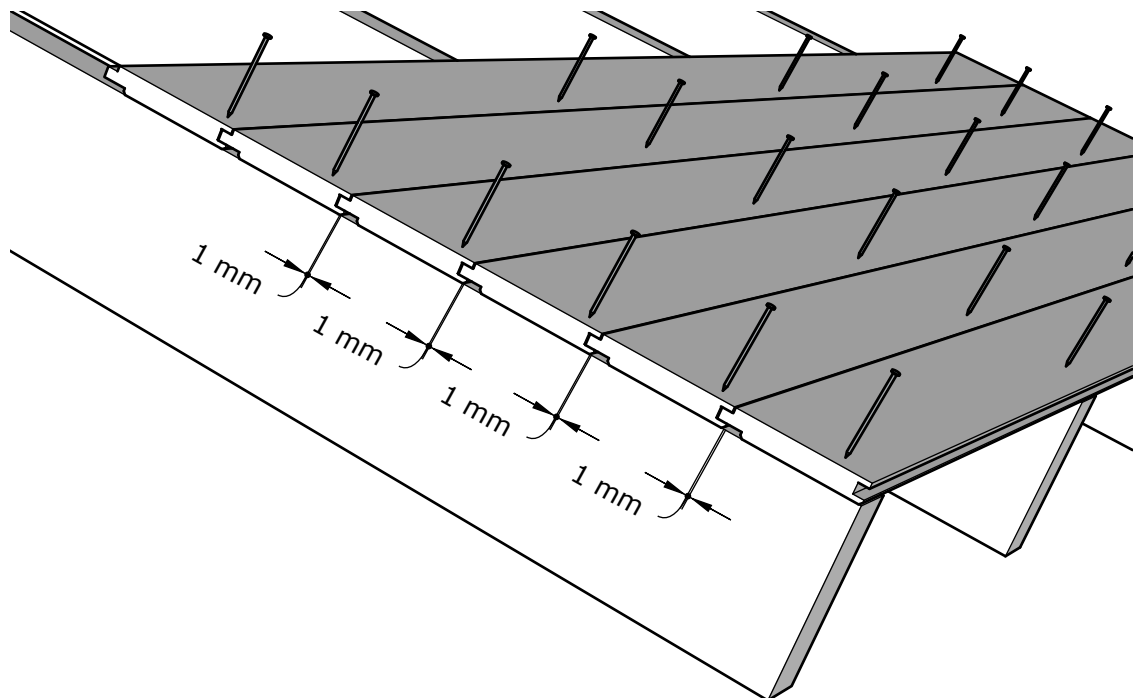
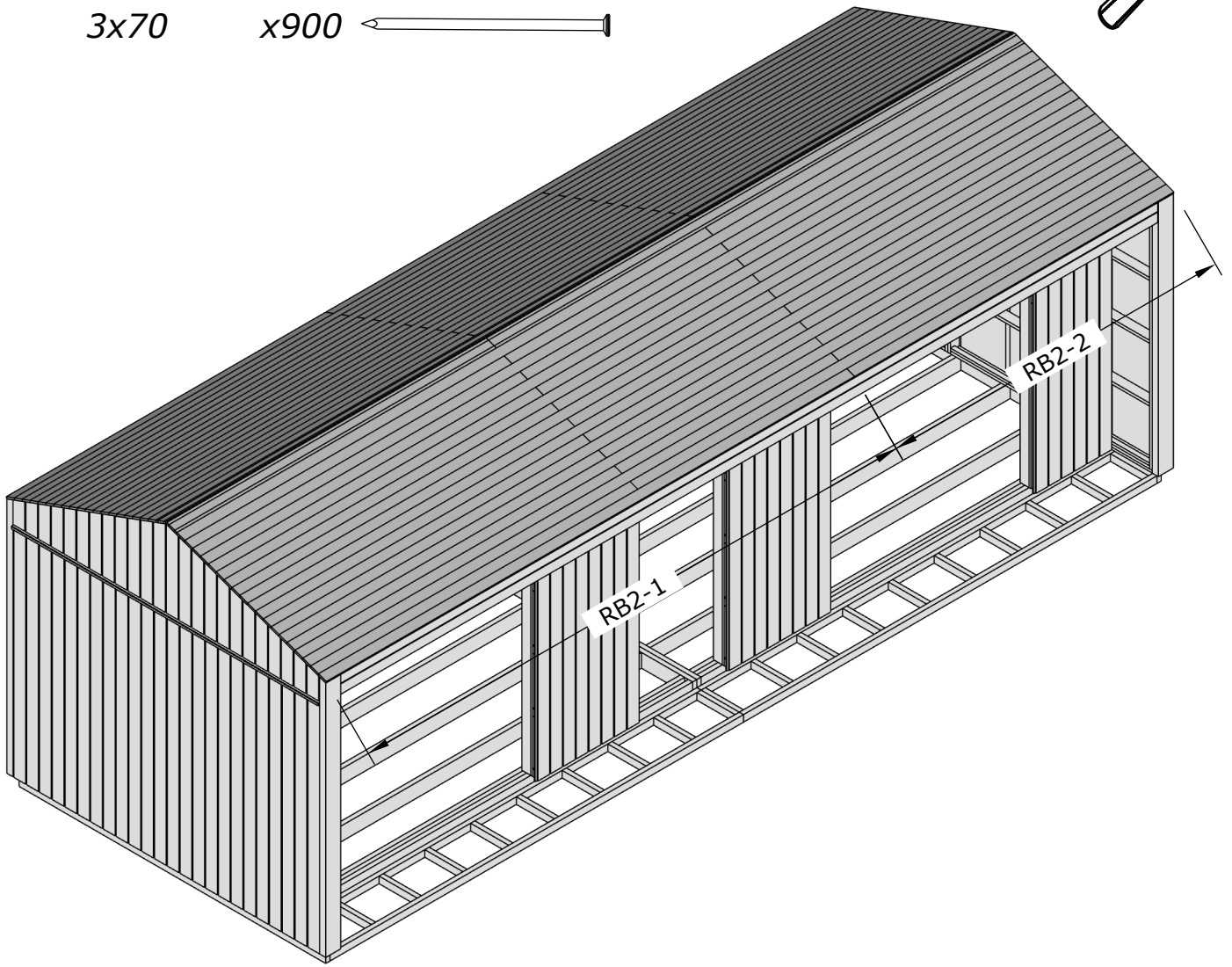
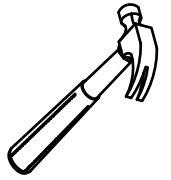

FB5-1 x9
FB5-2 x9

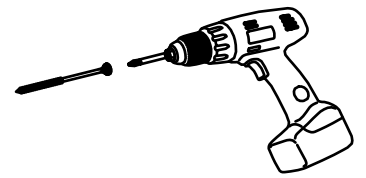

4,5x60 x310

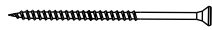

A

B

FB5_1

FB5-2

*

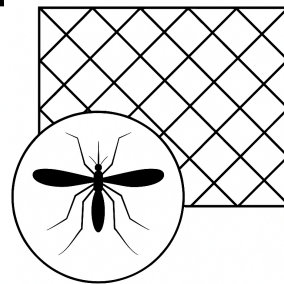

A

B

5 mm

5 mm

5 mm

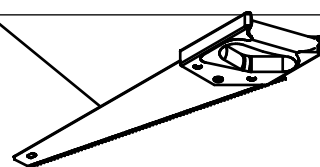

WG11-1 x8

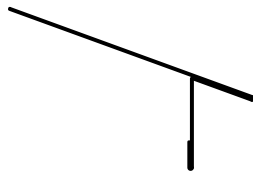

WG11-1

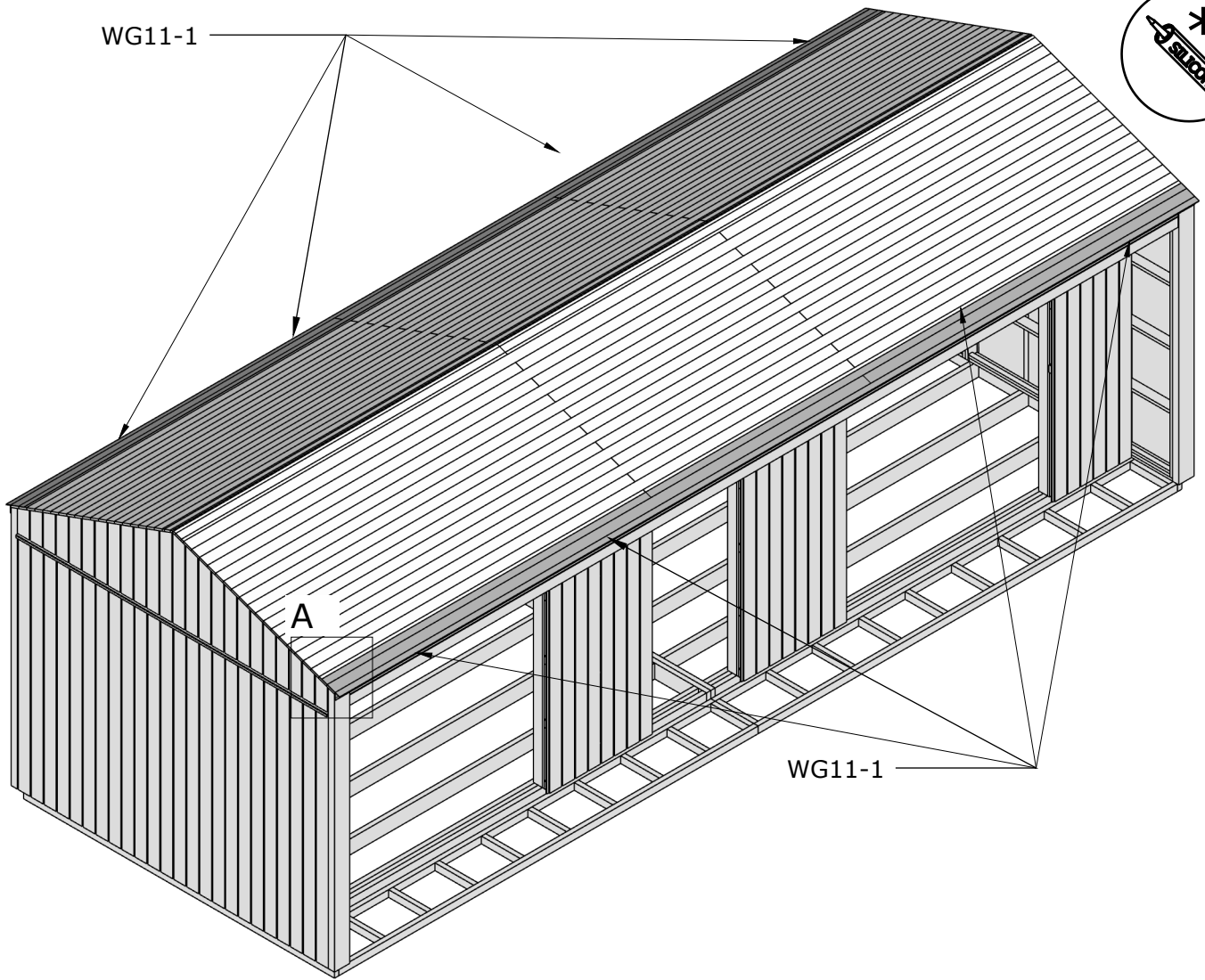

A

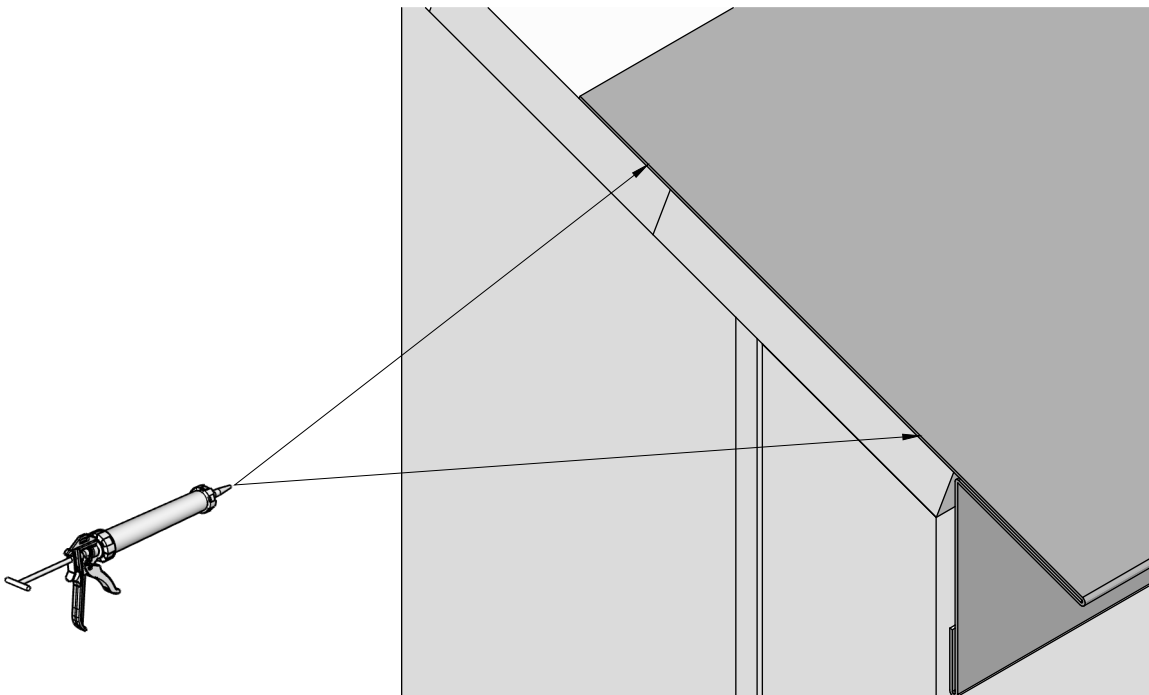

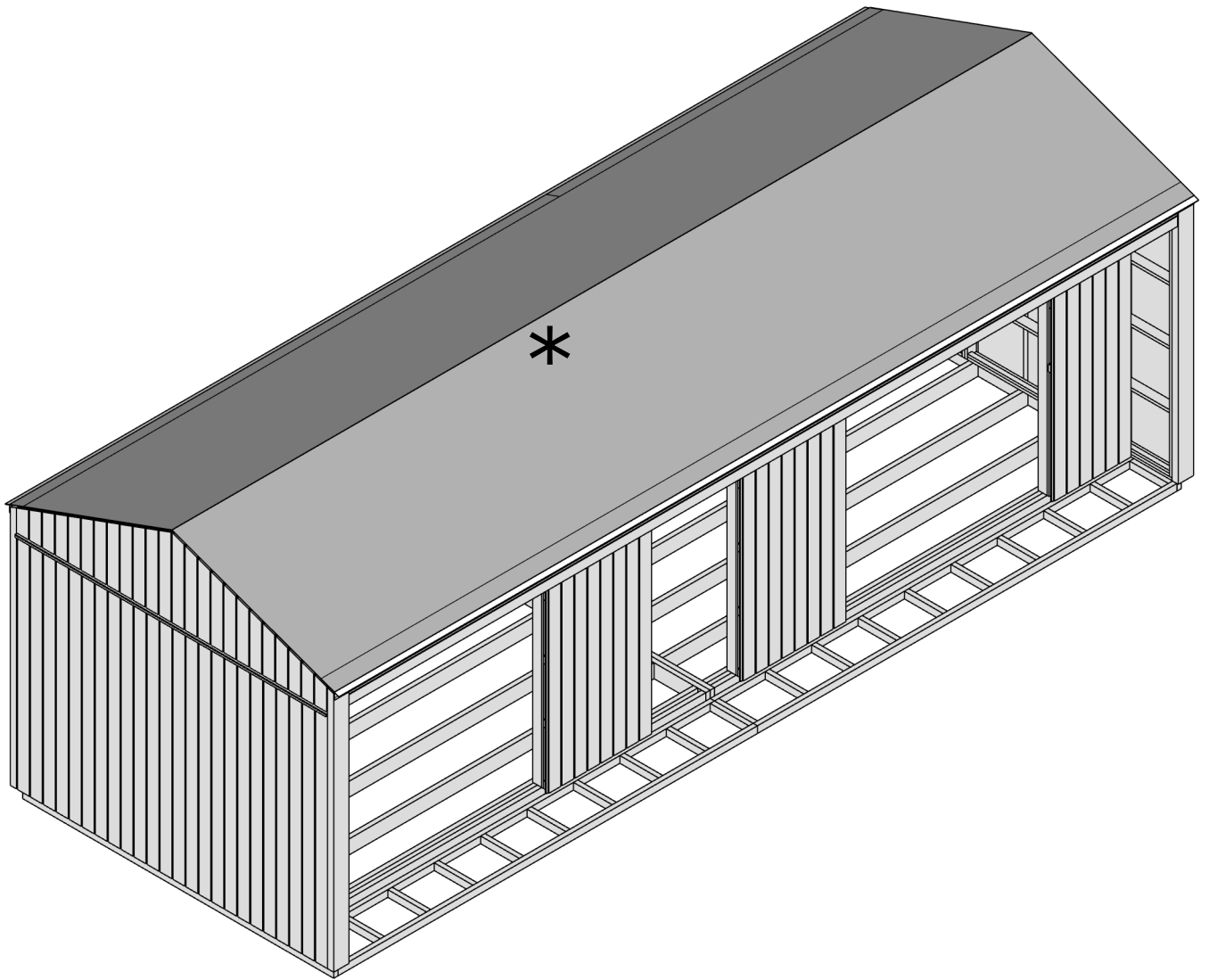

WG12-1 x4



4,8x28 x32



WG12-1



WG12-1

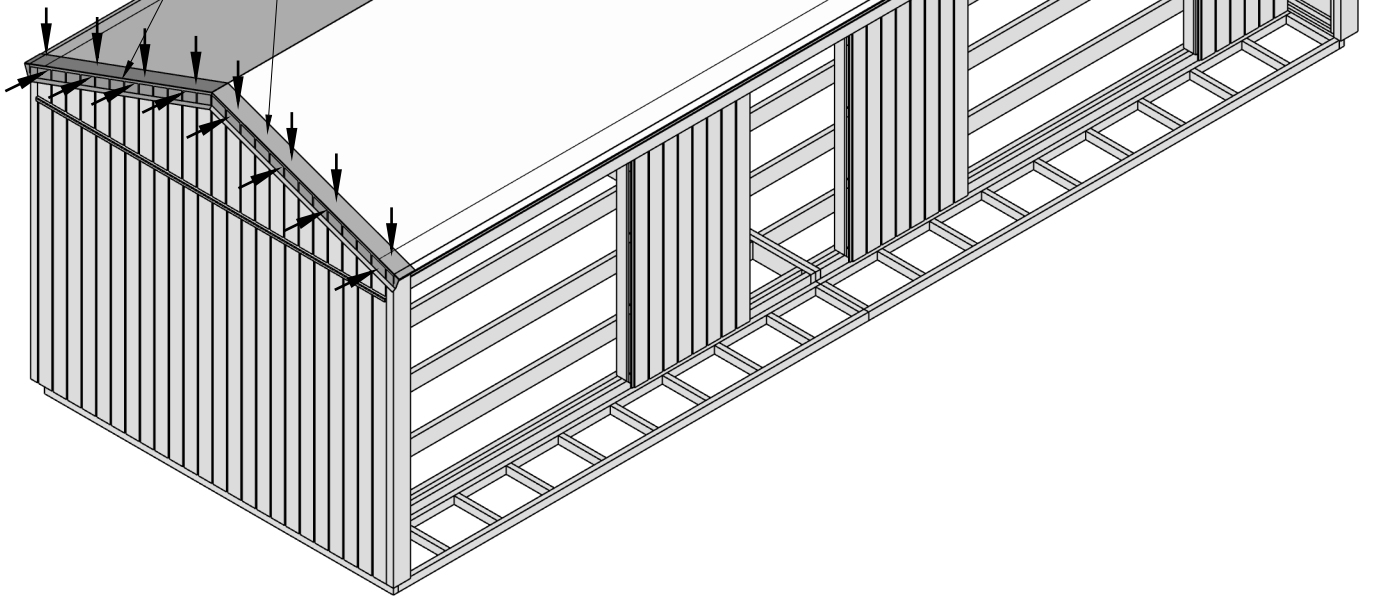

FB2-1 x98

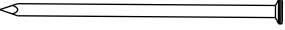
2,5x50 x800 

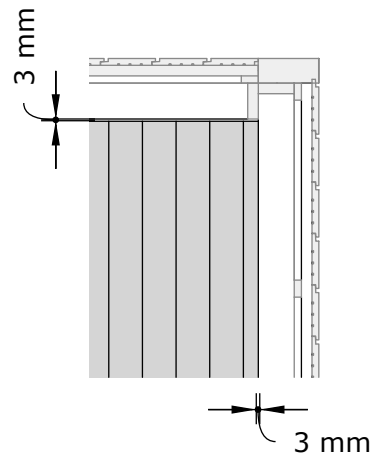
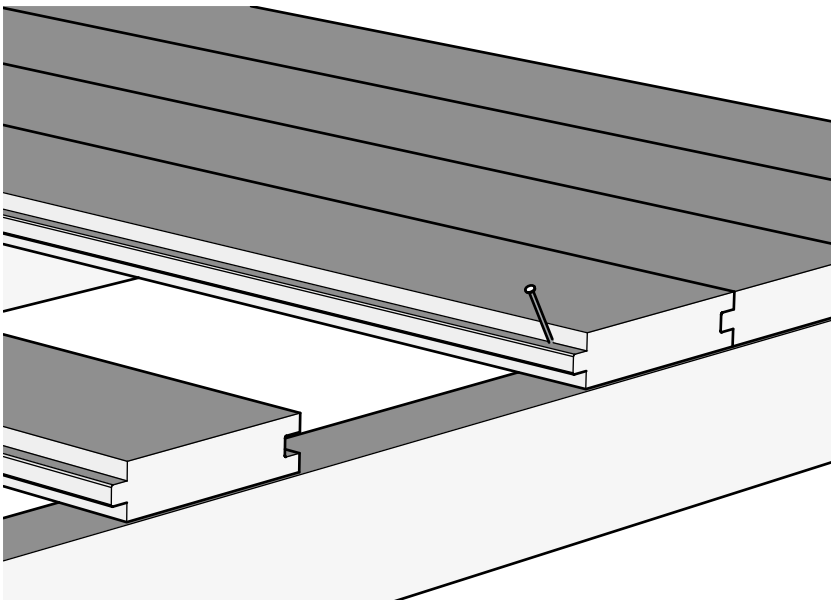
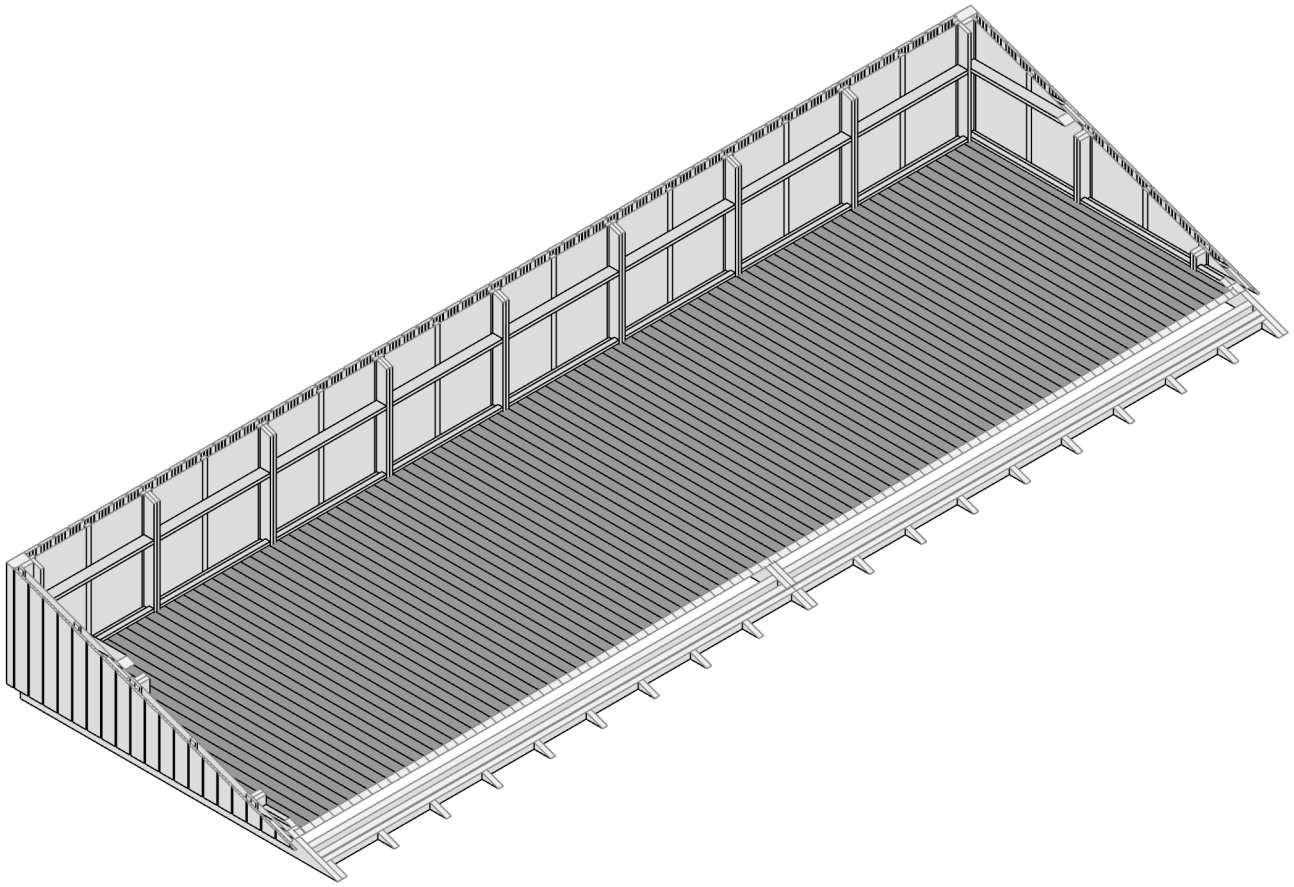
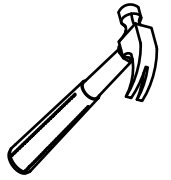

UL4 x2
UL5 x1

2,5x50 x10

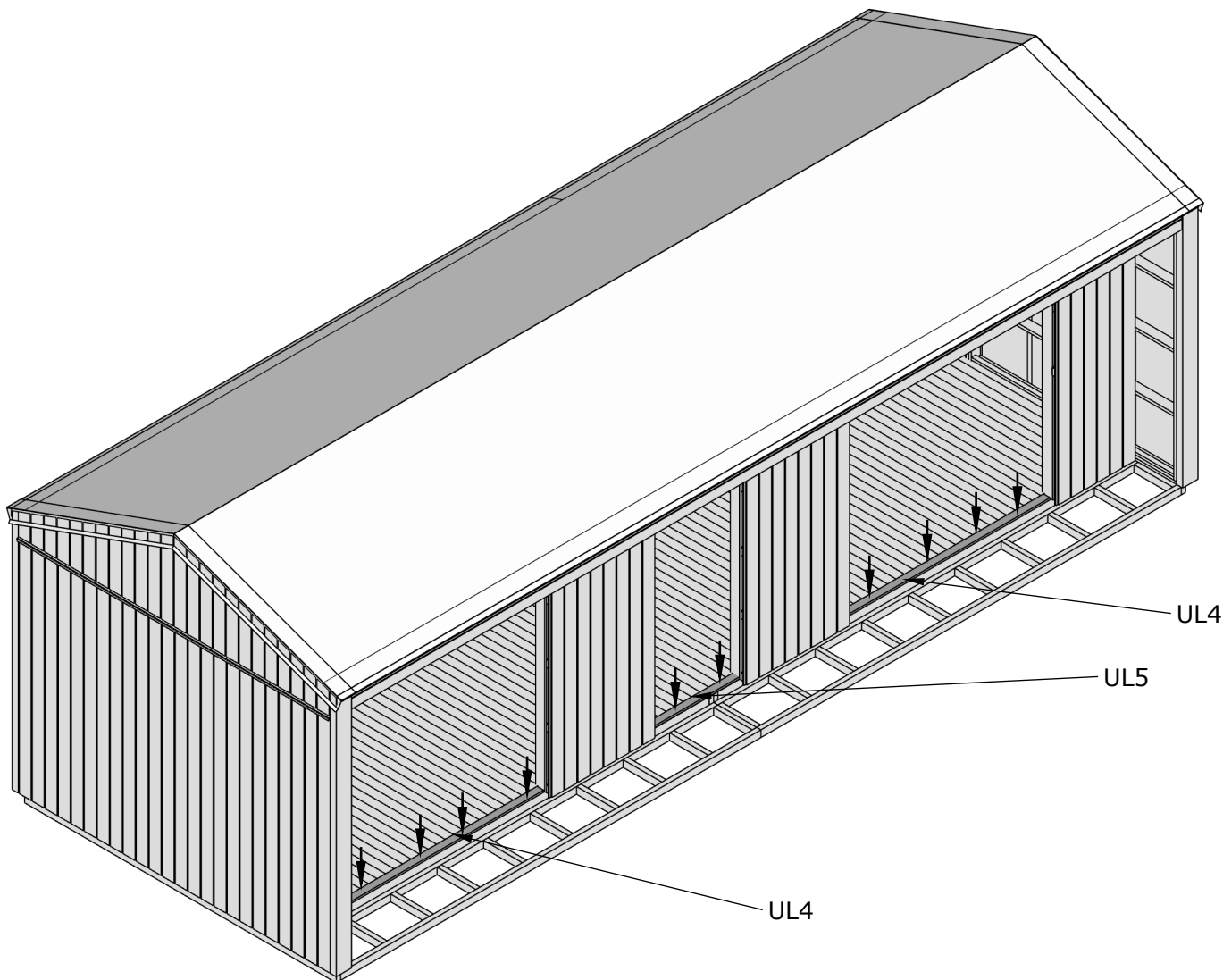
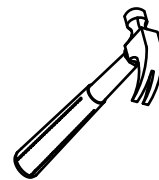
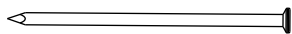

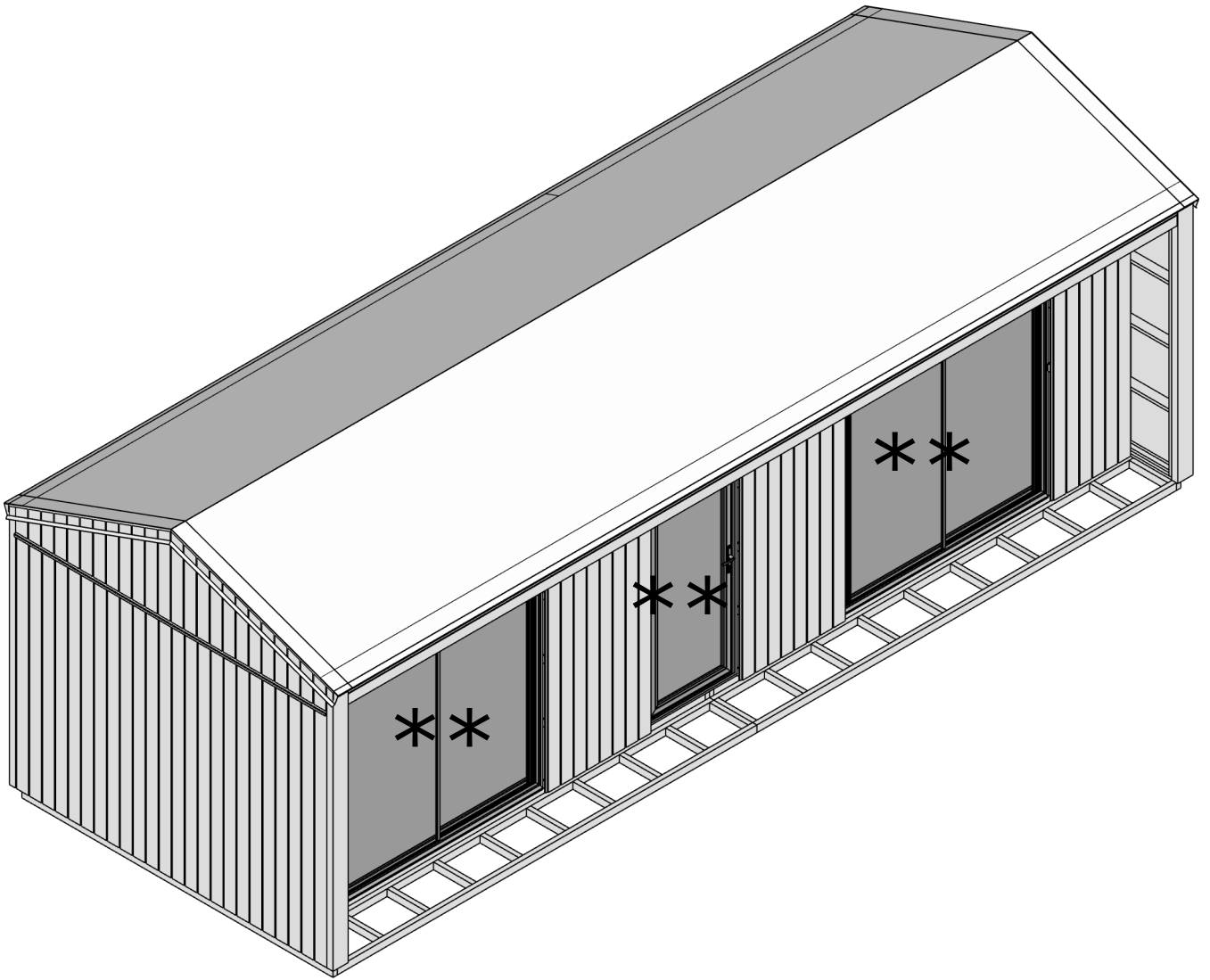

TB2-1 x5

TB2-2 x5

4,5x60 x200

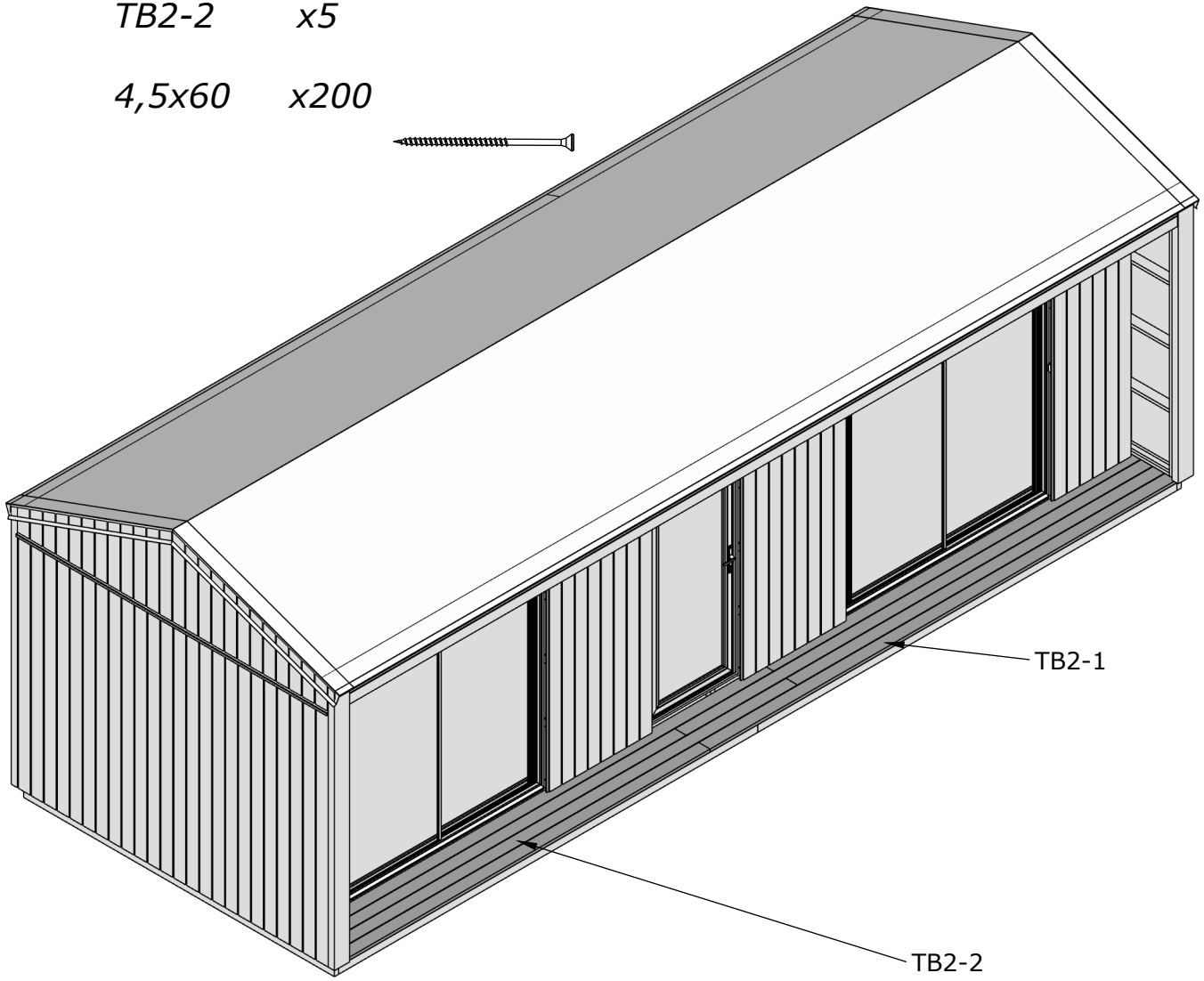
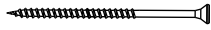

TB2-1

TB2-2

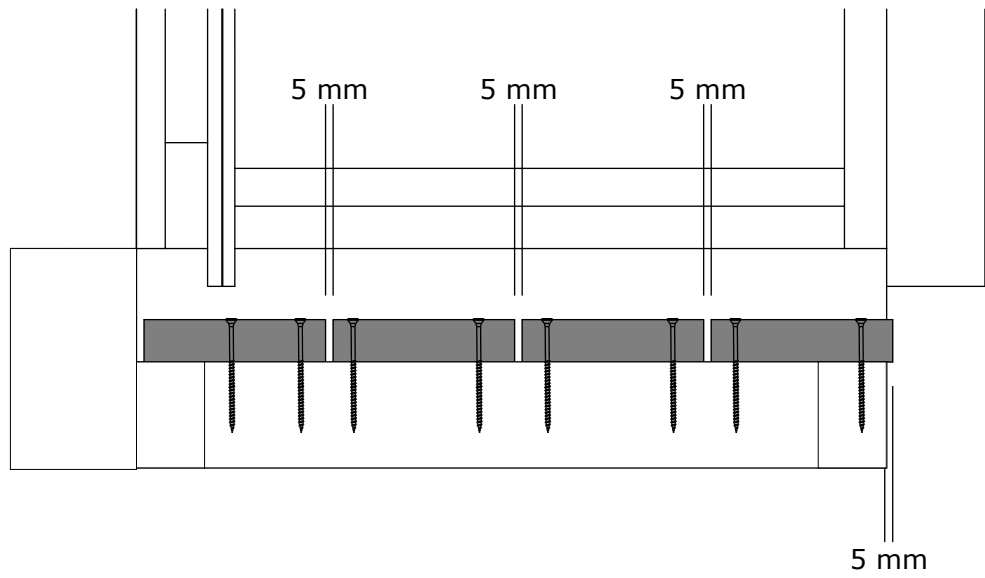

5 mm

5 mm

5 mm

5 mm

FB5-5 x10

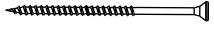
4,5x60 x100 

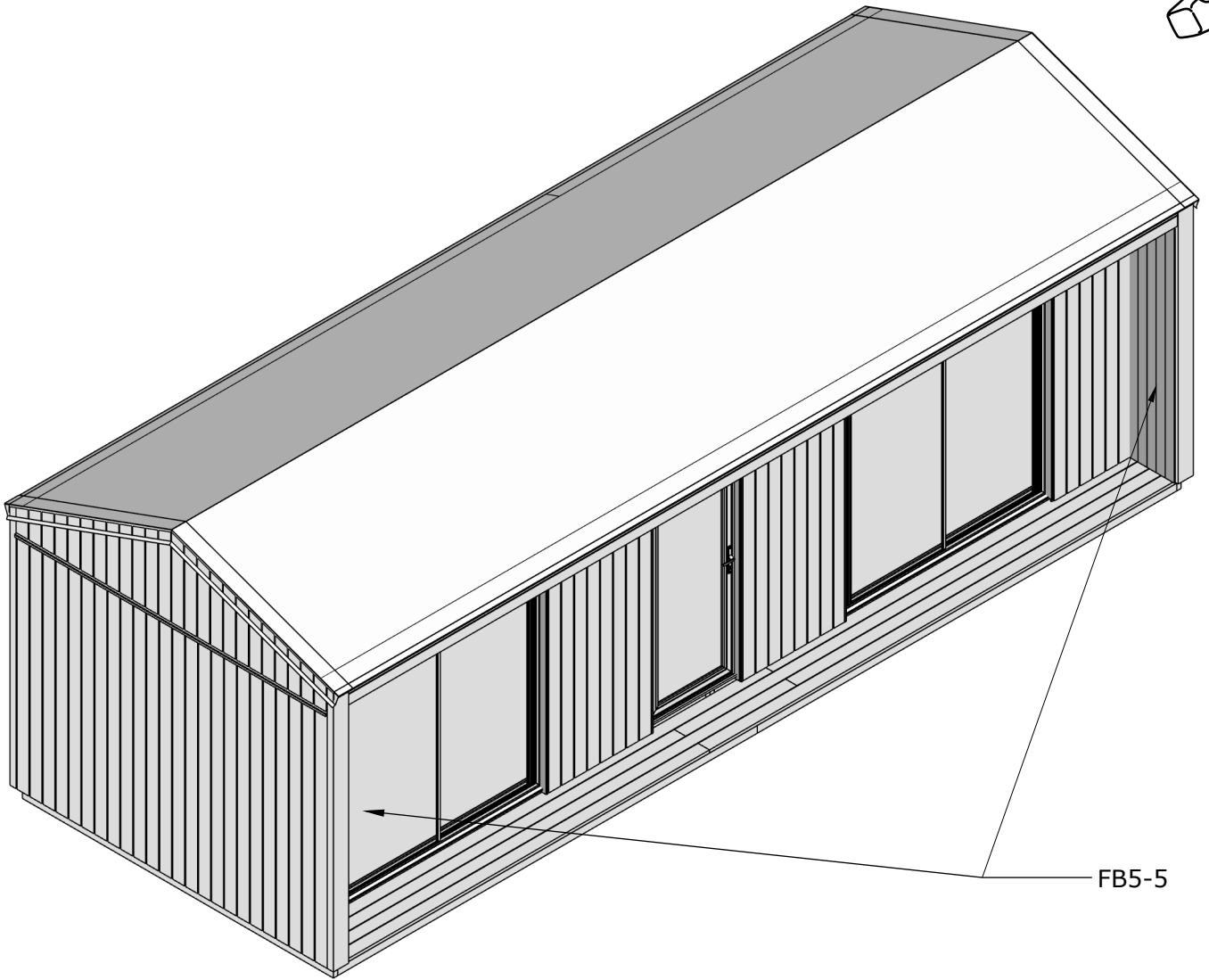
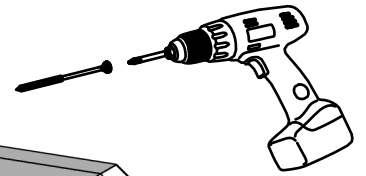

FB5-5

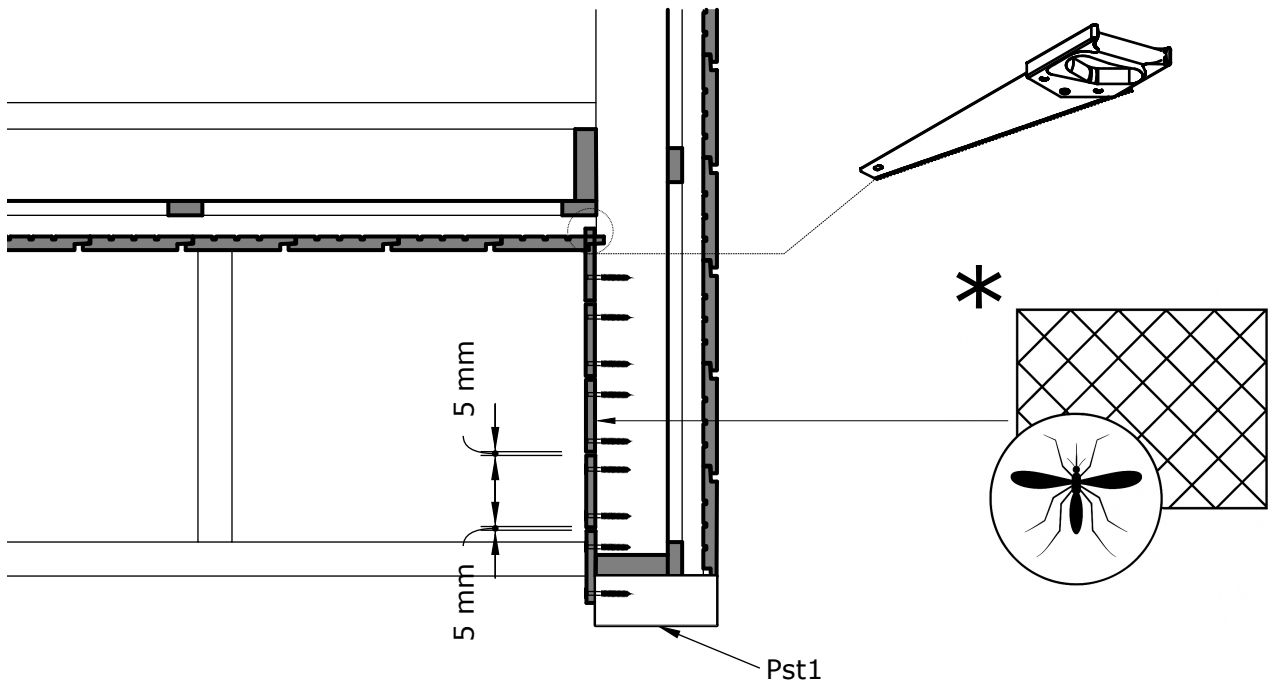

UL1 x4

UL2 x1

UL3 x1

4,5x60 x22

