

# Technische Daten



Spiegelverkehrte Montage möglich

**Artikelnummer: 613 057**

Besteht aus: 612 050 (Seite 2) und 813 020 (Seite 12)

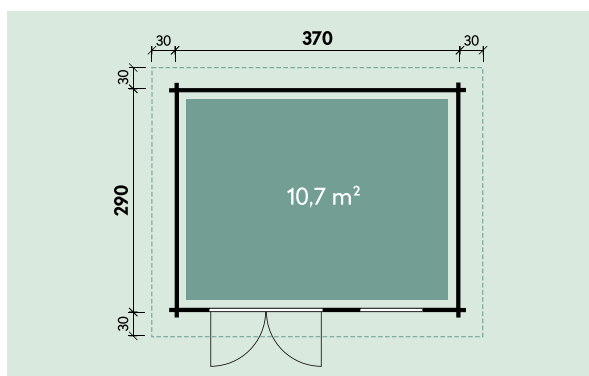

Kontrolliert durch:

# Technische Daten



Spiegelverkehrte Montage möglich

## Artikelnummer:

612 050

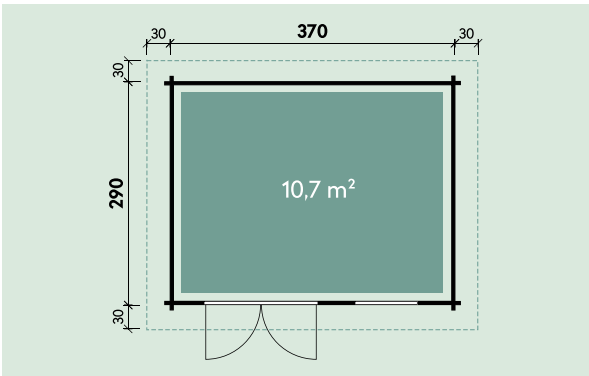

Kontrolliert durch:

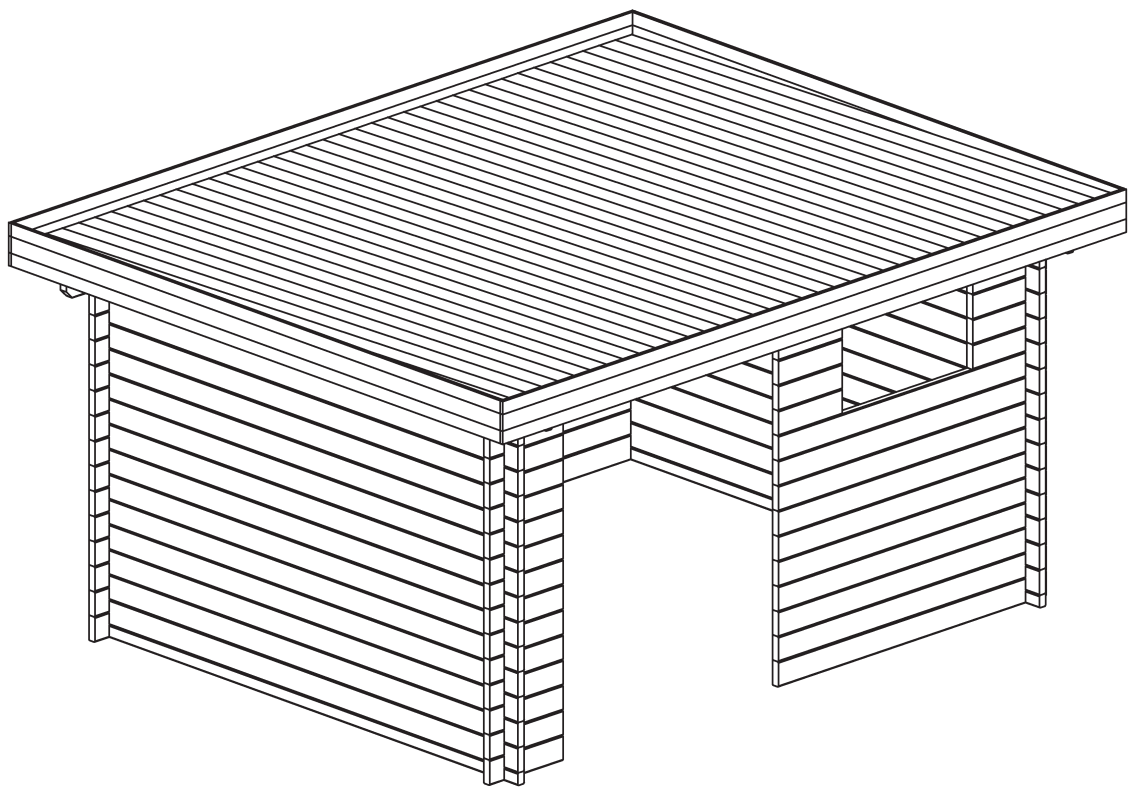

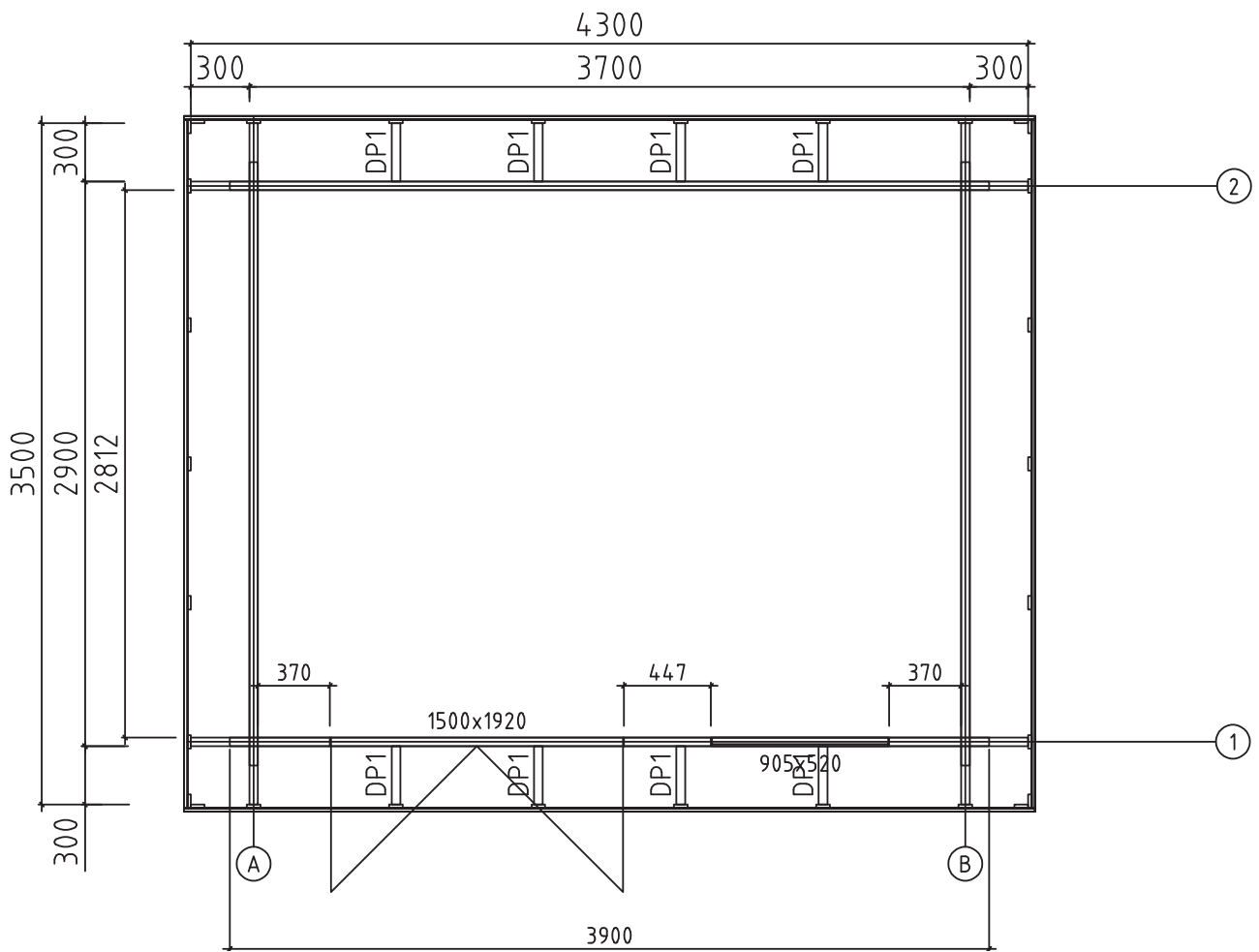

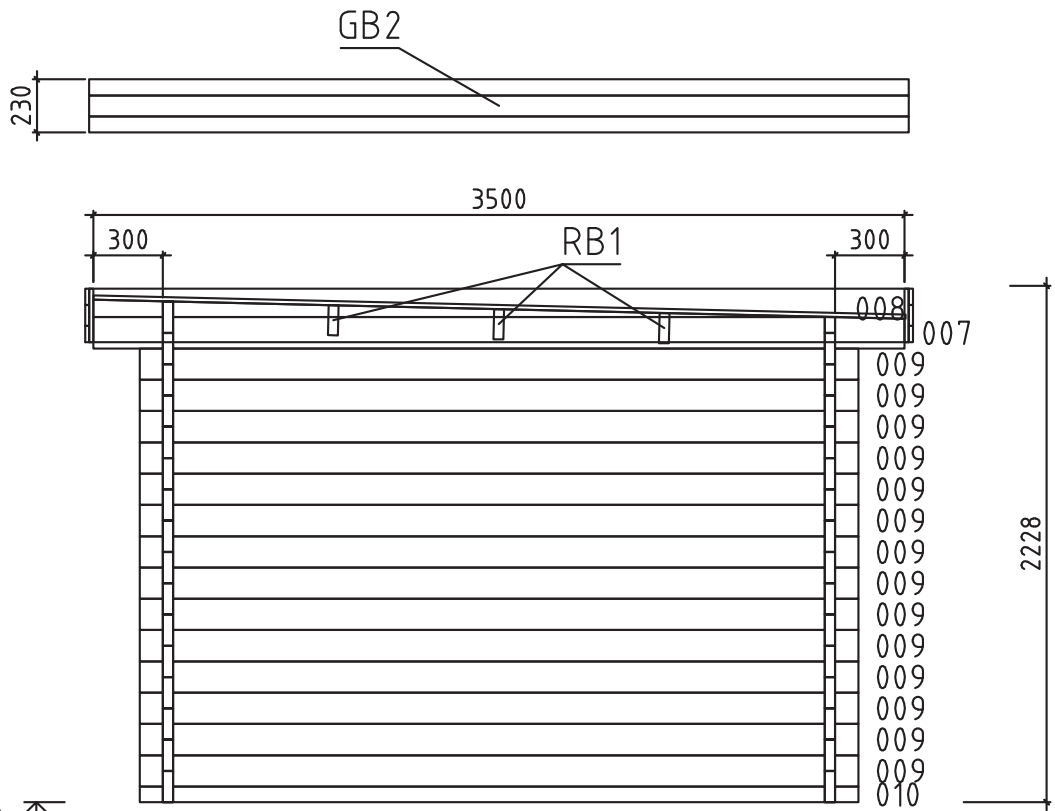
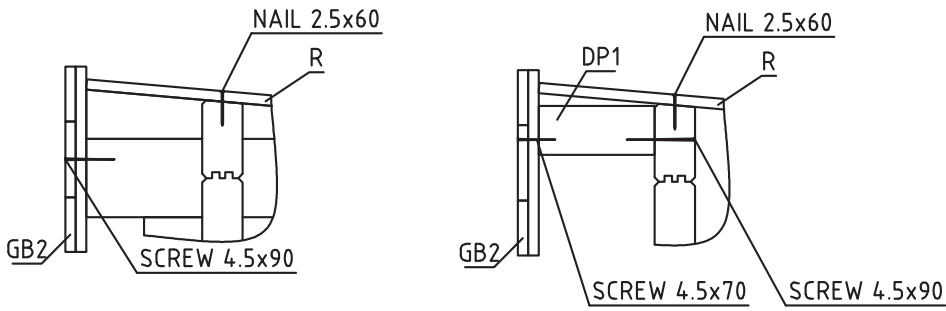



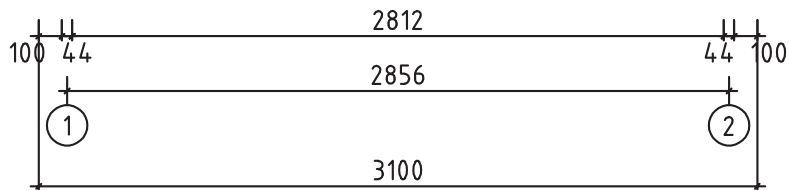

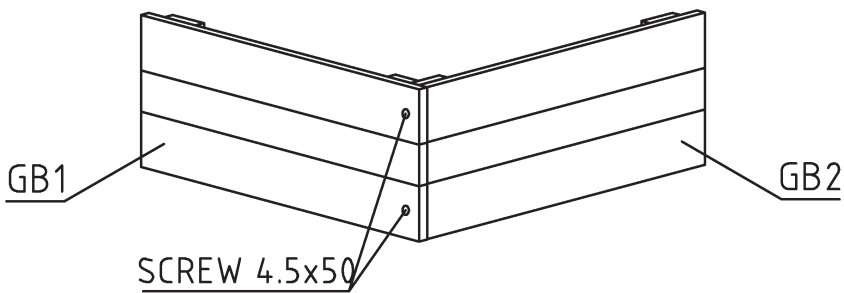
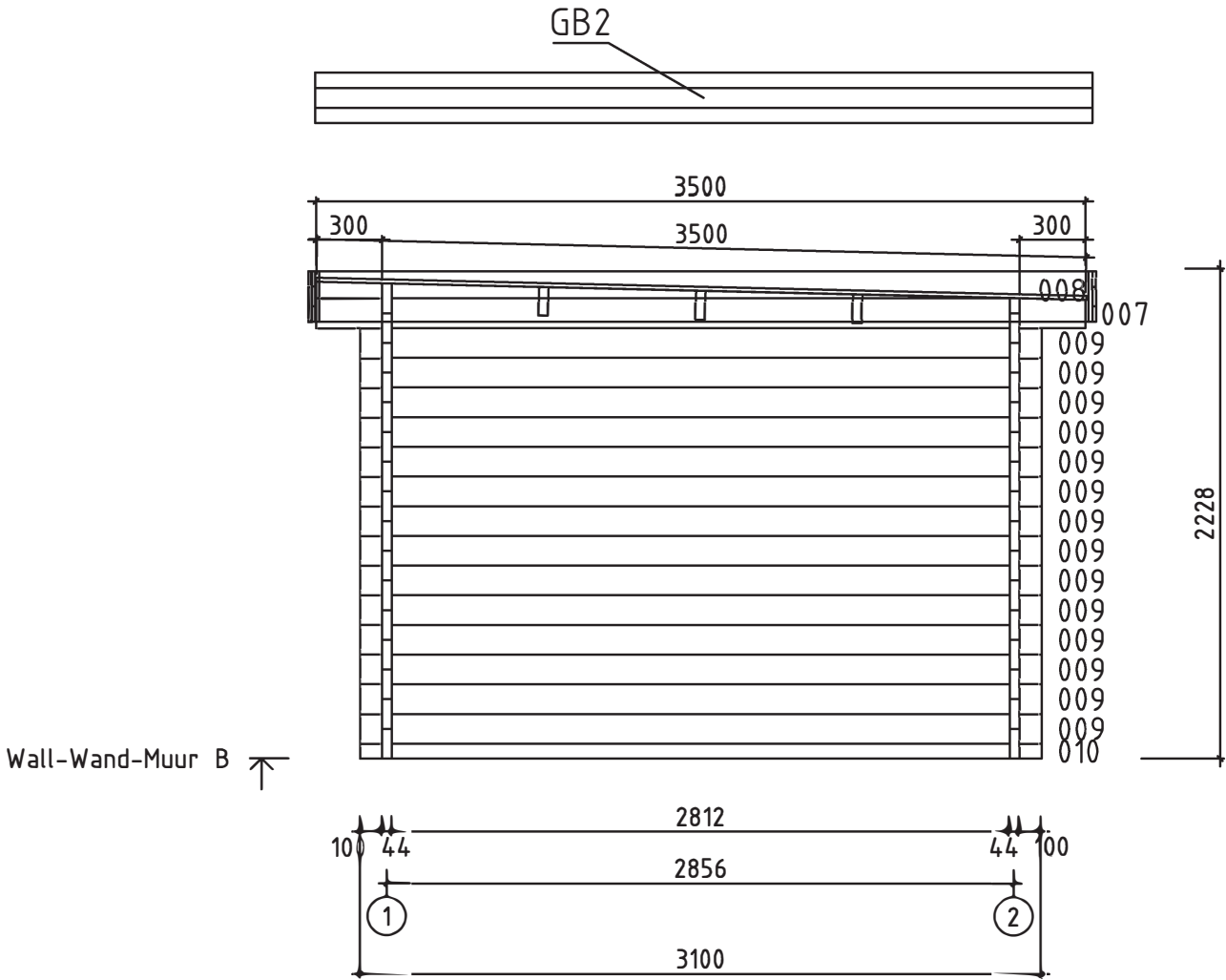



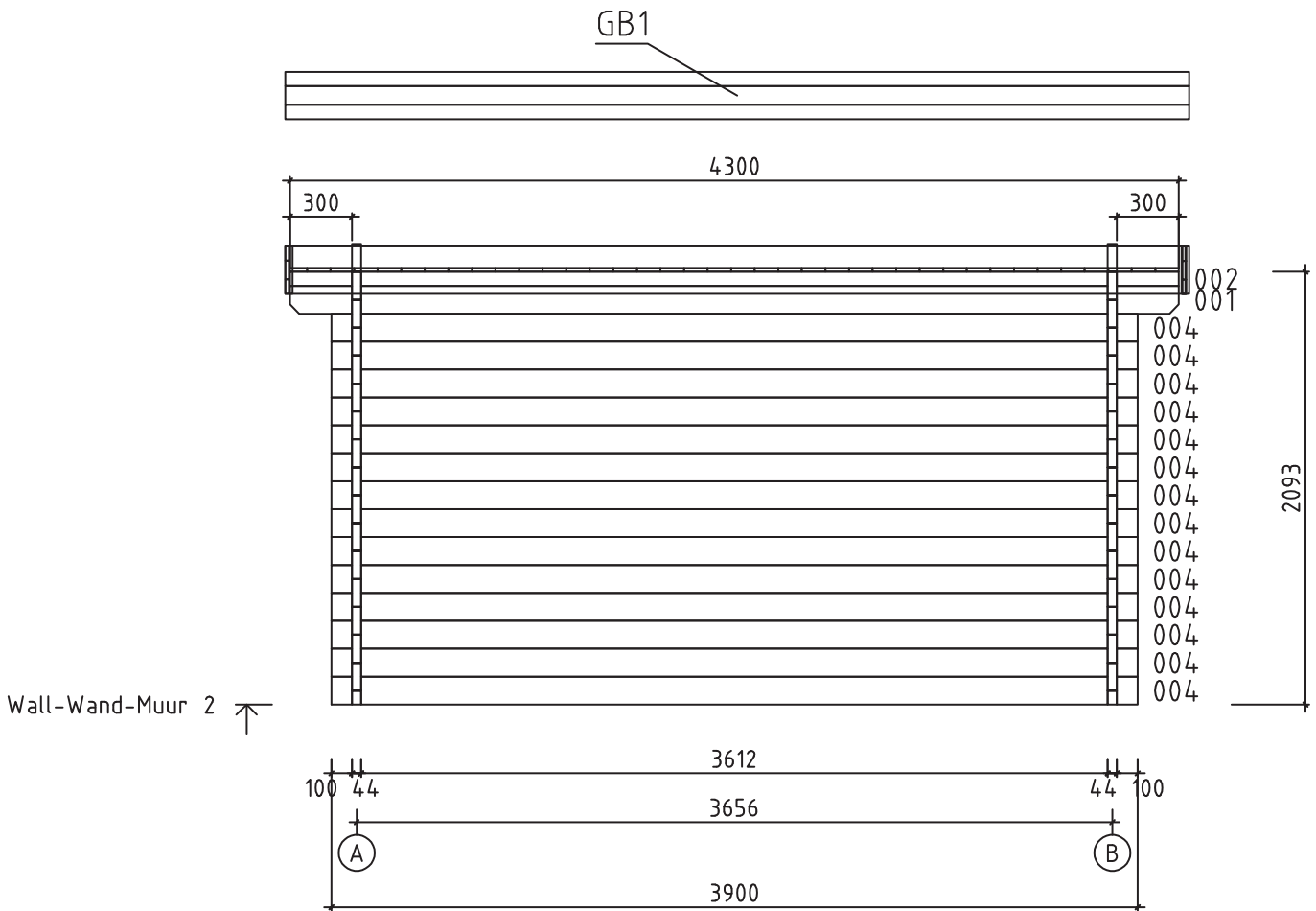

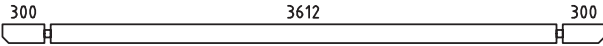
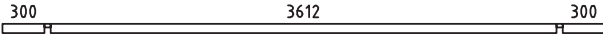
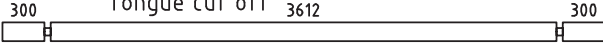
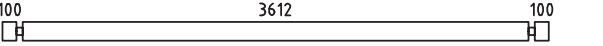
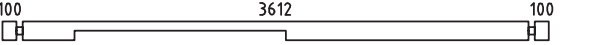
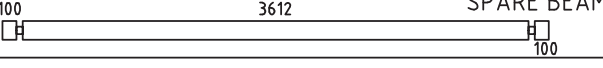
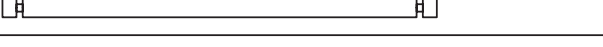
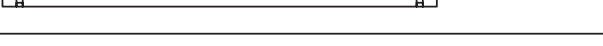
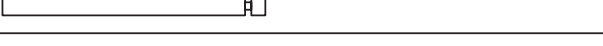



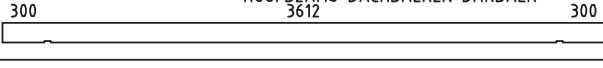

Wall-Wand-Muur A ↗

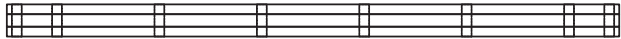





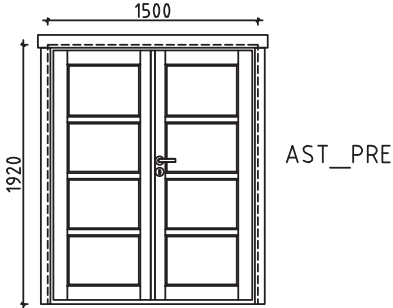
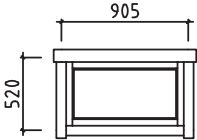

Pos	Specification-Bestimmung-Omschrijving	Pcs	Profile (mm)	L (mm)
001	 300 3612 300	1	44x135	4300
002	 300 3612 300	1	44x68	4300
003	 300 tongue cut off 3612 300	PM 1	44x135	4300
004	 100 3612 100	14	44x135	3900
005	 100 3612 100	1	44x135	3900
006	 100 3612 SPARE BEAM-ERZATZBOHLE 100	1	44x135	3900
009	 100 2812 100	28	44x135	3100
010	 100 2812 100	2	44x68	3100
011	 1732 100	10	44x135	1876
012	 100 370	18	44x135	514
013		4	44x135	447
WA-1	 211 0.08 3500 007	1	44x211	3500
WB-1	 211 0.08 3500 007	1	44x211	3500
HB	HIT BLOCK-SCHLAGHÖLZER-BLAZENPLANK 	2	44x135	300
RB1	 300 ROOFBEAMS-DACHBALKEN-DAKBALK 3612 300	3	43x140	4300
R1	ROOFBOARD-DACHBRETT-DAKPLANK  or-oder-of	38+1 50+1	114x18 88x18	3500
GB1	ASSEMBLY REQUIRED-MONTAGE ERFORDERLICH-MONTAGE VEREIST 	2	36x230	4372
GB2	ASSEMBLY REQUIRED-MONTAGE ERFORDERLICH-MONTAGE VEREIST 	2	36x230	3536
DP1	FIXING SLAT-BEFESTIGUNGSLEISTE-BEVESTIGING PLINT 	8	45x90	300
	NAIL-NAGEL-NAGEL FOR-FÜR-VOOR R1 	300	∅2.5	60
	SCREWS-SCHRAUBEN-SCHROEF FOR-FÜR-VOOR GB1, GB2 	20	∅4.5	50
	SCREWS-SCHRAUBEN-SCHROEF FOR-FÜR-VOOR GB1, GB2 	25	∅4.5	70
	SCREWS-SCHRAUBEN-SCHROEF FOR-FÜR-VOOR 8xDP1 	150	∅4.5	90
	SCREWS-SCHRAUBEN-SCHROEF FOR-FÜR-VOOR RB1 	6	∅6.0	160

Pos	Specification-Bestimmung-Omschrijving	Pcs.	Profil (mm)	L (mm)
	<p>DOUBLEDOOR-DOPPELTÜR-DUBBELE DEUR (right-rechts-rechts) P.P.</p> 	1	1500	1920
	<p>WINDOW-FENSTER-VENSTER (left-links-gauche) AST_PRE</p> 	1	905	520

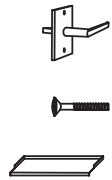
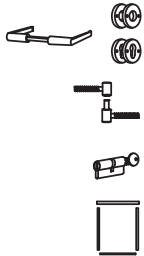

## Doppeltür 1500 x 1920

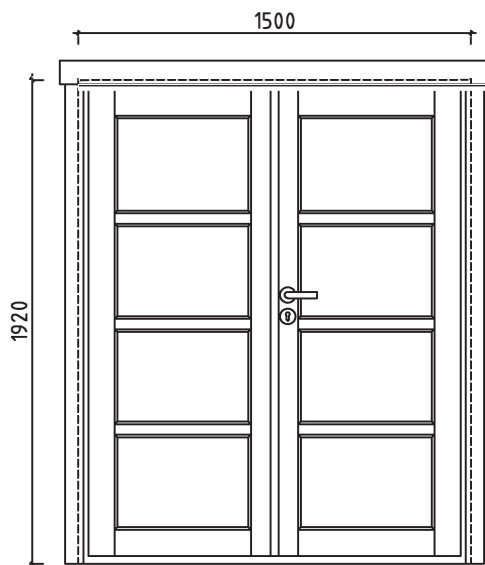

- Breite 46 mm Begrenzungsleisten auf beiden Seiten (an den Seiten 18x70, oben 18x90)
- Seitliche Begrenzungsleisten innen 19 mm von der Unterkante der Breite
- Unterkante der Breite
- Milchglas
- Mantel
- Dichtung
- 3D-Polsterscharniere
- Abschließbar
- Windleiste nach außen
- Eingelassene Leiste

## Fenster 905 x 520

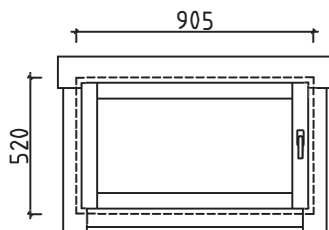

- Breite 46 mm Begrenzungsbretter auf beiden Seiten (seitlich und unten 18 x 70, oben 18 x 90)
- Öffnet sich nach innen
- Mantel
- Dichtung
- Drehbar
- Mit Riegel verschließbar
- Aluminiumleiste + Wasserblech
- Milchglas

# Technische Daten



**Artikelnummer:**

813 020

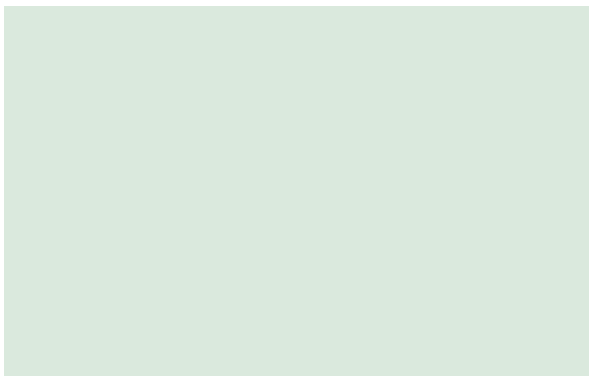

**Kontrolliert durch:**

**Wir empfehlen als Fundament für Ihr Gartenhaus eine vollflächig festgegründete, gepflasterte oder betonierte Fläche. Wahlweise ist auch ein Punkt- oder Streifenfundament möglich.**

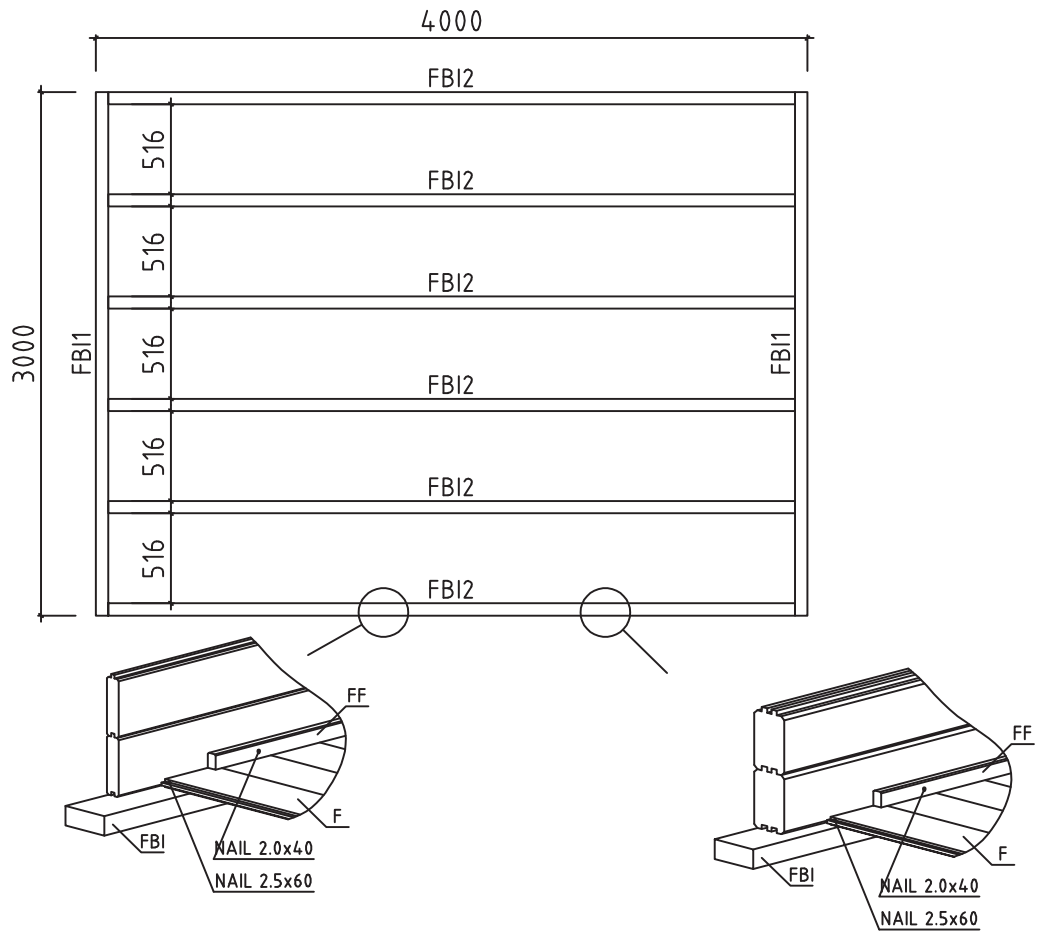

28mm WAND

44mm WAND

