

EINBAUANLEITUNG

„Zwischenboden“

HochBeet 2x1m & 1,5x1m

- Ⓜ GB Assembly instructions “intermediate floor” for Raised Vegetable Bed 2x1 & 1,5x1
- Ⓜ FR Notice de montage “sol intermédiaire” pour potager surélevé 2x1 & 1,5x1
- Ⓜ NL Opbouwbeschrijving “tussenbodem” voor MoestuinBox 2x1 & 1,5x1
- Ⓜ ES Instrucciones de montaje “estante intermedio” para Huerto Urbano 2x1 & 1,5x1
- Ⓜ IT Istruzioni di montaggio “ripiano intermedio” per Aiuola rialzata 2x1 & 1,5x1
- Ⓜ DK Samvejledning “mellemhylde” for Højbed 2x1 & 1,5x1
- Ⓜ SE Monteringsanvisningar “mellanhylla” för Upphöjd grönsaksbädd 2x1 & 1,5x1
- Ⓜ NO Monteringsanvisning “Mellomhylle” for Høybed 2x1 & 1,5x1
- Ⓜ PL Instrukcja montażu “Półka pośrednia” dla Podwyższonej grządki 2x1 & 1,5x1
- Ⓜ SK Návod na montáž “Medzipodlaha” pre Vysoký záhon 2x1 & 1,5x1
- Ⓜ SI Navodila za montažo »vmesna polica« za Visoka greda 2x1 & 1,5x1
- Ⓜ CZ Návod k montáži “Mezipodlážka” pro Zvýšený truhlík na zeleninu 2x1 & 1,5x1
- Ⓜ HU Összeszerelési útmutató a “Közbenső polc” Magaságyás 2x1 & 1,5x1
- Ⓜ HR Upute za sastavljanje “Umjesna ploča” za Visoka gredica 2x1 & 1,5x1





TEILEÜBERSICHT

Parts list · Liste des pièces · Stuklijst · Lista de piezas · Lista de parti · Deloversigt · Delöversikt · Del liste · Przegląd elementów · Zoznam dielov · Seznam delov · Seznam dílů · Tétélek áttekintése · Popis dijelova · Lista pieselor



1.

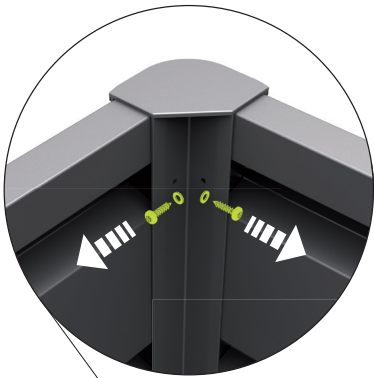

SCHRAUBEN DEMONTIEREN!

- EN Please disassemble the screws!
- FR Démonter les vis!

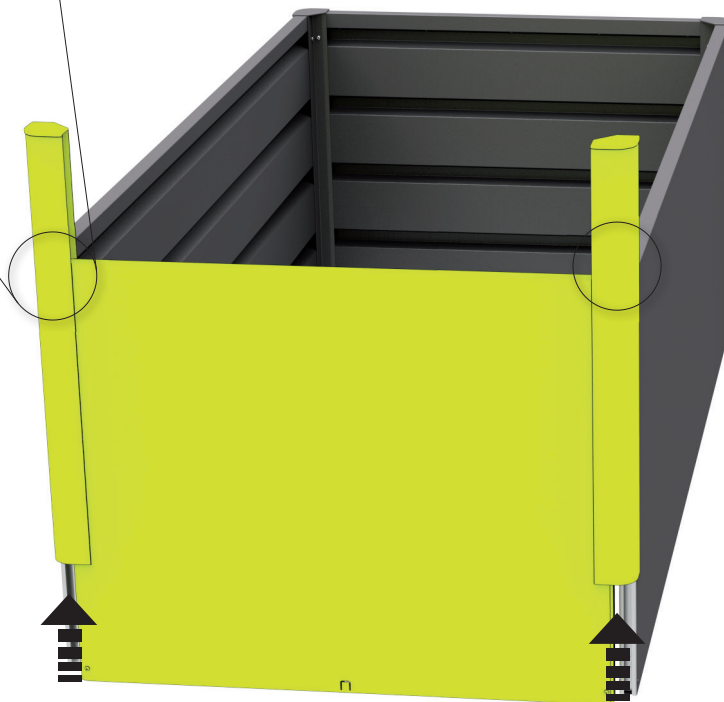

2.

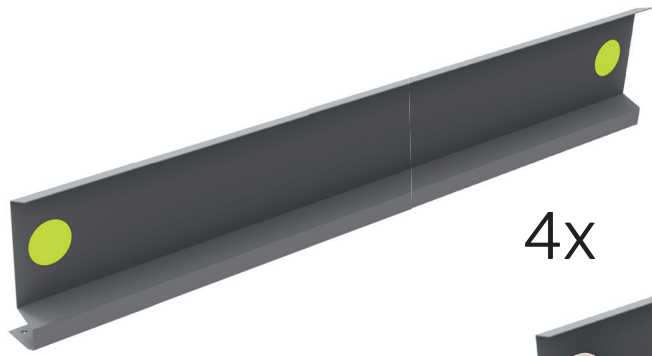

4x

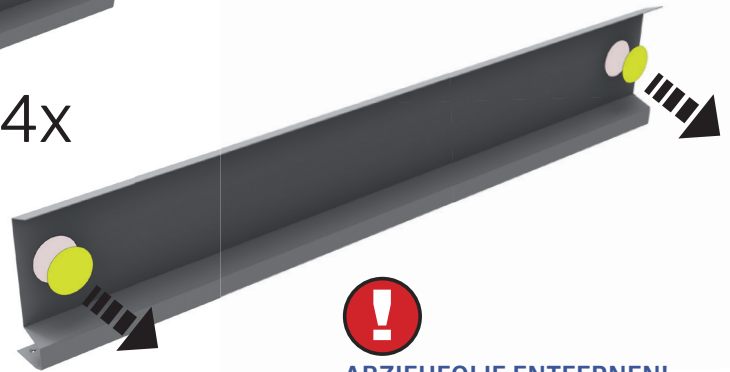

ABZIEHFOLIE ENTFERNEN!

- EN Remove protection foil!
- FR Retirer le film de protection!

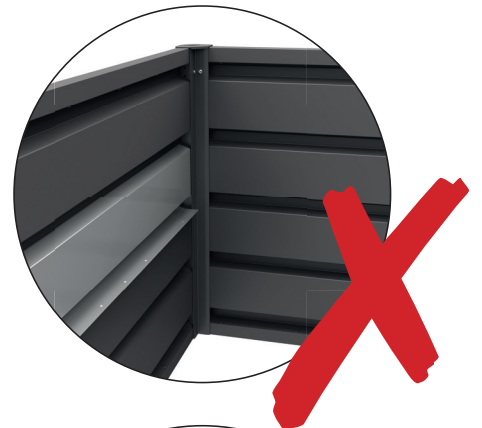
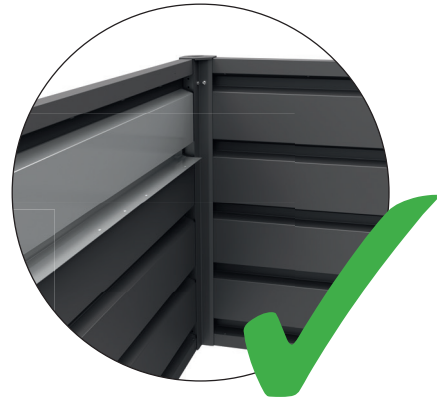
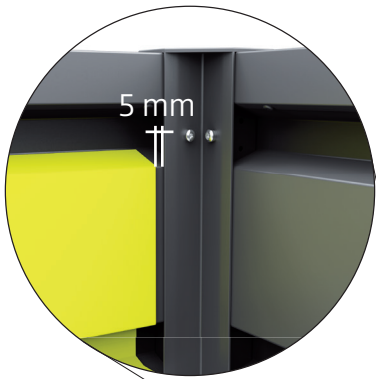

3.



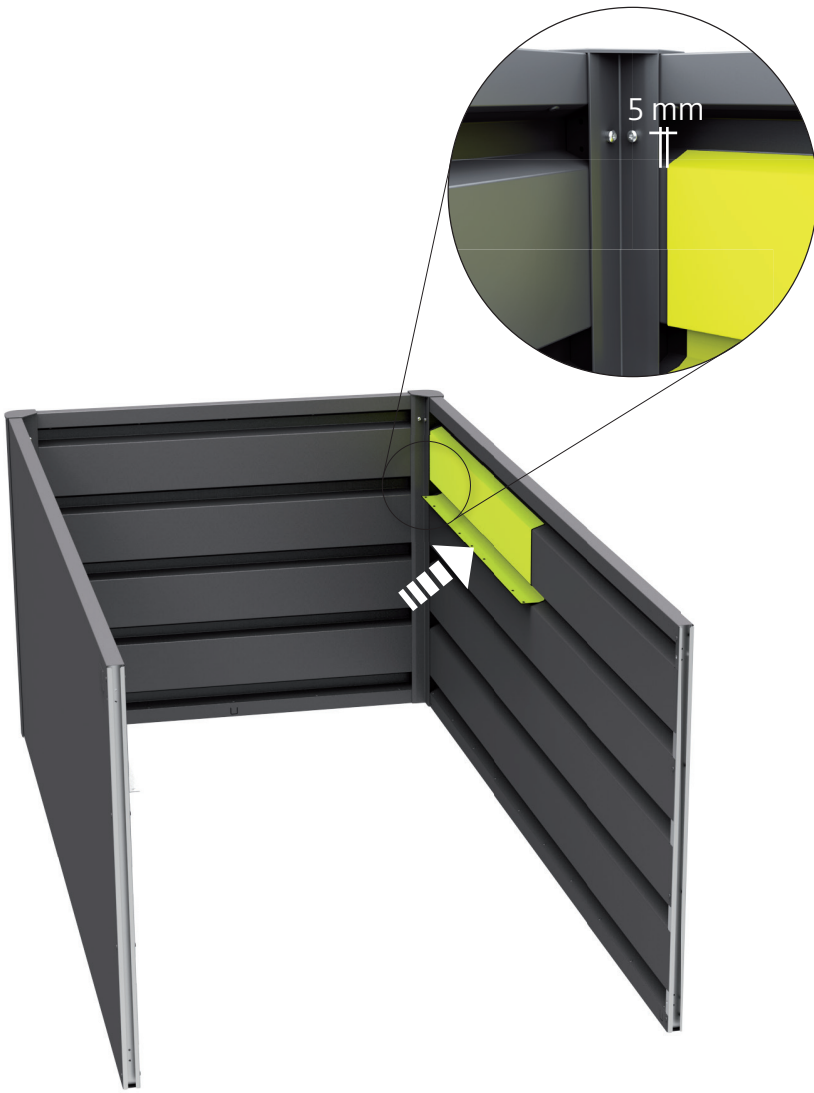

4.

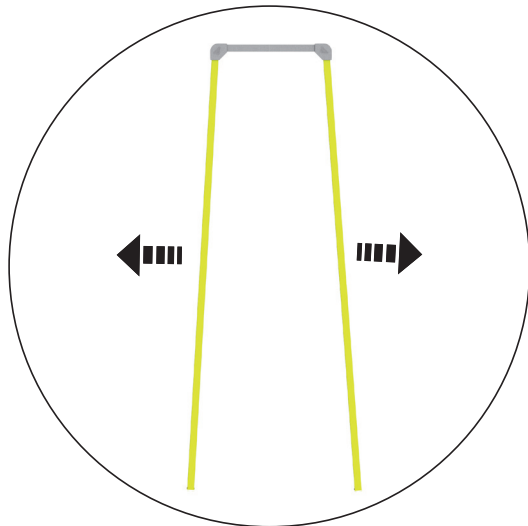

5.

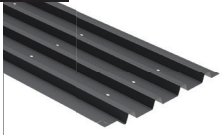

2 x 1: 4x

1,5 x 1: 3x

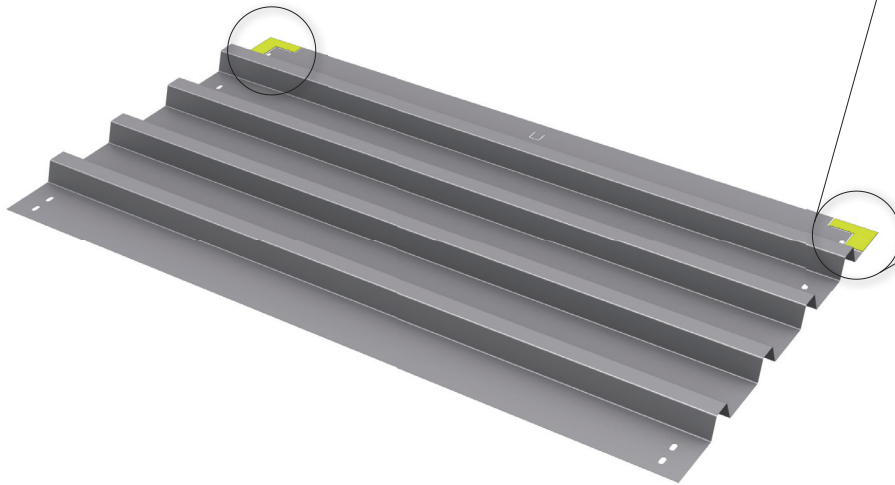

MIT FARBSEITE NACH OBEN MONTIEREN!

- Ⓔ**N** Assemble with color side up!
- Ⓔ**R** Montez avec la face colorée vers le haut!
- Ⓔ**NL** Monteer met de kleurezijde naar boven!
- Ⓔ**ES** Montar con el lado de color hacia arriba!
- Ⓔ**IT** Montare con il colore rivolto verso l'alto!
- Ⓔ**DA** Monteres med lakeret side oppe!

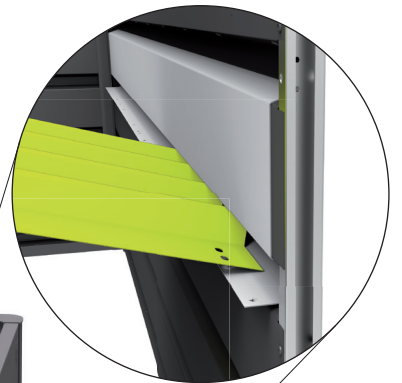

6.



7.

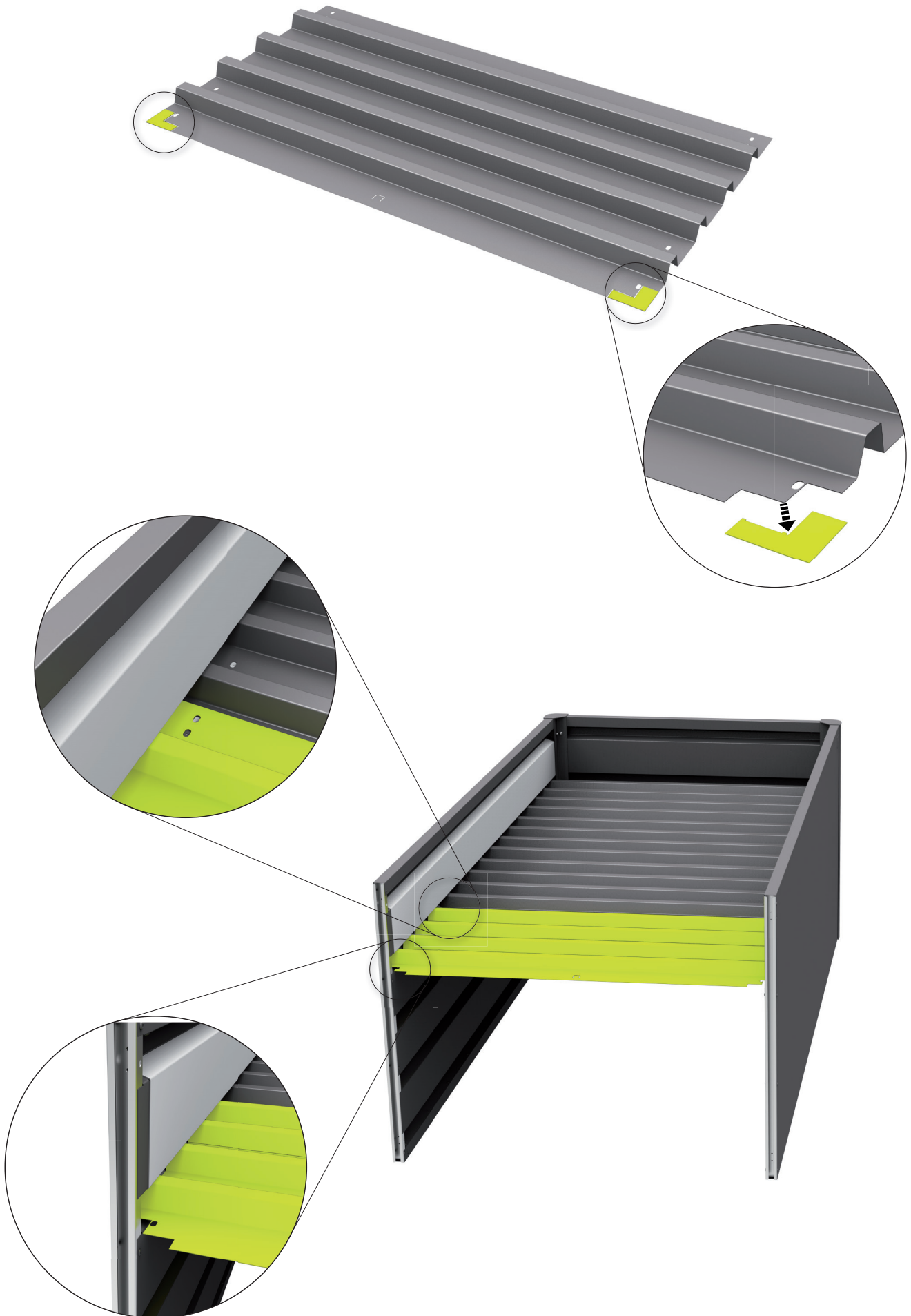

8.

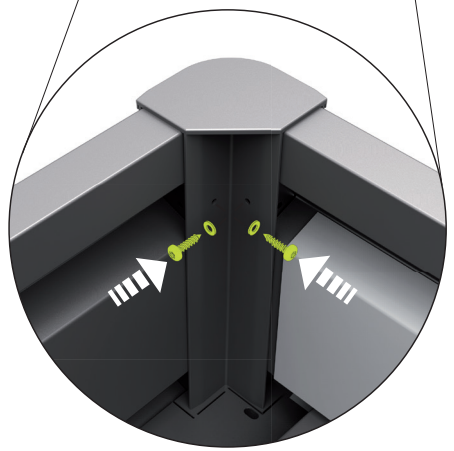
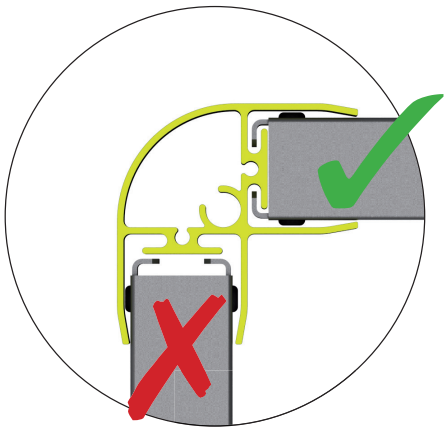

9.

4,8 x 9,5



2 x 1: 16x

1,5 x 1: 12x

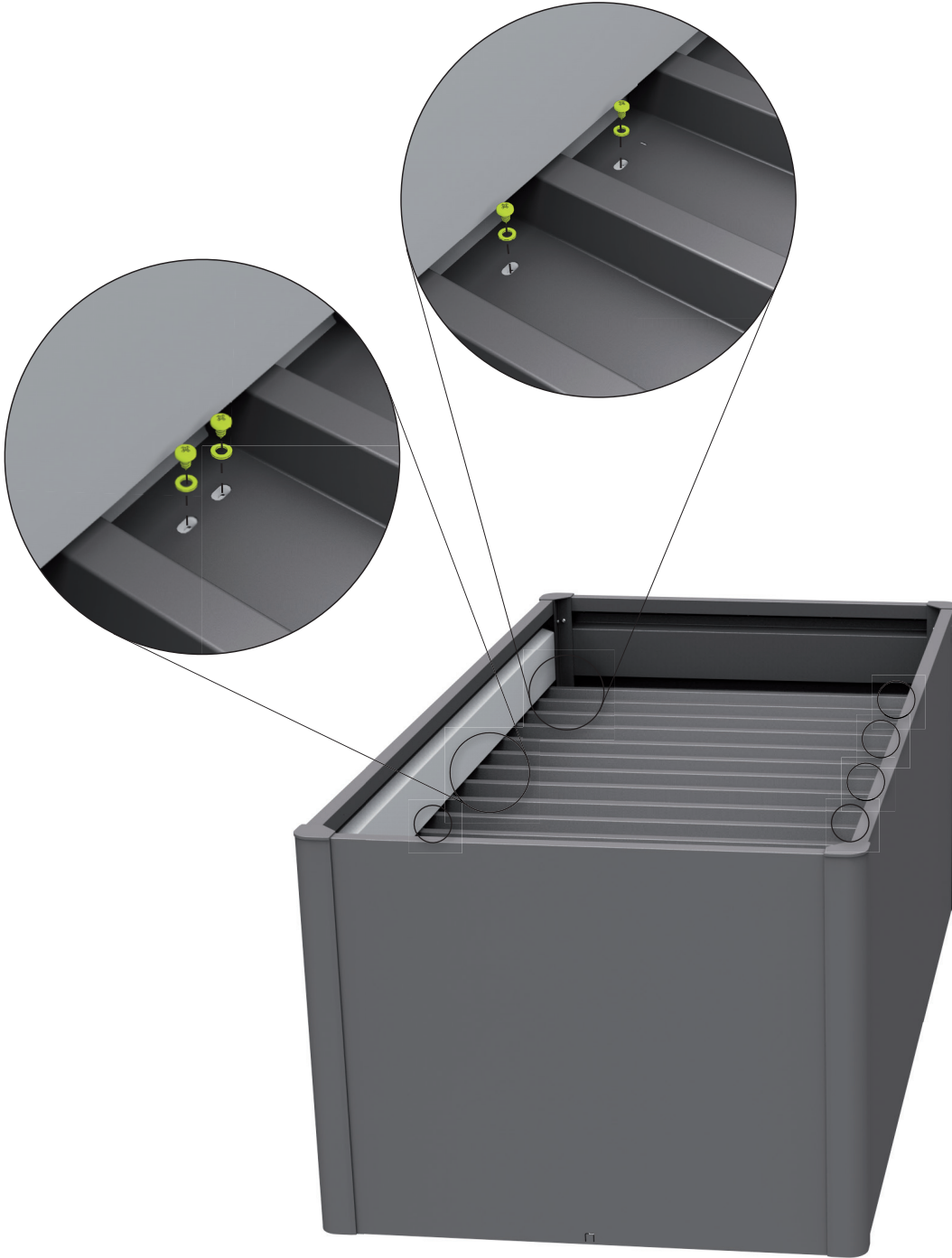

follow us:

- 📷 biohort
- 📘 biohort
- 📺 Biohort GmbH
- 📌 Biohort GmbH



Gerätehäuser
Garden Sheds



Geräteschränke
Outdoor Lockers



Gartenboxen & Multitalente
Outdoor Boxes & Multi-Functional Storage



Outdoor Living
Outdoor Living



Gewächshäuser
Greenhouses



Pflanzbeete
Planting Beds



Gartenhelfer
Gardening Helpers



Adresses sur quefairedemesdechets.fr

Biohort GmbH
PürNSTein 43, 4120
Neufelden, Österreich
+43 7282 / 7788 0
office@biohort.at
www.biohort.com