

Technische Daten

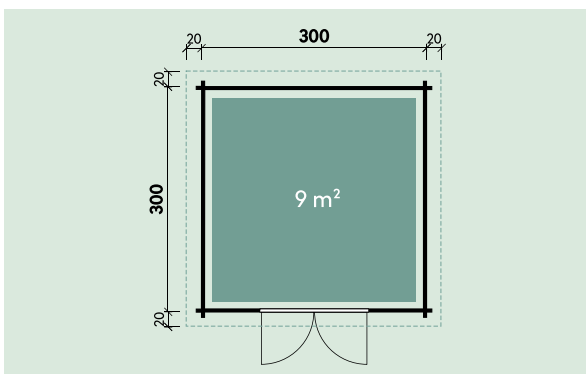

Artikelnummer:

534 381



Kontrolliert durch:

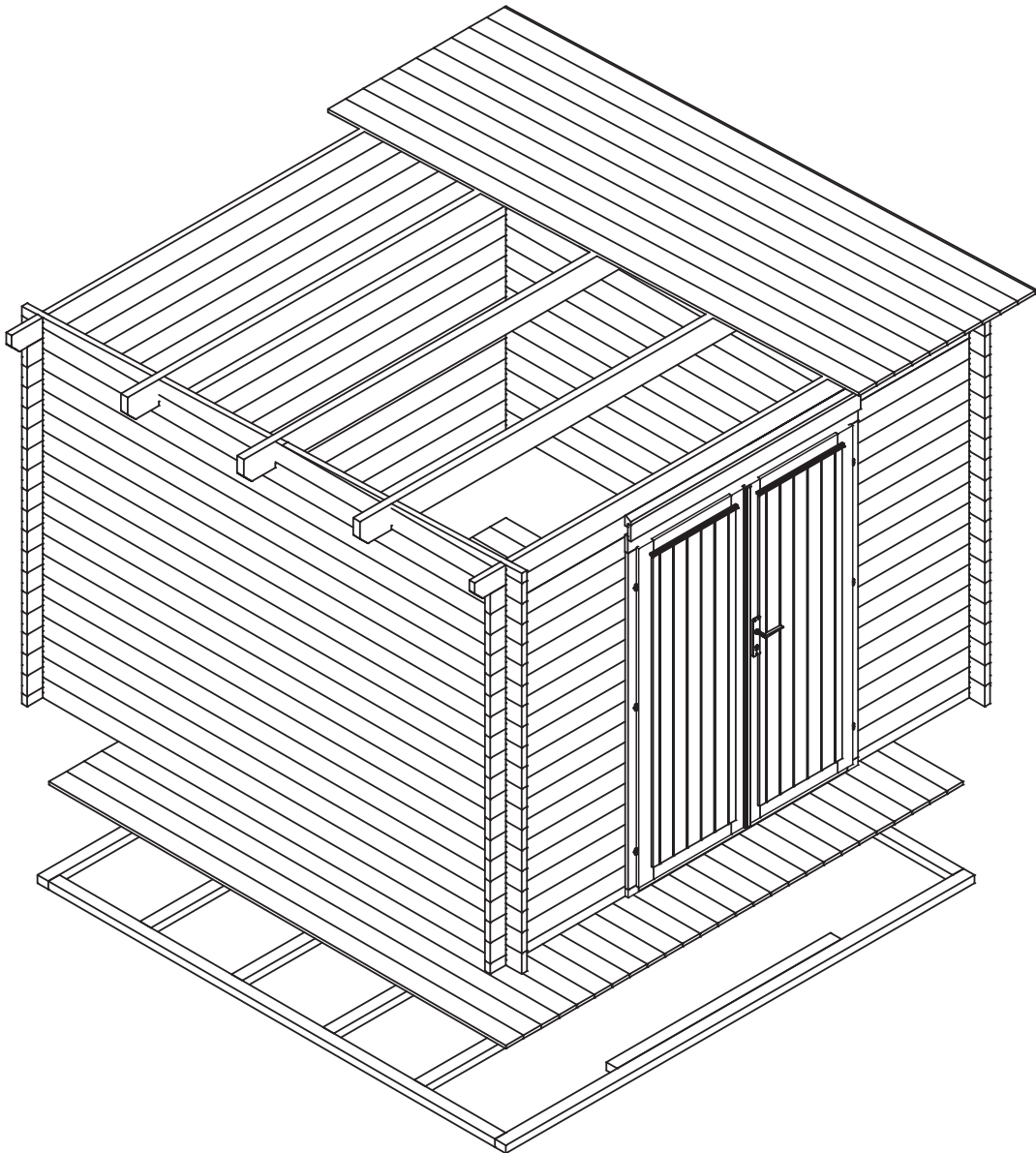

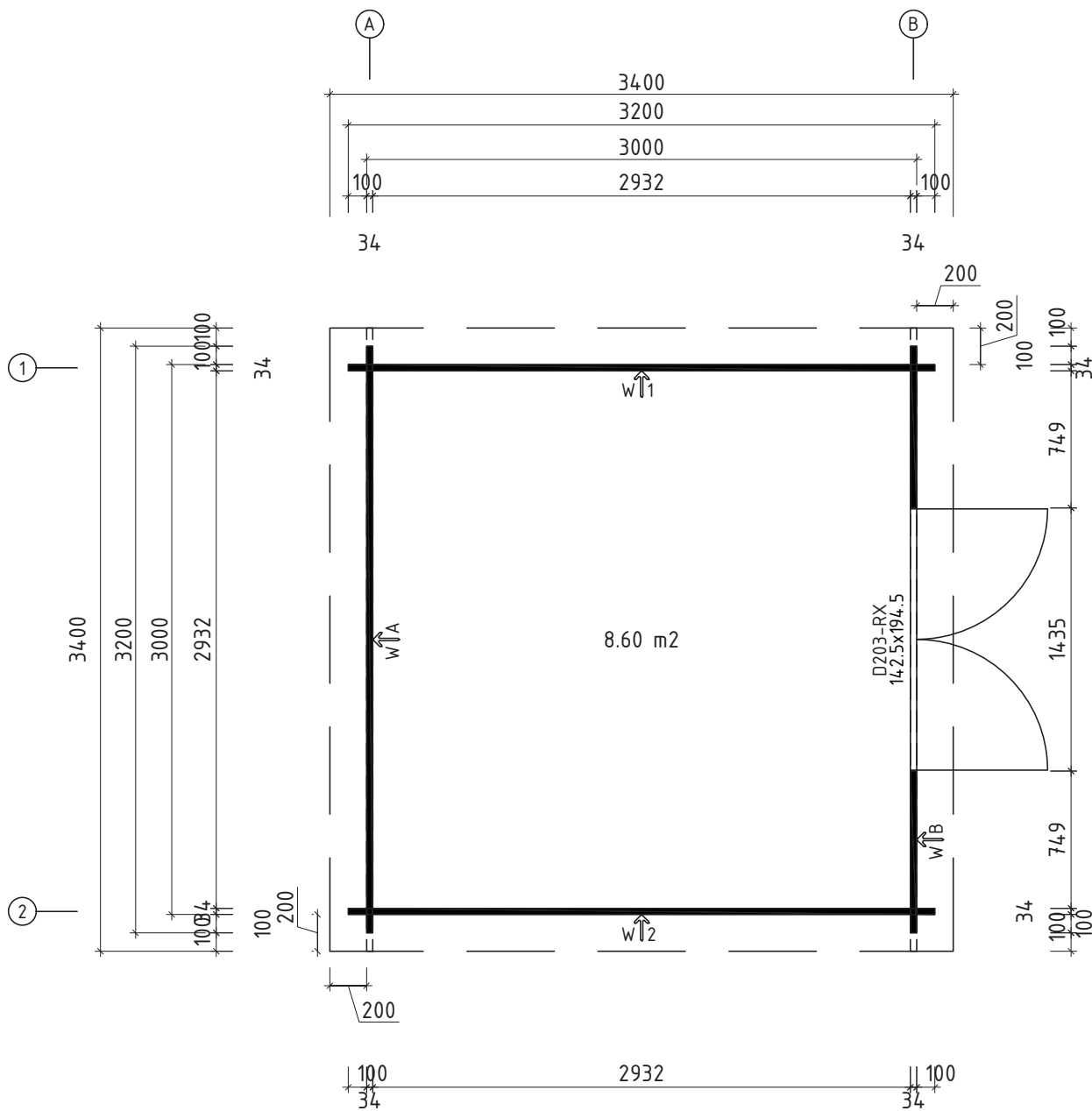







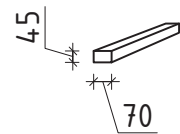
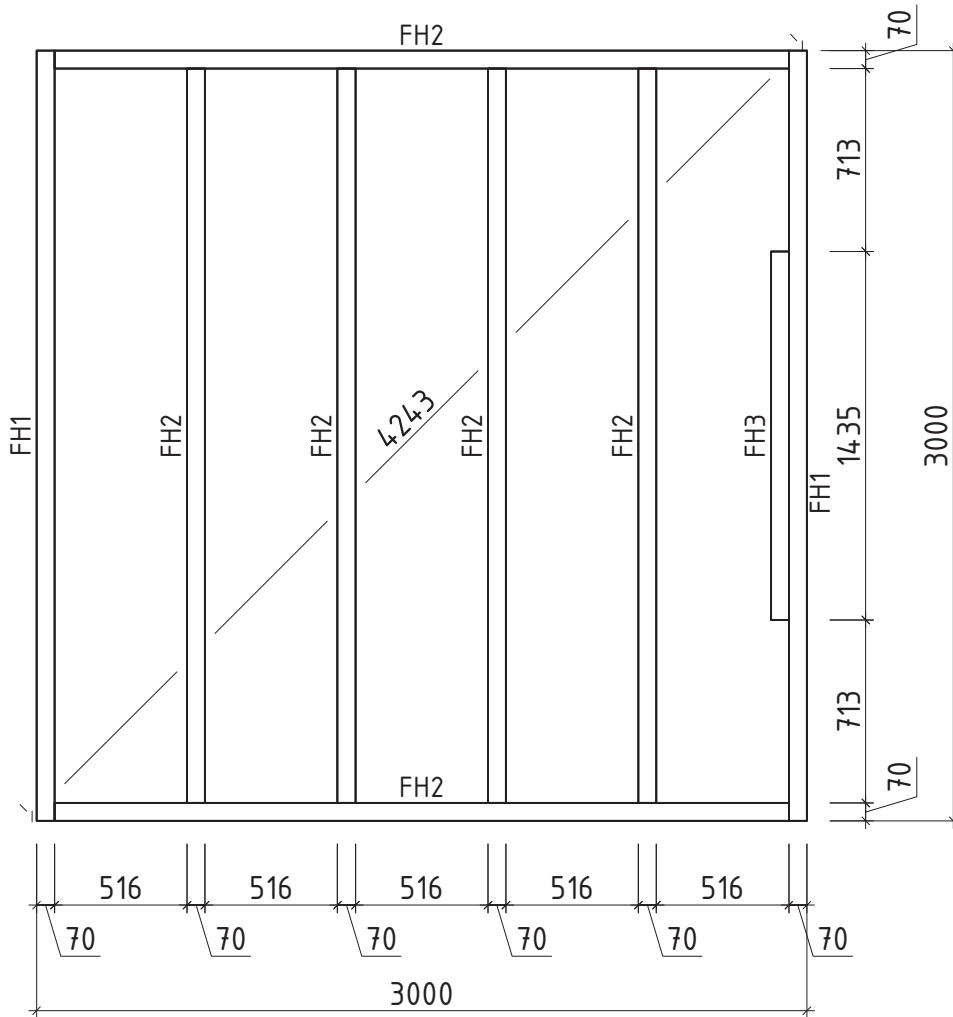

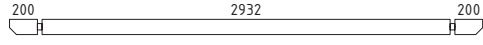
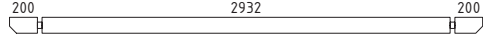
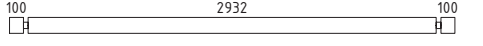
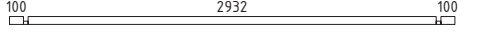
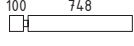
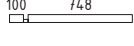
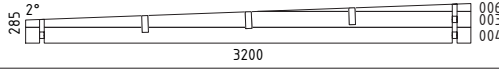
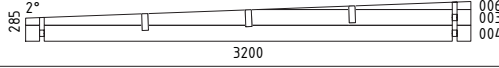



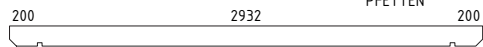

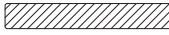

*Fenster und Türen sind mit Sprossen

Q3 – Qualitätsklasse für Fenster und Türen

Wir empfehlen als Fundament für Ihr Gartenhaus eine vollflächig festgegründete, gepflasterte oder betonierte Fläche. Wahlweise ist auch ein Punkt- oder Streifenfundament möglich.

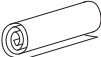

| Pos | Teileliste 534381 | Stck | Profil (mm) | Länge (mm) |
|-------|--|------|----------------|---------------|
| 001 |  | 1 | 34x110 | 3400 |
| 002 |  | 1 | 34x114 | 3400 |
| 004 |  | 52 | 34x114 | 3200 |
| 005 |  | 1 | 34x57 | 3200 |
| 007 |  | 34 | 34x114 | 883 |
| 008 |  | 2 | 34x57 | 883 |
| W1-1 |  | 1 | | |
| W2-1 |  | 1 | | |
| FH1 | FUNDAMENTHÖLZER (imprägniert)  | 2 | 70x45 | 3000 |
| FH2 | FUNDAMENTHÖLZER (imprägniert)  | 6 | 70x45 | 2860 |
| FH3 | FUNDAMENTHÖLZER (imprägniert)  | 1 | 70x45 | 1435 |
| PF1 | PFETTEN  | 3 | 44x145 | 3400 |
| | DACHBRETTER  | 31+1 | 113x18 | 3400 |
| | FUSSBODENBRETTER  | 26+1 | 113x18 | 2925 |
| | FUSSBODENLEISTEN  ✓ | | 18x40 | 13.0lfm |
| G02-1 | GIEBELBRETTER 18x120  ✓ | 2 | 18x120 | 3420 |
| G05-1 | GIEBELDECKLEISTEN 18x40  ✓ | 2 | 18x40 | 3400 |
| T02-1 | TRAUFENBRETTER 18x120  | 1 | 18x120 | 3436 |
| T01-1 | TRAUFENBRETTER 18x95  | 1 | 18x95 | 3400 |
| T04-1 | TRAUFENDECKLEISTEN 18x40  | 1 | 18x40 | 3436 |
| T06-1 | TRAUFENLEISTEN 18x40  ✓ | | 18x40 | 7.0lfm |
| SM-1 | Sturmleisten  | 2 | 18x40 | 2025 |
| SM-2 | Sturmleisten  | 2 | 18x40 | 2140 |
| SH | Schlaghölzer  | 3 | | |
| KP-1 | DACHPAPPE  ✓ | | 3.4m-4st | 14.0lfm |

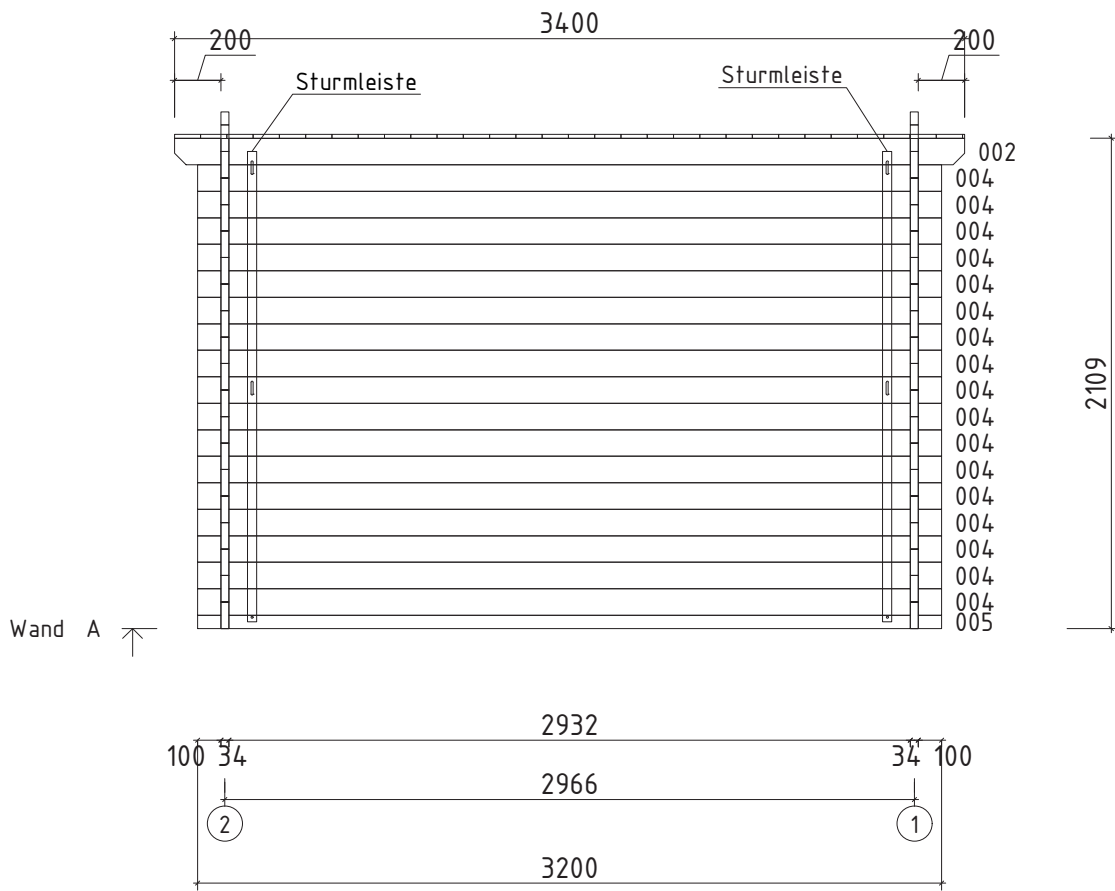

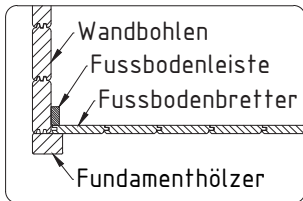
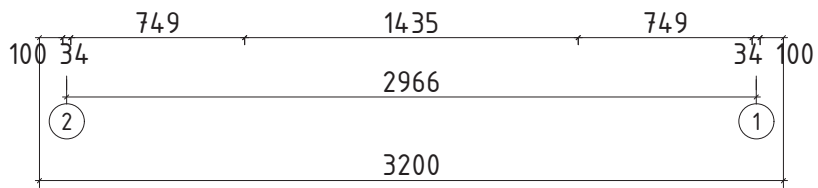
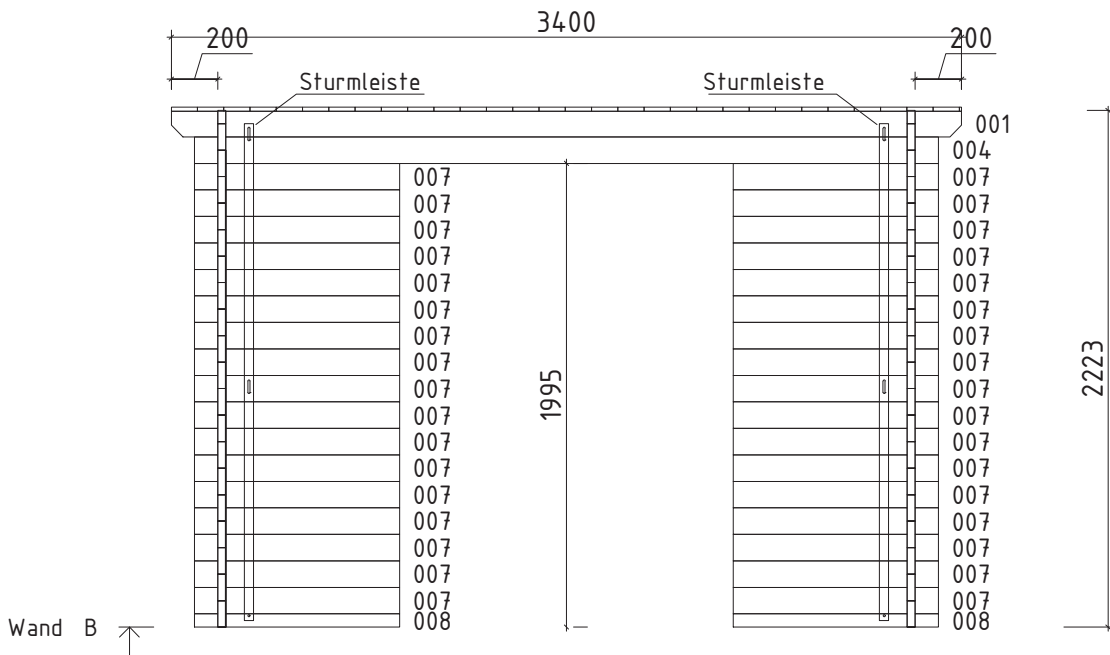
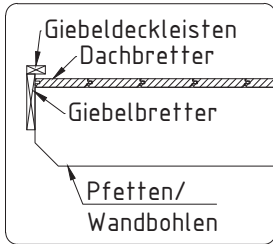

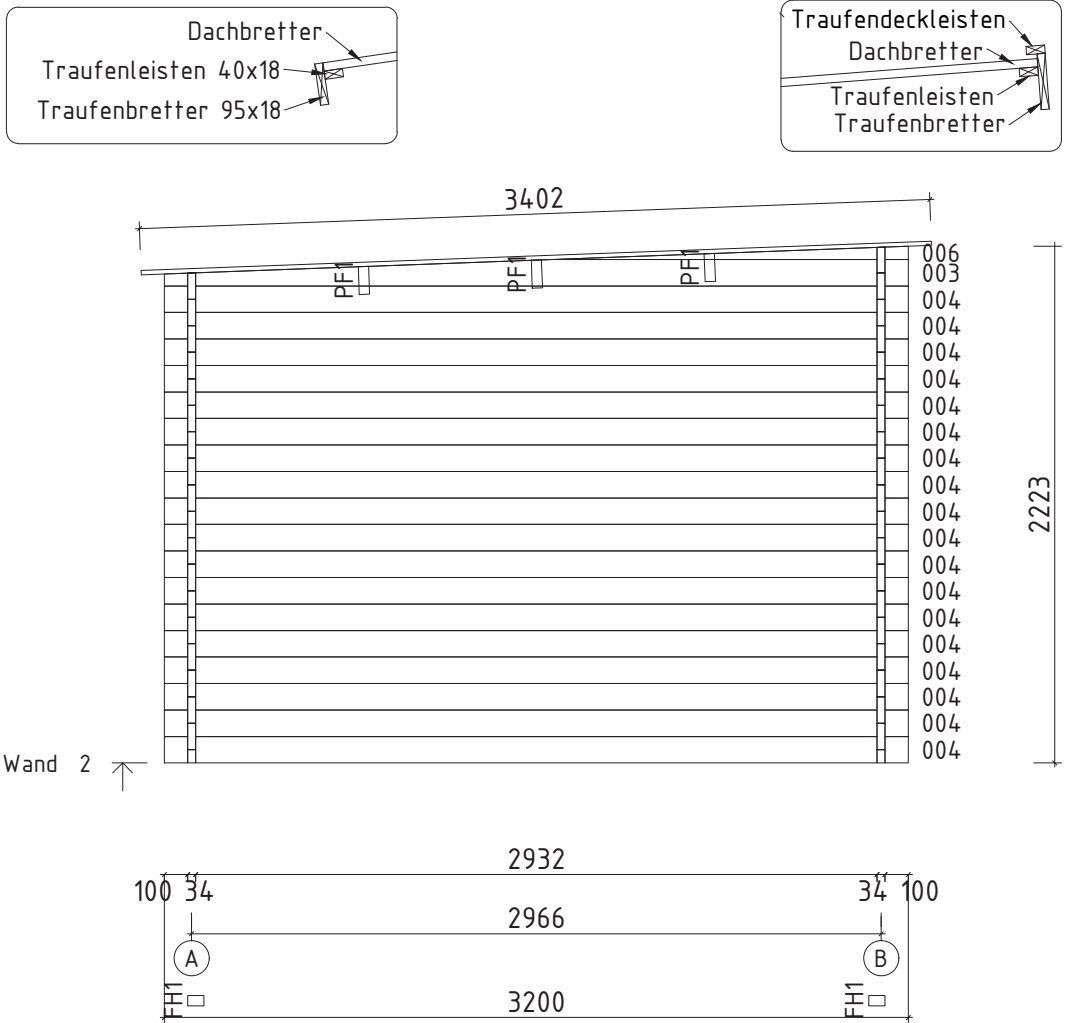

Uks - koostamisjuhhis
 Door - assembly instructions
 Tür - Montageanleitung

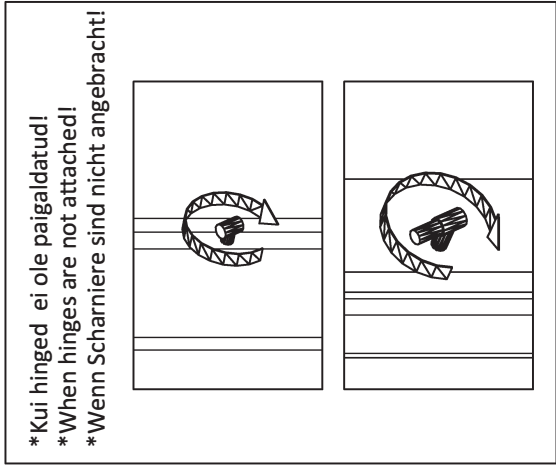
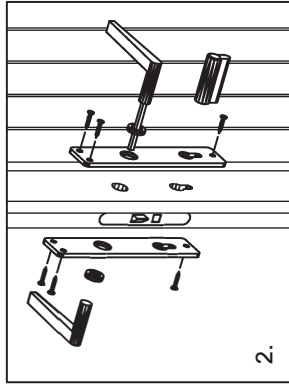
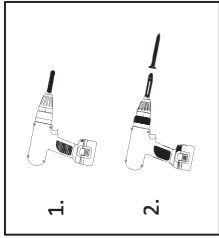
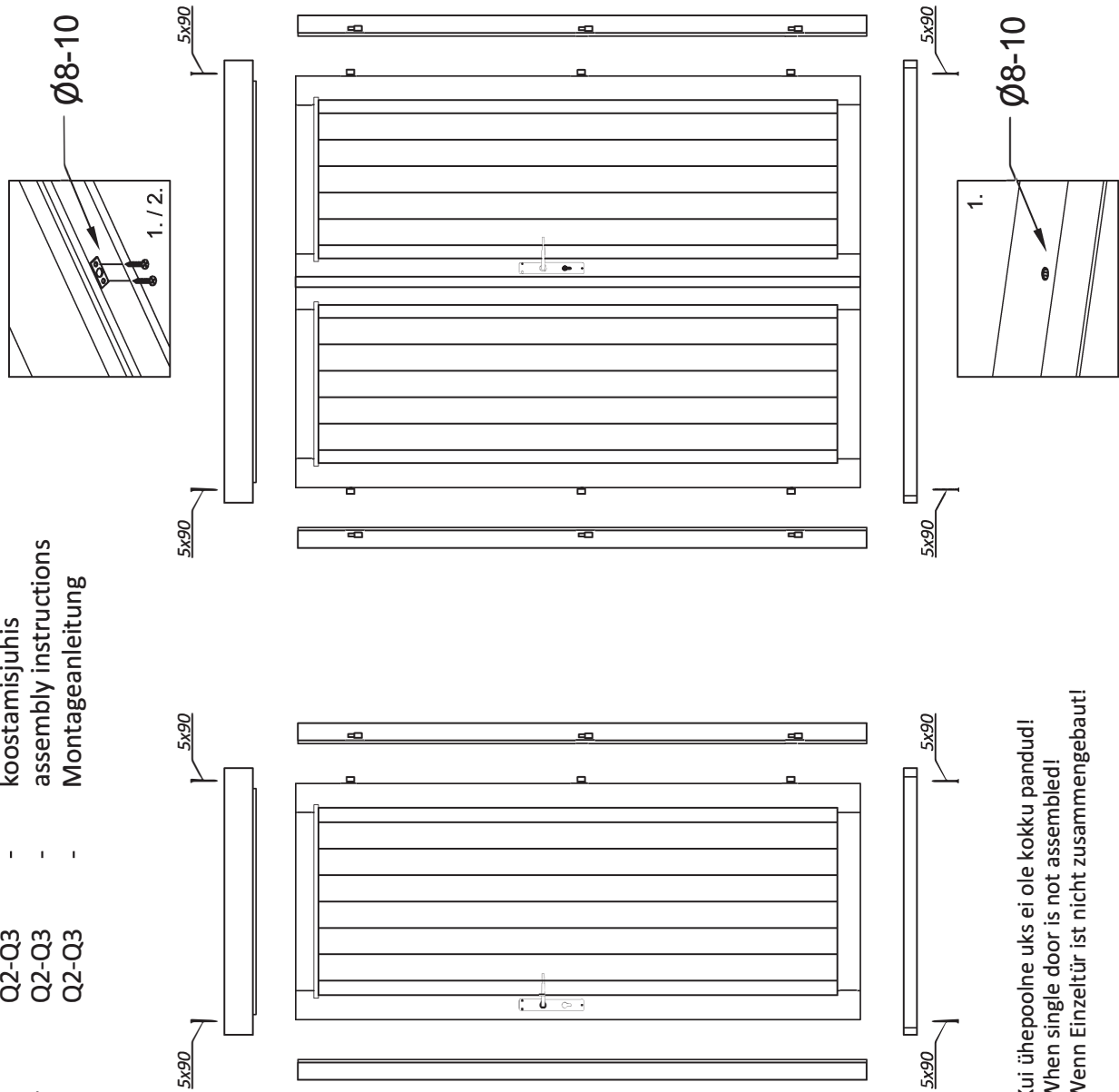

* Kui ühepoolne uks ei ole kokku pandud!
 * When single door is not assembled!
 * Wenn Einzeltür ist nicht zusammengebaut!

Rain strip / Wasserleiste / Vihmaliist

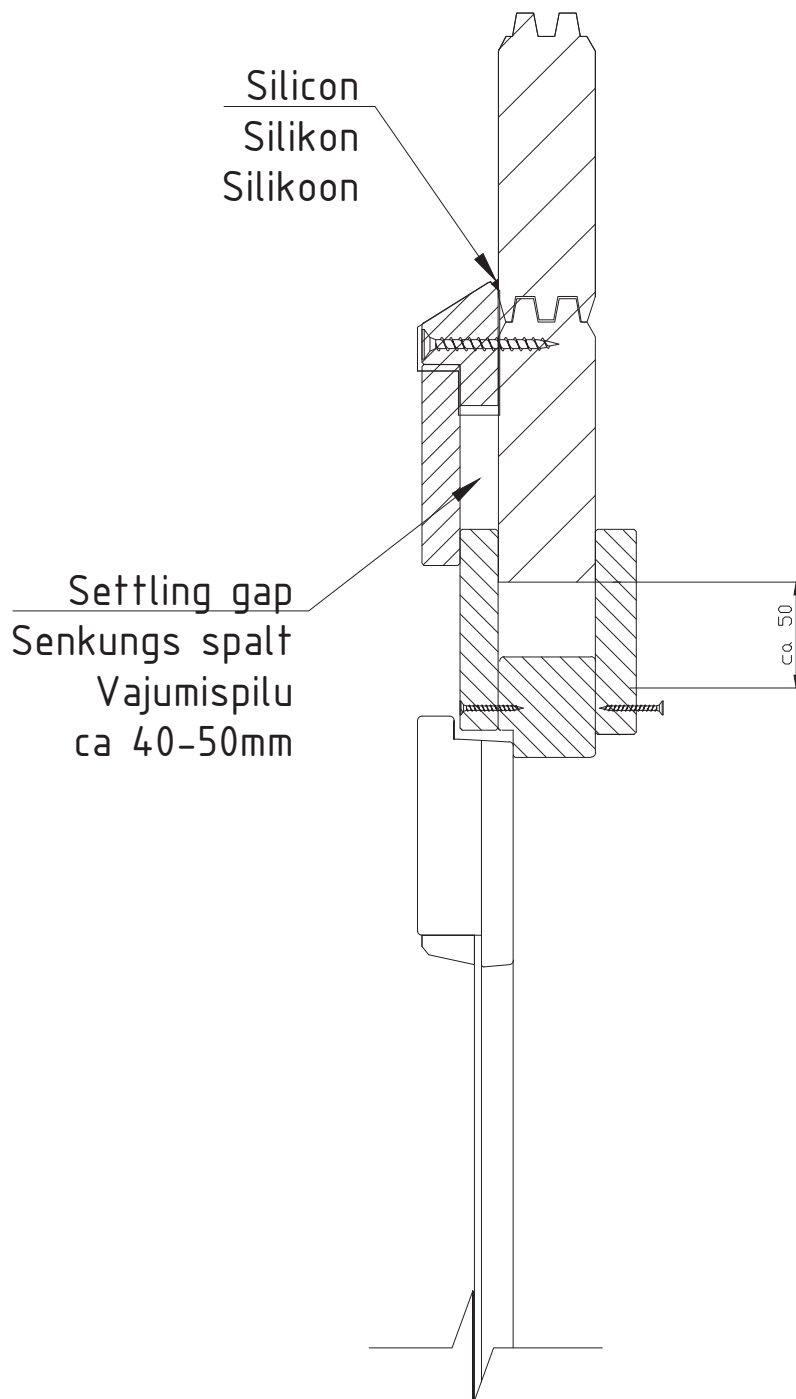

NB!

- Install only if the item is listed in the house specification!
- Nur montieren wenn die Leiste in der Teileliste gezeigt ist!
- Monteerida juhul, kui liist on välja toodud maja spetsifikatsioonis!