

Technische Daten

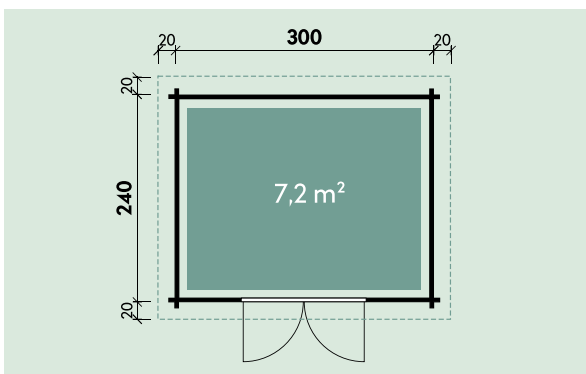

Artikelnummer:

534 371



Kontrolliert durch:

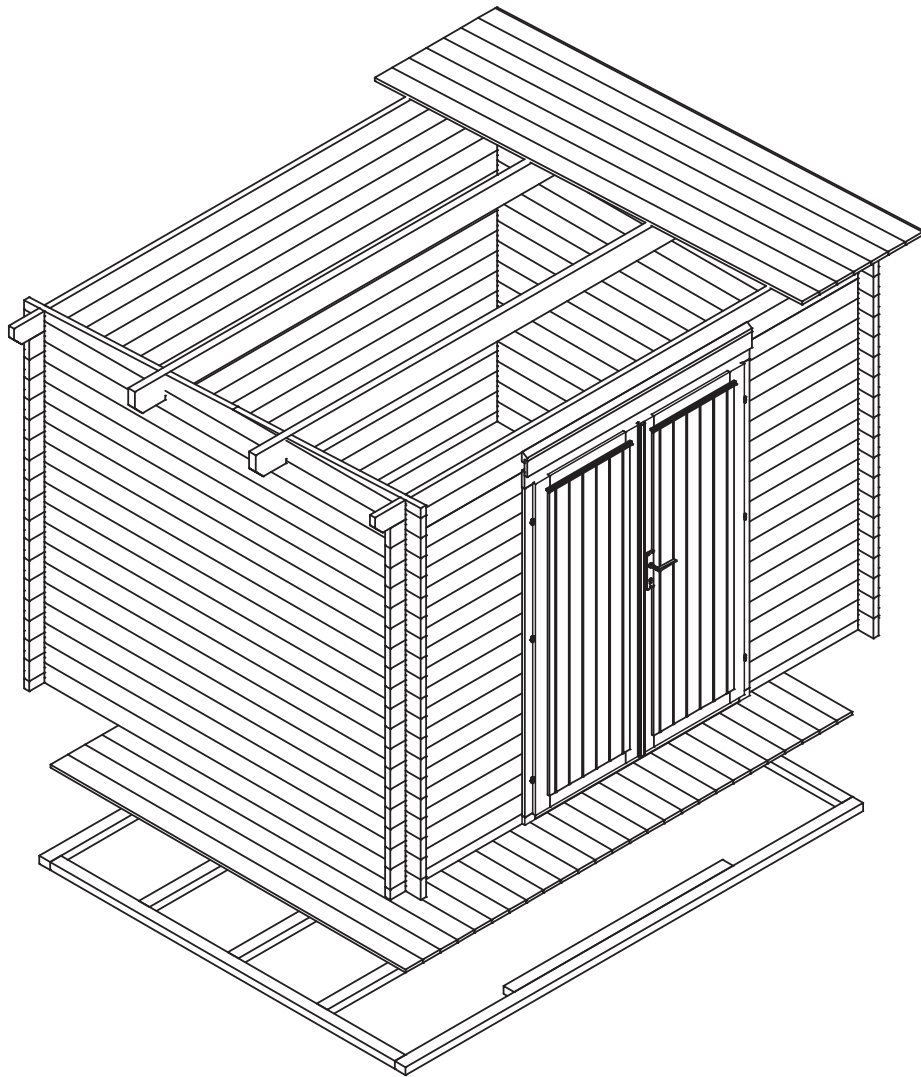

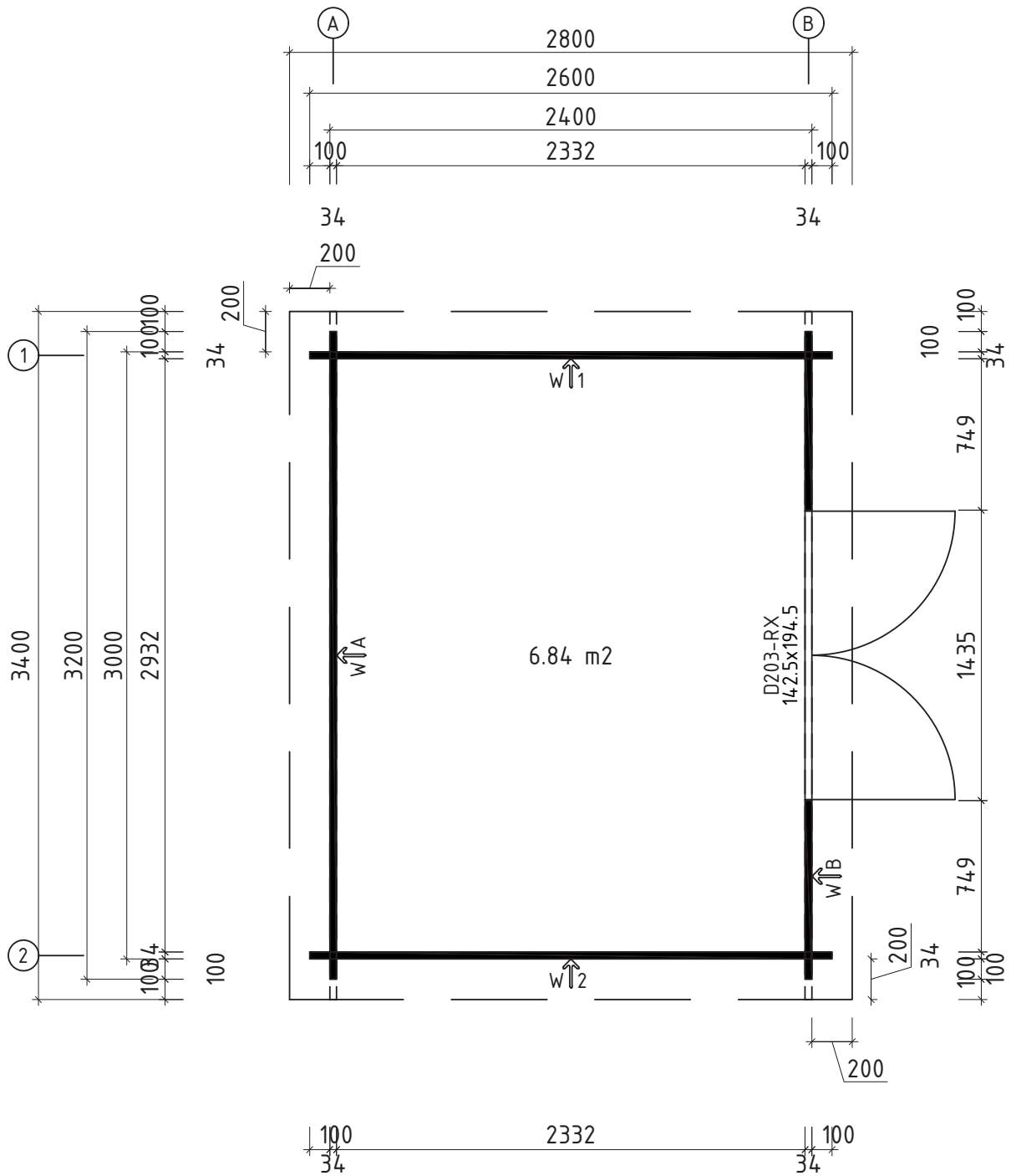







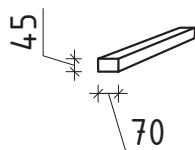
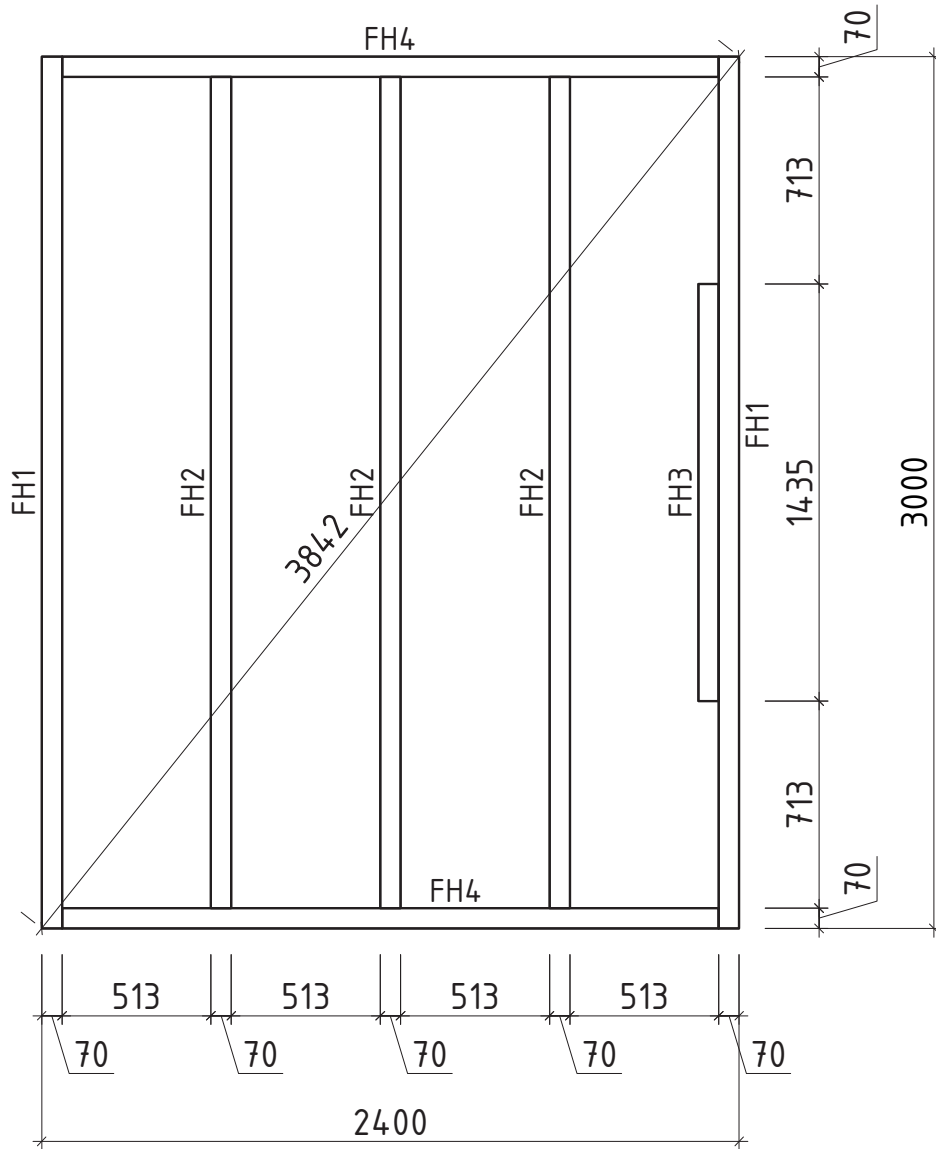

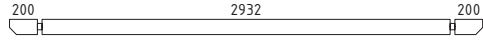
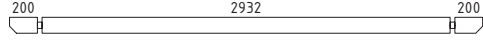
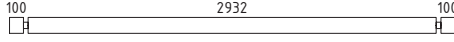
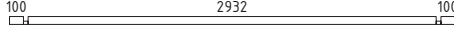
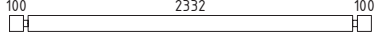
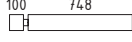
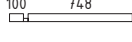
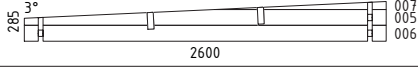
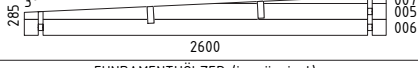



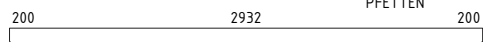
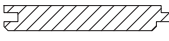

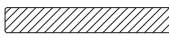







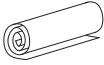

* Fenster und Türen sind mit Sprossen

Q3 – Qualitätsklasse für Fenster und Türen

Wir empfehlen als Fundament für Ihr Gartenhaus eine vollflächig festgegründete, gepflasterte oder betonierte Fläche. Wahlweise ist auch ein Punkt- oder Streifenfundament möglich.

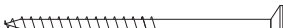
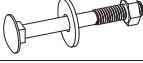

Pos	Teileliste 534371	Stck	Profil (mm)	Länge (mm)
001		1	34x109	3400
002		1	34x114	3400
003		18	34x114	3200
004		1	34x57	3200
006		34	34x114	2600
008		34	34x114	883
009		2	34x57	883
W1-1		1		
W2-1		1		
FH1	FUNDAMENTHÖLZER (imprägniert) 	2	70x45	3000
FH2	FUNDAMENTHÖLZER (imprägniert) 	3	70x45	2860
FH4	FUNDAMENTHÖLZER (imprägniert) 	2	70x45	2260
FH3	FUNDAMENTHÖLZER (imprägniert) 	1	70x45	1435
PF1	PFETTEN 	2	44x145	3400
	DACHBRETTER 	31+1	113x18	2805
	FUSSBODENBRETTER 	26+1	113x18	2325
	FUSSBODENLEISTEN  ✓		18x40	12.0lfm
G02-1	GIEBELBRETTER 18x120  ✓	2	18x120	2825
G05-1	GIEBELDECKLEISTEN 18x40  ✓	2	18x40	2805
T02-1	TRAUFENBRETTER 18x120 	1	18x120	3436
T01-1	TRAUFENBRETTER 18x95 	1	18x95	3400
T04-1	TRAUFENDECKLEISTEN 18x40 	1	18x40	3436
T06-1	TRAUFENLEISTEN 18x40  ✓		18x40	7.0lfm
SM-1	Sturmleisten 	2	18x40	2025
SM-2	Sturmleisten 	2	18x40	2140

Pos	Teileliste 534371	Stck	Profil (mm)	Länge (mm)
SH	Schlaghölzer 	3		
KP-1	DACHPAPPE  ✓		3.4m-4st	14.0lfm
NG01	DACHPAPPNÄGEL 2.8x15 	190		
NG2 550	NÄGEL 2.5x50 Dachbretter 	248		
NG2 550	NÄGEL 2.5x50 Fussbodenbretter 	260		
SR3 030	SCHRAUBEN 3.0x30 Fussbodenleisten 	22		
SR3 030	SCHRAUBEN 3.0x30 Giebeldeckleisten 	12		
SR3 030	SCHRAUBEN 3.0x30 Traufendeckleisten 	8		
SR3 030	SCHRAUBEN 3.0x30 Traufenleisten 	16		
SR3 545	SCHRAUBEN 3.5x45 Giebelbretter 	12		
SR3 545	SCHRAUBEN 3.5x45 Traufenbretter 	16		
SR5 0100	SCHRAUBEN 5.0x100 Fundamenthölzer 	32		
SS024	Schloßschrauben M8x70 Mutter M8 U-Scheibe Ø25 - Befestigung für Sturmleisten 	12		
	✓ - bitte selber anpassen (falls nötig)!			

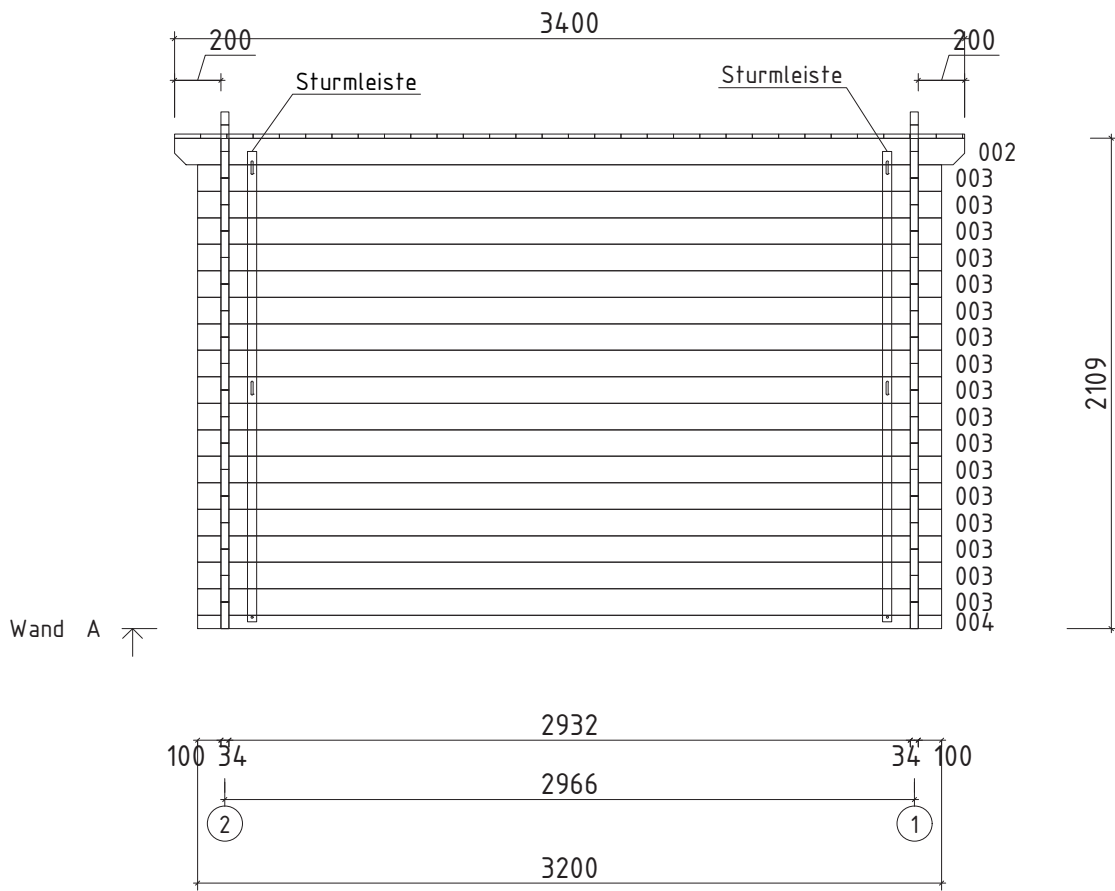

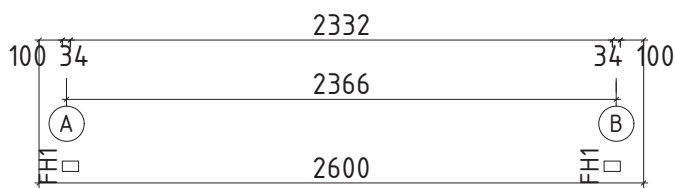
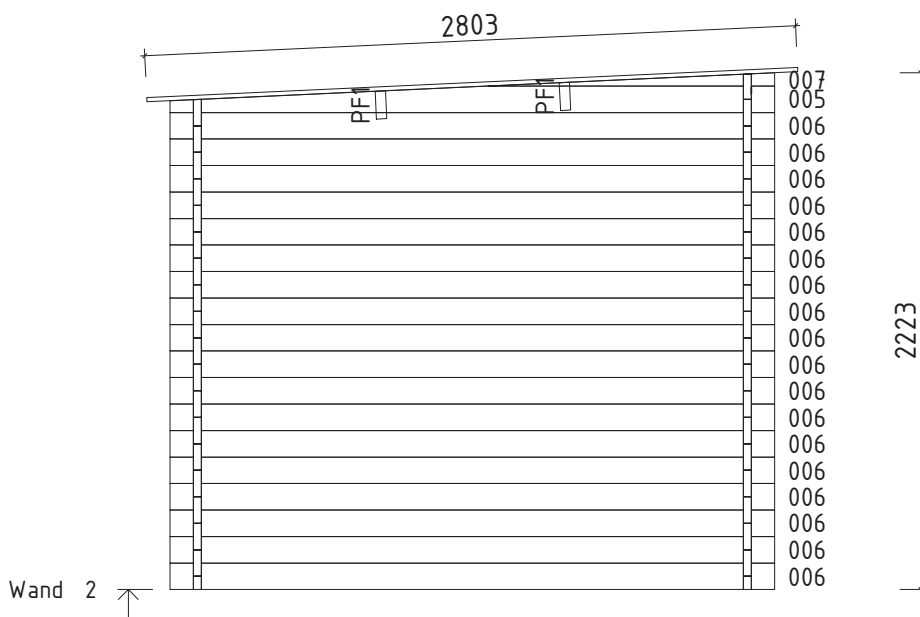
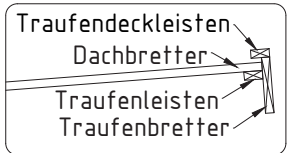
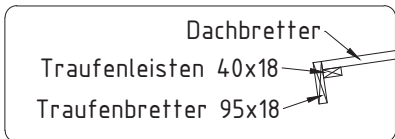

<p>Uks Door Tür</p>	<p>Q2-Q3 Q2-Q3 Q2-Q3</p>	<p>- - -</p>	<p>koostamisjuhhis assembly instructions Montageanleitung</p>		<p>1. 2.</p>
					<p>1. 2.</p>
				<p>* Kui hinged ei ole paigaldatud! * When hinges are not attached! * Wenn Scharniere sind nicht angebracht!</p>	
					<p>1.</p>
				<p>* Kui ühepoolne uks ei ole kokku pandud! * When single door is not assembled! * Wenn Einzeltür ist nicht zusammengebaut!</p>	

Rain strip / Wasserleiste / Vihmaliist

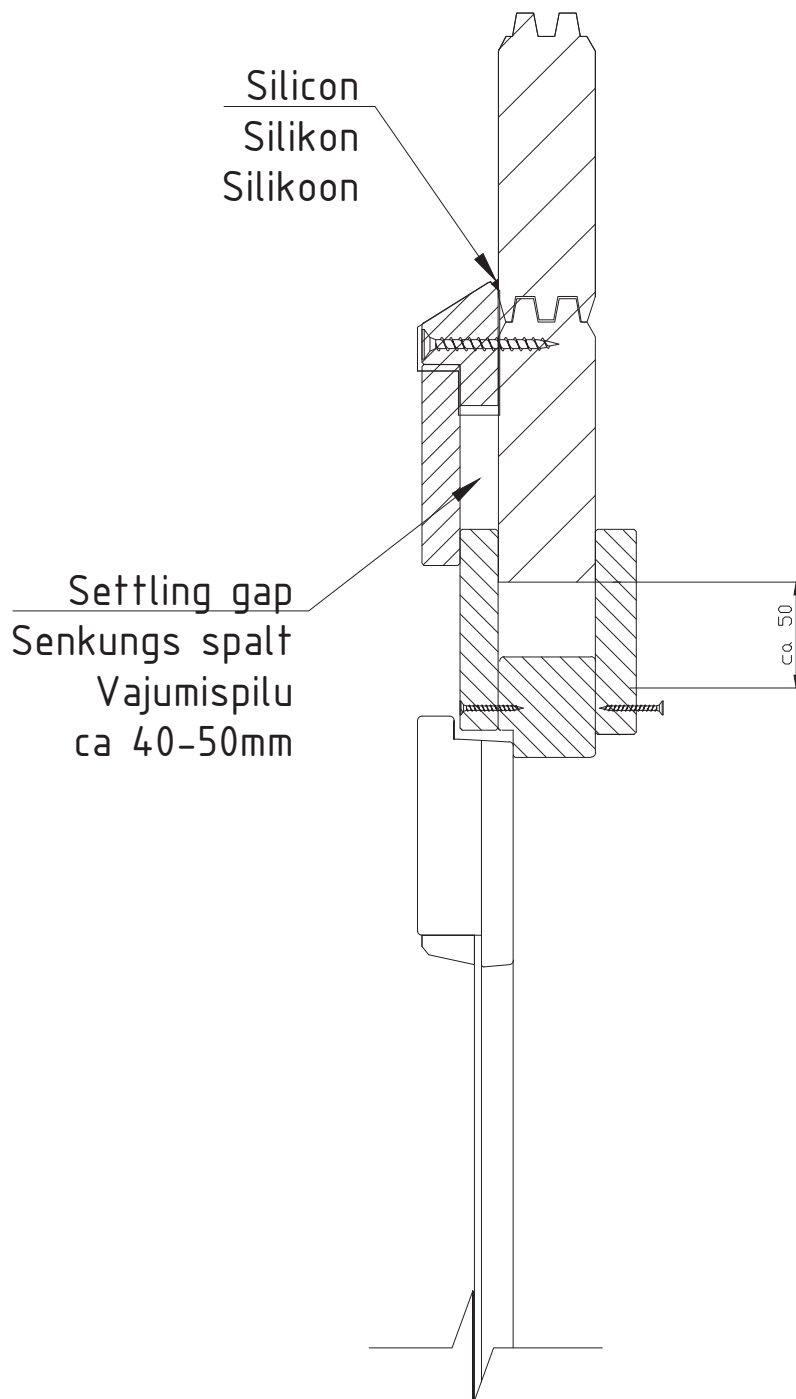

NB!

- Install only if the item is listed in the house specification!
- Nur montieren wenn die Leiste in der Teileliste gezeigt ist!
- Monteerida juhul, kui liist on välja toodud maja spetsifikatsioonis!