

Assembly, installation and maintenance manual

Montage-, Aufbau- und Wartungsanleitung • Assemblage, manuel de montage et d'entretien • Montaje, instalación y mantenimiento • Manuale di montaggio, installazione e manutenzione • Monterings- og vedlikeholdsmanual • Monterings-, installations- och underhållsmanual • Kokoamis-, asennus- ja huolto-ohje • Vejledning for montering og vedligehold • Handleiding voor montage, installatie en onderhoud • Manual de montagem, instalação e manutenção • Návod k montáži, instalaci a údržbě • Instrukcja montażu, instalacji i konserwacji • Surinkimo, montavimo ir priežiūros vadovas • Montāžas, uzstādīšanas un apkopes rokasgrāmata • Руководство по сборке и обслуживанию • Montaaži-, paigaldus- ja säilitamise juhend



Cabin **PM56-4529**

<p>Factory inspection by • Werkskontrolle durch • Contrôle à partir de l'usine par • Inspector de fábrica • Collaudato da • Fabrikkontroll utført av • Fabriksbesiktigat av • Tehtaan tarkastaja • Fabriks Kontrol udført af • Fabrikscontrole door • Inspeção de fábrica, por: • Zkontrolováno ve výrobním závodě • Kontrola fabryczna do • Apžiūrą gamykloje atliko • Rūpnīcas pārbaudi veicis • Заводской контроль • Tehase kontroll teostatud:</p> <p>.....</p>	<p>Date • Datum • Date • Fecha • Data • Dato • Datum • Päiväys • Dato • Datum • Data • Datum • Data • Datums • Data • Дата • Kuupäev:</p>
	<p>Pack number • Pack Nr. • Packet n° • Bulto N° • Pacco N. • Serienr • Produktionsnummer • Pakettinro • Pakke nr. • Pak nr. • Número de embalagem • Číslo balení • Numer opakowania • Pakuotės numeris • Iepakojuma numurs • Упаковочный номер • Pakinumber:</p>



www.palmako.ee/information-hub

English: Before installing and using the product, please read the instructions and warranty terms at www.palmako.ee/information-hub to guarantee proper installation and long-lasting performance.

Deutsch: Wichtig! Bitte vor Aufbau und Nutzung des Produkts unbedingt die detaillierte Montageanleitung sowie die Garantiebedingungen unter www.palmako.ee/information-hub lesen, um eine fachgerechte Montage und eine lange Funktionssicherheit zu gewährleisten.

Français: Avant d'installer et d'utiliser le produit, veuillez lire les instructions et les conditions de garantie sur www.palmako.ee/information-hub afin de garantir une installation correcte et la longévité du produit.

Español: Antes de instalar y utilizar el producto, lea las instrucciones y las condiciones de garantía en www.palmako.ee/information-hub para asegurar una instalación correcta y una larga vida útil del producto.

Italiano: Prima di installare e utilizzare il prodotto, leggere le istruzioni e le condizioni di garanzia su www.palmako.ee/information-hub per garantire una corretta installazione e prestazioni durature.

Norsk: Før montering og bruk av produktet, vennligst les monteringsanvisningene og garantivilkårene på www.palmako.ee/information-hub for å sikre korrekt montering og fremtidig holdbarhet.

Svenska: Innan du installerar och använder produkten, vänligen läs instruktionerna och garantivillkoren på www.palmako.ee/information-hub för att säkerställa korrekt installation och produktens långvariga hållbarhet

Suomi: Ennen tuotteen asentamista ja käyttämistä, lue ohjeet ja takuehdot osoitteessa www.palmako.ee/information-hub varmistaaksesi oikean asennuksen ja pitkäkestoisen toiminnan.

Русский: Перед установкой и использованием изделия ознакомьтесь с инструкцией и условиями гарантии на сайте www.palmako.ee/information-hub, чтобы гарантировать правильную установку и долговечность изделия.

Eesti: Enne toote paigaldamist ja kasutuselevõttu lugege palun juhiseid ja garantiitingimusi aadressil www.palmako.ee/information-hub, et tagada nõuetekohane paigaldus ja toote pikk eluiga.

Dansk (Oversat af AI): Læs venligst instruktionerne og garantibetingelserne på www.palmako.ee/information-hub, før du installerer og bruger produktet, for at garantere korrekt installation og langvarig ydeevne.

Dutch (Vertaald door AI): Lees vóór de installatie en het gebruik van het product de instructies en garantievoorwaarden op www.palmako.ee/information-hub om een correcte installatie en langdurige werking te garanderen

























Português (Traduzido por IA): Antes de instalar e utilizar o produto, leia as instruções e os termos de garantia em www.palmako.ee/information-hub para garantir uma instalação adequada e um desempenho duradouro.

Čeština (Přeloženo umělou inteligencí): Před instalací a použitím produktu si prosím přečtěte pokyny a záruční podmínky na www.palmako.ee/information-hub, abyste zaručili správnou instalaci a dlouhodobý výkon.

Polski (Przetłumaczone przez AI): Przed zainstalowaniem i użyciem produktu należy przeczytać instrukcję oraz warunki gwarancji dostępne na stronie www.palmako.ee/information-hub, co pozwoli zagwarantować prawidłową instalację i długotrwałą wydajność.

Latviešu (Mākslīgā intelekta tulkojums): Pirms produkta uzstādīšanas un lietošanas, lūdzu, izlasiet instrukcijas un garantijas noteikumus vietnē www.palmako.ee/information-hub, lai garantētu pareizu uzstādīšanu un ilgstošu darbību.





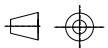

















Lietuviškai (Išvertė DI): Prieš montuodami ir naudodami gaminį, perskaitykite instrukcijas ir garantijos sąlygas adresu www.palmako.ee/information-hub, kad užtikrintumėte tinkamą montavimą ir ilgalaikį veikimą.

Pos	SPECIFICATION-STÜCKLISTE-NOMENCLATURE-ELEMENTI Grace_12.4m2+4.1m2	Pcs	Profile (mm)	Length (mm)
1	Log Plank 	1	56 x 518	475
2	Log Plank 	1	56 x 518	3125
3	Log Plank 	3	56 x 535	475
4	Log Plank 	3	56 x 535	450
5	Log Plank 	3	56 x 535	475
6	Log Plank 	1	56 x 356	5980
8	Log Plank 	3	56 x 535	870
9	Log Plank 	1	56 x 535	1268
10	Log Plank 	1	56 x 352	2914
11	Log Plank 	1	56 x 518	4450
12	Log Plank 	2	56 x 535	4450
13	Log Plank 	1	56 x 535	5785
14	Log Plank 	1	56 x 98	5980
15	Log Plank 	1	56 x 518	2914
16	Log Plank 	2	56 x 535	1864
17	Log Plank 	3	56 x 535	400
18	Log Plank 	1	56 x 535	1864
19	Log Plank 	1	56 x 352	2914
23	Log Plank 	1	56 x 518	870
25	Log Plank 	2	56 x 535	1268
26	Log Plank 	3	56 x 535	900
28	Log Plank 	1	56 x 518	1268
29	Log Plank 	1	56 x 518	2914
30	Log Plank 	2	56 x 535	2914

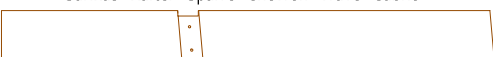

Object name

Grace_12.4m2+4.1m2



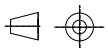







Pos	SPECIFICATION-STÜCKLISTE-NOMENCLATURE-ELEMENTI Grace_12.4m2+4.1m2	Pcs	Profile (mm)	Length (mm)
31	Log Plank 	1	56 x 350	2888
32	Log Plank 	1	56 x 535	2914
100	Katuselaud- Roof board- Dachbrett- Madrier du toit- Tavola tetto- Tabla de tejado 	9	89 x 19	2250
101	Pörandaliist- Floor beading- Fussbodenleiste- Baguette du plancher- Listello pavimento- Listón de suelo 	2	19 x 45	1457
102	Pörandaliist- Floor beading- Fussbodenleiste- Baguette du plancher- Listello pavimento- Listón de suelo 	4	19 x 45	2888
103	Pörandalaud- Floor board- Fussbodenbrett- Madrier du plancher - Tavola pavimento-Tabla de suelo 	25	114 x 28	1489
104	Alusraam- Foundation- Fundament- Fondation- Fondazione- Vigas de cimentación 	10	80 x 60	2830
105	Pörandaliist- Floor beading- Fussbodenleiste- Baguette du plancher- Listello pavimento- Listón de suelo 	2	19 x 45	2750
106	Pörandalaud- Floor board- Fussbodenbrett- Madrier du plancher - Tavola pavimento-Tabla de suelo 	25	114 x 28	2783
107	Katuselaud- Roof board- Dachbrett- Madrier du toit- Tavola tetto- Tabla de tejado 	9	89 x 19	3730
108	Katuse äär- Eave edging- Dachrandbrett- Madrier en bordure du toit- Tavola bordo tetto- Tabla de valadizo 	1	19 x 95	2780
109	Katuse roov- Roof edge reinforcement- Dachrandleiste- Baguette en bordure du toit- Rinforzo bordo tetto- Refuerzo borde tejado 	2	45 x 45	2990
110	Katuselaud- Roof board- Dachbrett- Madrier du toit- Tavola tetto- Tabla de tejado 	68	89 x 19	3230
112	Sarikas- Rafter- Sparre- Chevron- Trave- Cabrio 	7	44 x 140	1350
113	Katuse äär- Eave edging- Dachrandbrett- Madrier en bordure du toit- Tavola bordo tetto- Tabla de valadizo 	1	19 x 95	3200
114	Katuse katteliist- Covering board- Deckbrett- Madrier de couverture- Tavola di copertura- Listón de cubierta 	1	19 x 70	2270
115	Katuse äär- Eave edging- Dachrandbrett- Madrier en bordure du toit- Tavola bordo tetto- Tabla de valadizo 	2	18 x 150	3010
116	Sarikas- Rafter- Sparre- Chevron- Trave- Cabrio 	1	44 x 140	1350
117	Sarikas- Rafter- Sparre- Chevron- Trave- Cabrio 	1	44 x 140	1350
118	Katuse katteliist- Covering board- Deckbrett- Madrier de couverture- Tavola di copertura- Listón de cubierta 	2	19 x 70	4015
119	Katuse katteliist- Covering board- Deckbrett- Madrier de couverture- Tavola di copertura- Listón de cubierta 	1	19 x 70	3750
120	Katuse äär- Eave edging- Dachrandbrett- Madrier en bordure du toit- Tavola bordo tetto- Tabla de valadizo 	2	18 x 150	4080
121	Pärilin- Purlin- Dachpfette- Arbalétrier- Arcareccio- Vigueta de tejado 	3	56 x 180	5980
122	Pärilin- Purlin- Dachpfette- Arbalétrier- Arcareccio- Vigueta de tejado 	1	56 x 180	5980

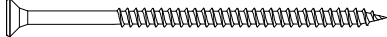
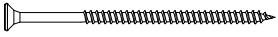
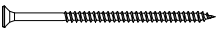

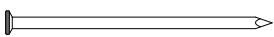
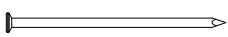
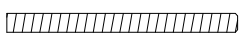
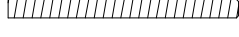



Object name

Grace_12.4m2+4.1m2

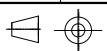
Page 2 / 5

Pos	SPECIFICATION-STÜCKLISTE-NOMENCLATURE-ELEMENTI GRACE_12.4M2+4.1M2	Pcs	Code/ Profile	Info
F1	TÜÜBEL- DOWEL- DÜBEL- CHEVILLE- TASSELLO- ESPIGA- QTY16X130 	130	QTY16x130 16x16x130	To Log Planks
F2	TIHEND- SEAL- DICHTUNG- JOINT D'ISOLATION- GUARNIZIONE- BURLETE- QT115 	10	QT115 15x15x10000	To Log Planks
F3	TIHEND- SEAL- DICHTUNG- JOINT D'ISOLATION- GUARNIZIONE- BURLETE- QT140 	2	QT140 40x40x2100	To top of doors & windows
F4	KRUVI- SCREW- SCHRAUBE- VIS- VITE- TORNILLO- 6X120MM 	154	QKRPP6x120ZnTx ø6 x 120	20 to foundation, 76 to Log Planks, 40 to rafters, 18 to purlins
F5	KRUVI- SCREW- SCHRAUBE- VIS- VITE- TORNILLO- 4.5X70MM 	38	QKRPP4_5x70TxZn ø4.5 x 70	to wall + foundation; to 136,137
F6	KRUVI- SCREW- SCHRAUBE- VIS- VITE- TORNILLO- 4.5X50MM 	190	QKRPP4_5x50TxZn ø4.5 x 50	50 to floor beading;12 to louver;116 to roof slats;8 to corner slats; 4 to louvre
F7	KRUVI- SCREW- SCHRAUBE- VIS- VITE- TORNILLO- 5X40MM 	4	QKRYP5x40ZnTX ø5 x 40	to L-iron 50x65x130
F8	Screw- Schraube- Vis- Vite- Tornillo- 3.5x16mm ZnY 	4	QKRYP3_5x16Zn	to L-iron 50x65x130
F9	NAEL- NAIL- NAGEL- CLOU- CHIODO- CLAVO- 3X70MM 	250	QNA3x70ZN	To floor board
F10	NAEL- NAIL- NAGEL- CLOU- CHIODO- CLAVO- 2,2X50MM 	550	QNA2.2x50ZN	To roof board
F11	Keermelatt- Threaded rod- Gewindestangen- Barre fileée- Asta filettata- Varilla roscada M8 	4	QKE8 ø8 x 2000	To walls
F12	Keermelatt- Threaded rod- Gewindestangen- Barre fileée- Asta filettata- Varilla roscada M8 	2	QKE8 ø8 x 300	To walls
F13	MUTTER- NUT- SCHRAUBENMUTTER- ÉCROU- DADO- TUERCA- M8MM 	4	QMUKK8Zn M8	To walls
F14	SEIB- WASHER- DICHTSCHEIBE- JOINT- RONDELLA- ARANDELA- 8X20MM 	4	QSE8x20Zn ø8 x 20	To walls
F15	JÄTKUMUTTER- EXTENSION NUT- VERLÄNGERUNGSMUTTER- ÉCROU RALLONGE- DADO DI PROLUNGA- TUERCA DE EXTENSIÓN 	2	QMUJ8Zn	To walls
F16	LÖÖGIMUTTER- CAPTIVE NUT- EINSCHLAGMUTTER- ÉCROU A GRIFFES- DADO A RAGNO FILETTATURA- TUERCA ARANA- LM8 	4	QMULG8Zn	To walls
F17	AVA KATE- COVERING CAP - ABDECKKAPPE - COUVERCLE - COPERTURA- CUBIERTA 	4	QKA85	To walls
F18	KRUVI- SCREW- SCHRAUBE- VIS- VITE- TORNILLO- 4.5X40MM 	44	QKRPP4_5x40TxZn ø4.5 x 40	to T-posts

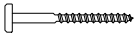
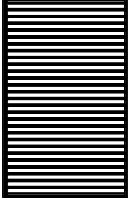

Pos	SPECIFICATION-STÜCKLISTE-NOMENCLATURE-ELEMENTI GRACE_12.4M2+4.1M2	Pcs	Code/ Profile	Info
F19	L-iron- Winkel- Angle -Angolo- Angulo QNU50x65x130Zn 	2	QNU50x65x130Zn	To louver
F20	Bolt -Schloss-schraube -Boulon- Bullone- Perno- 8x30mm KSKR 	2	QKRKK8x30Zn	to L-iron 50x65x130
F21	Furniture screw- Innensechskantschraube- Vis Allen- Vite Allen- Tornillo Allen- 6.3x80mm 	8	QKRYP6_3x80kZnSK	to corner slats
	žaluzii- Louver- das Lattenfenster- la persienne- la persiana 70 x 1190 x 1880 	1		
	 Object name GRACE_12.4M2+4.1M2			Page 5 / 5

5730

1290

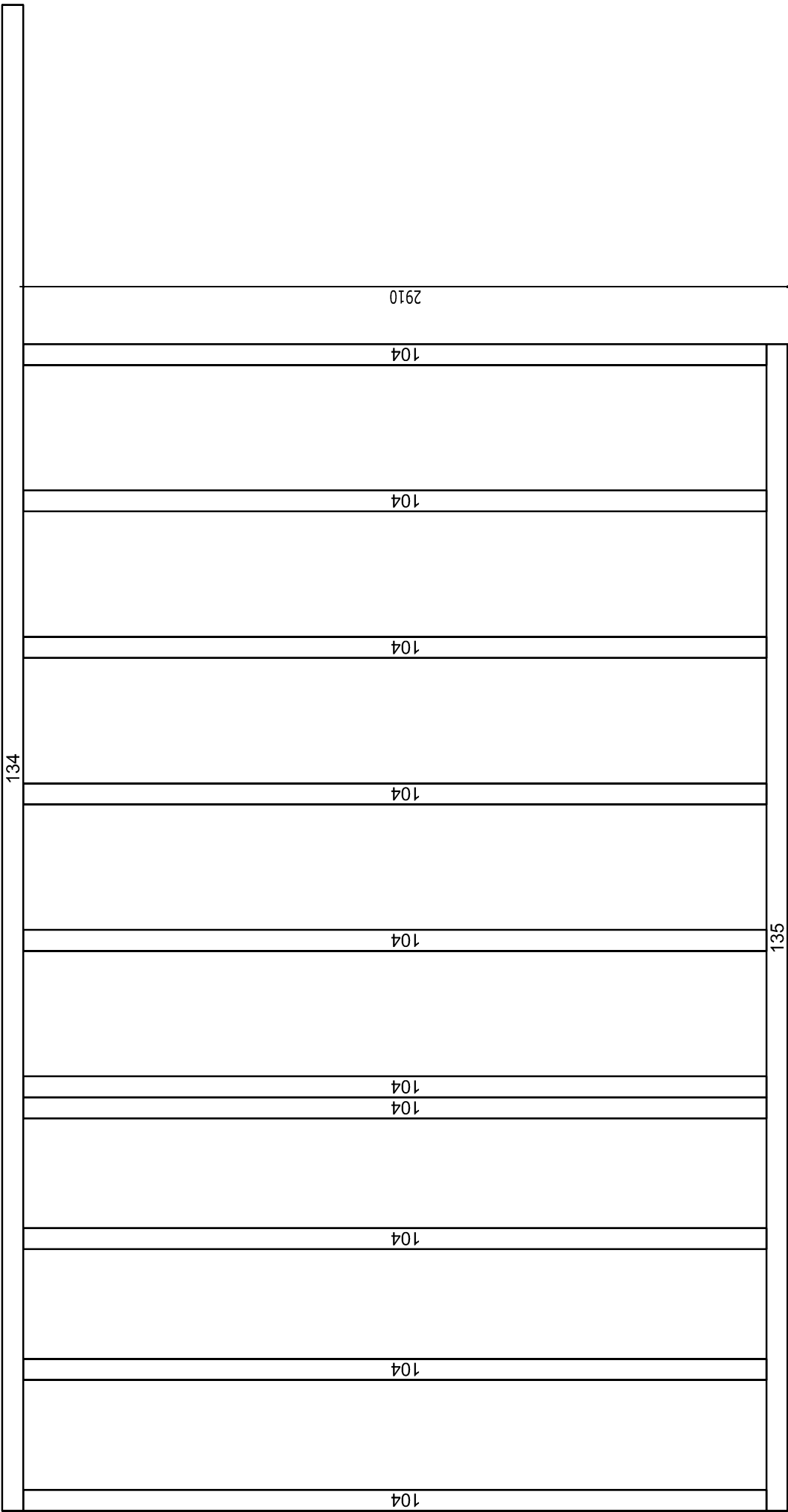

2910

104

104

104

104

104

104

104

104

104

104

80

477

80

477

80

477

80

477

80

477

160

418

80

418

80

418

80

80

4440

80

2990

80

Grace 12.4+4.1 Plan

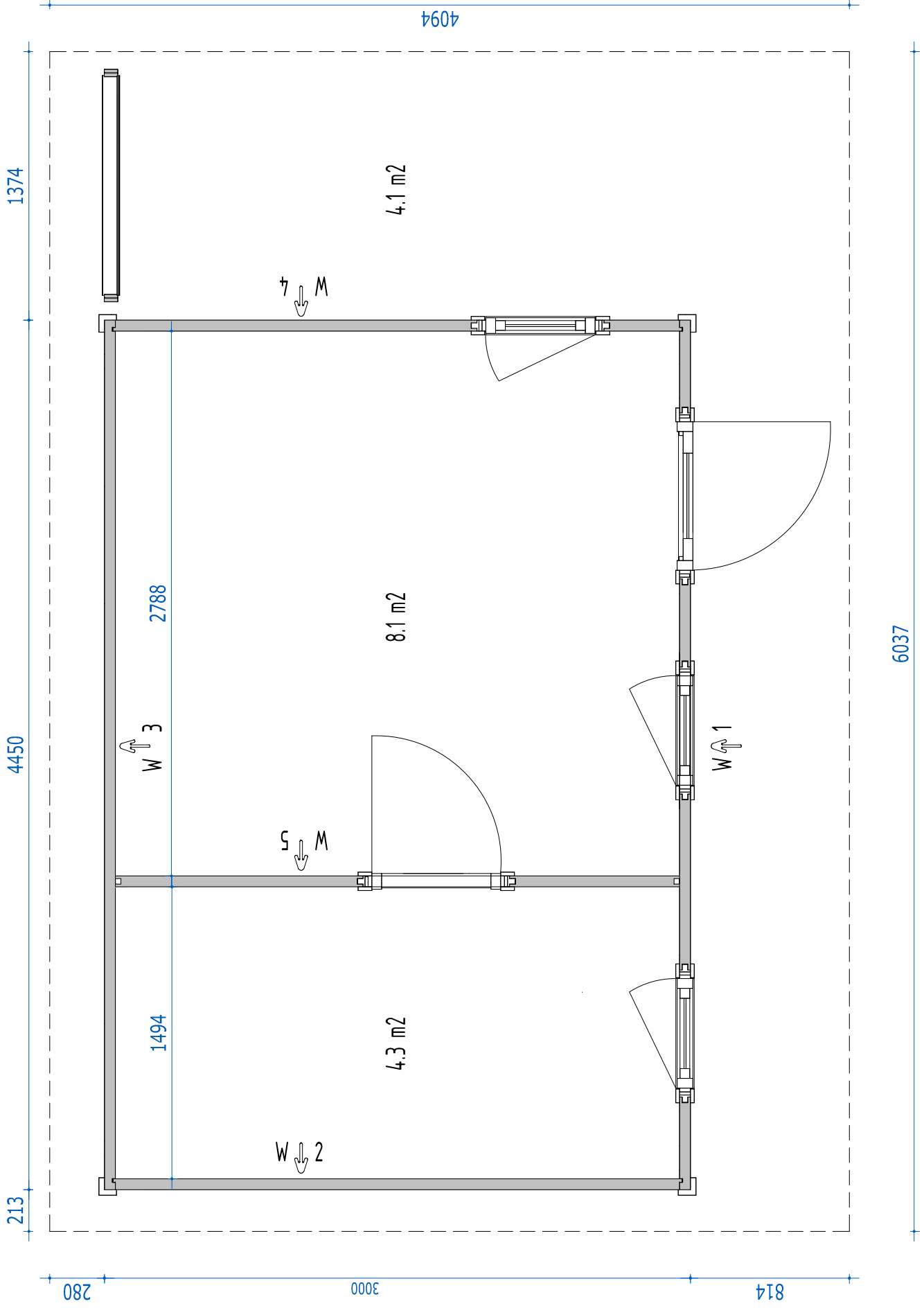

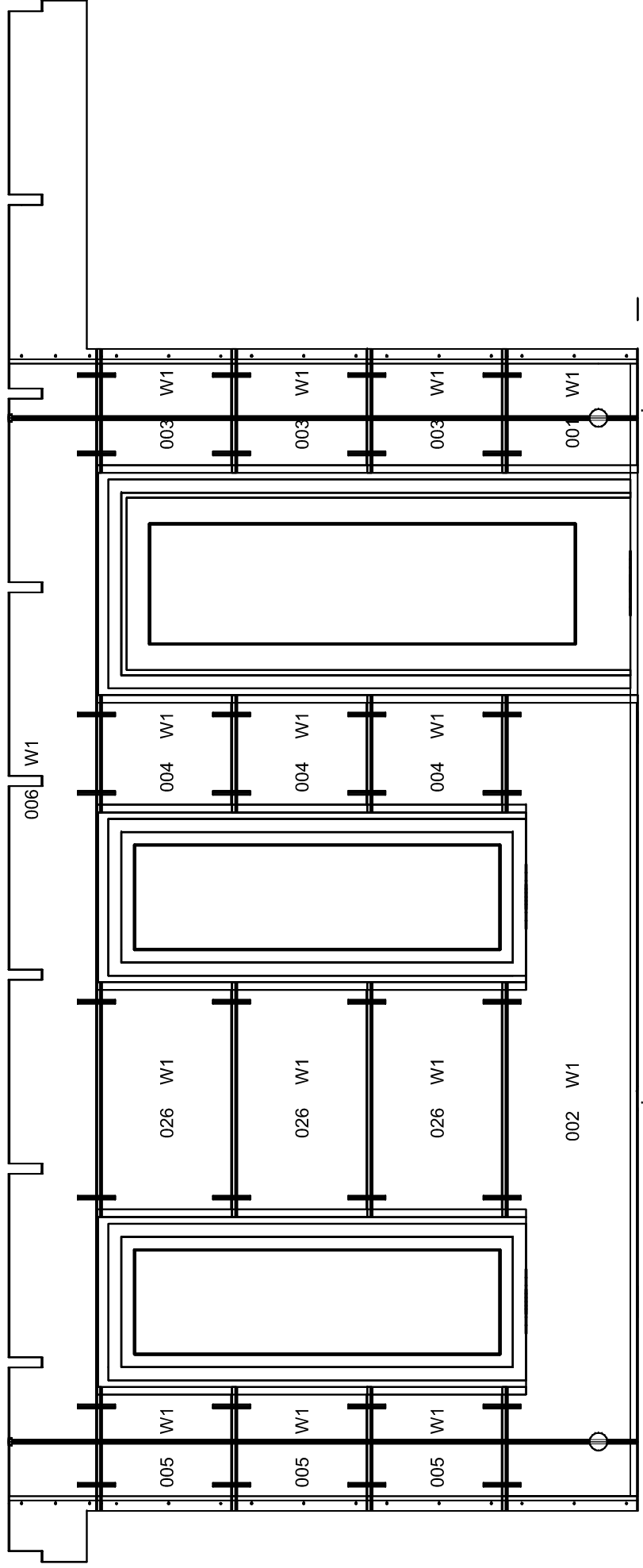

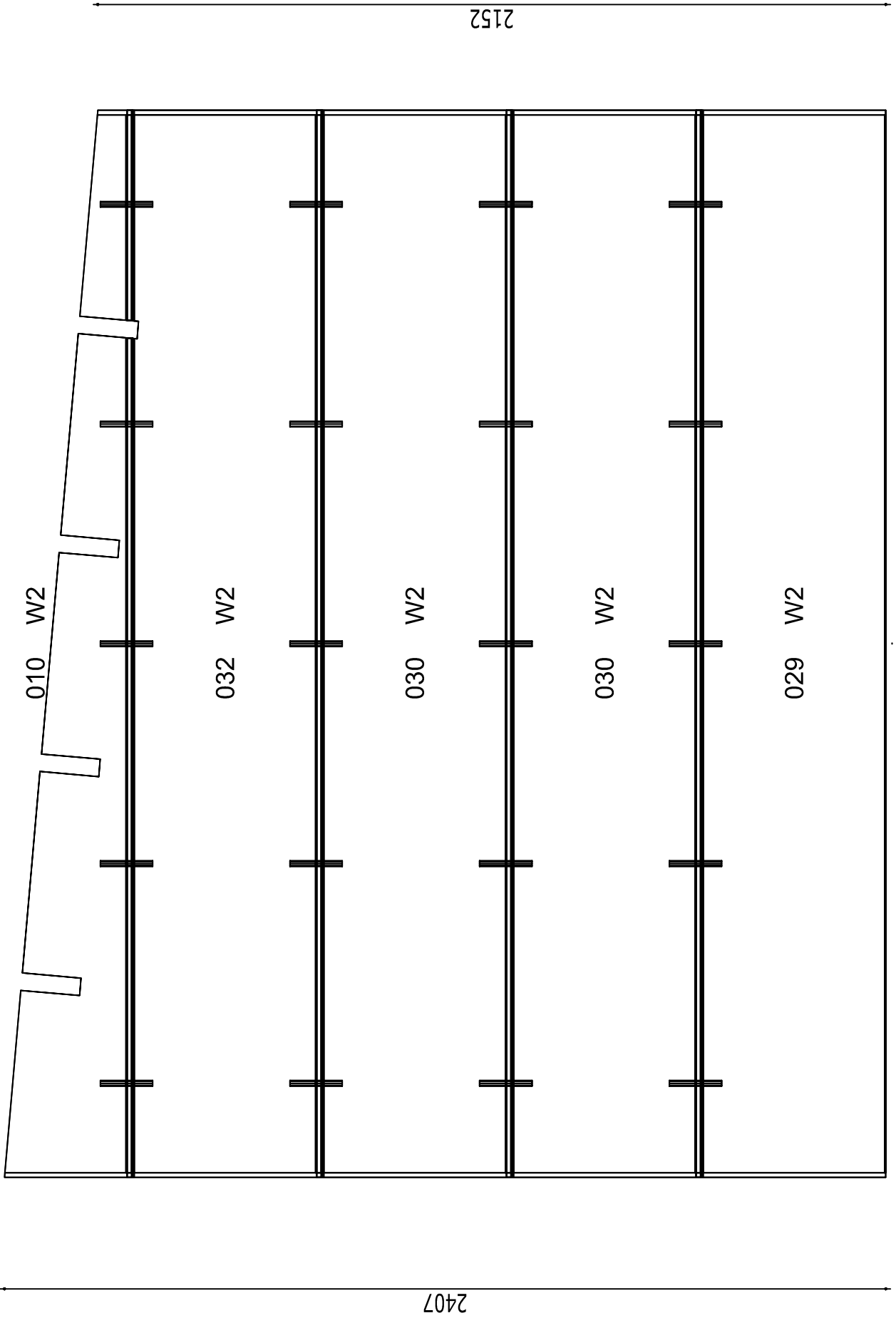

5980

014 W3

013 W3

012 W3

012 W3

011 W3

2153

4450

1335

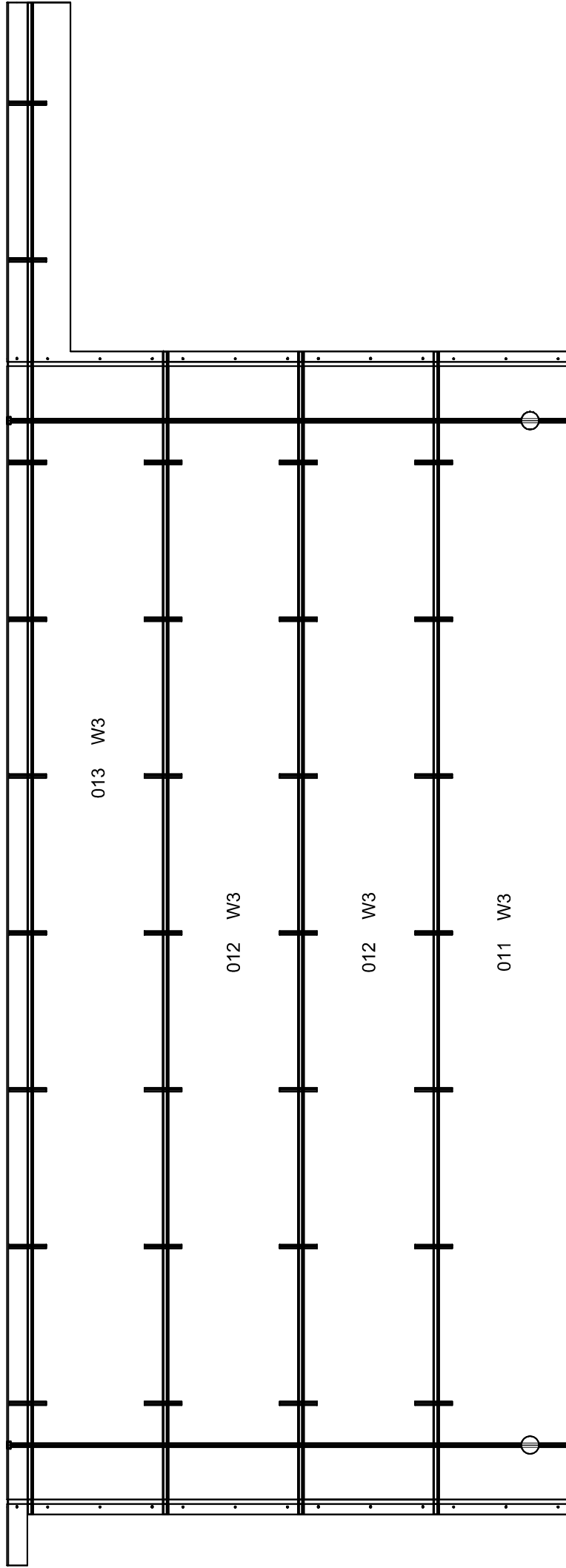

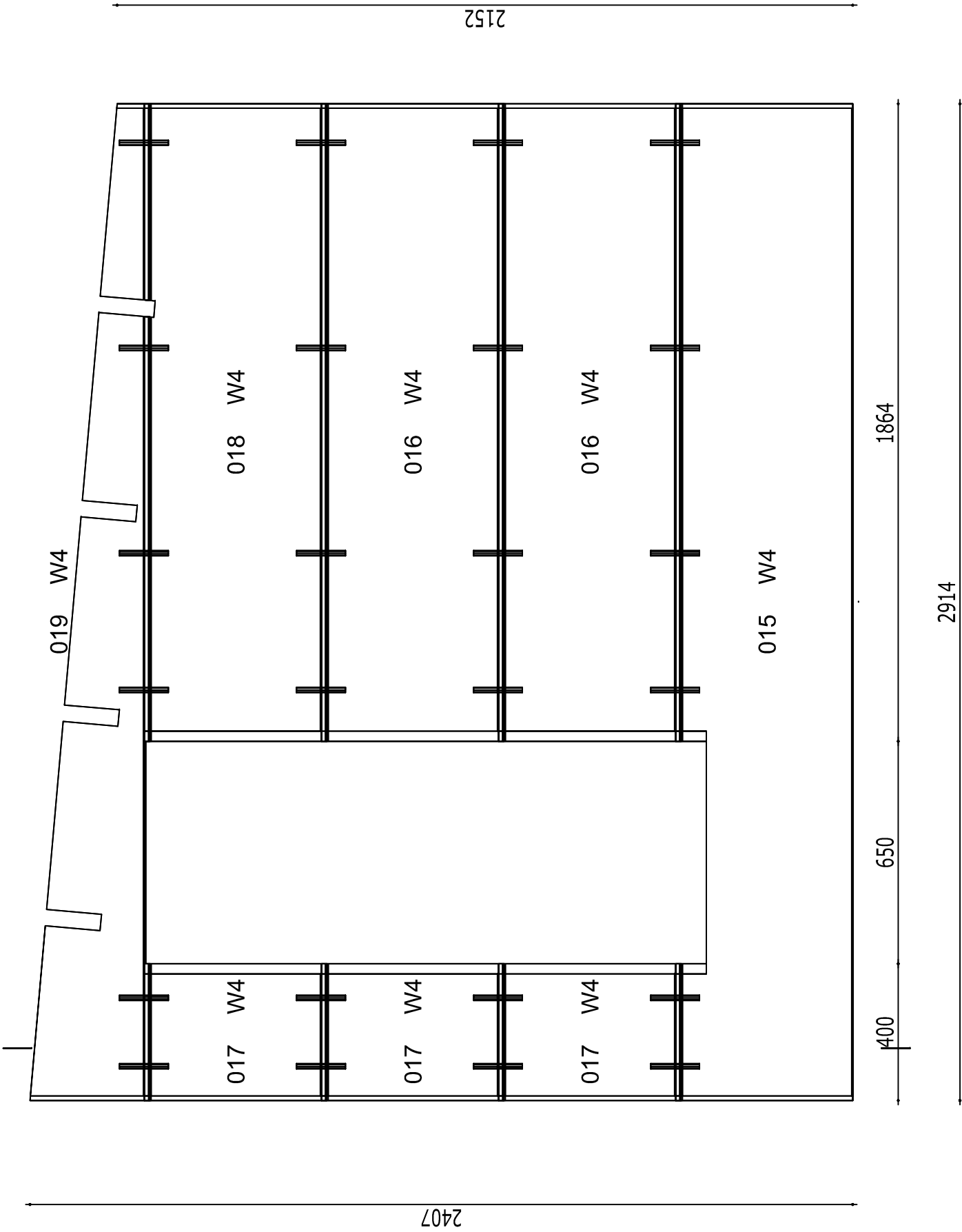

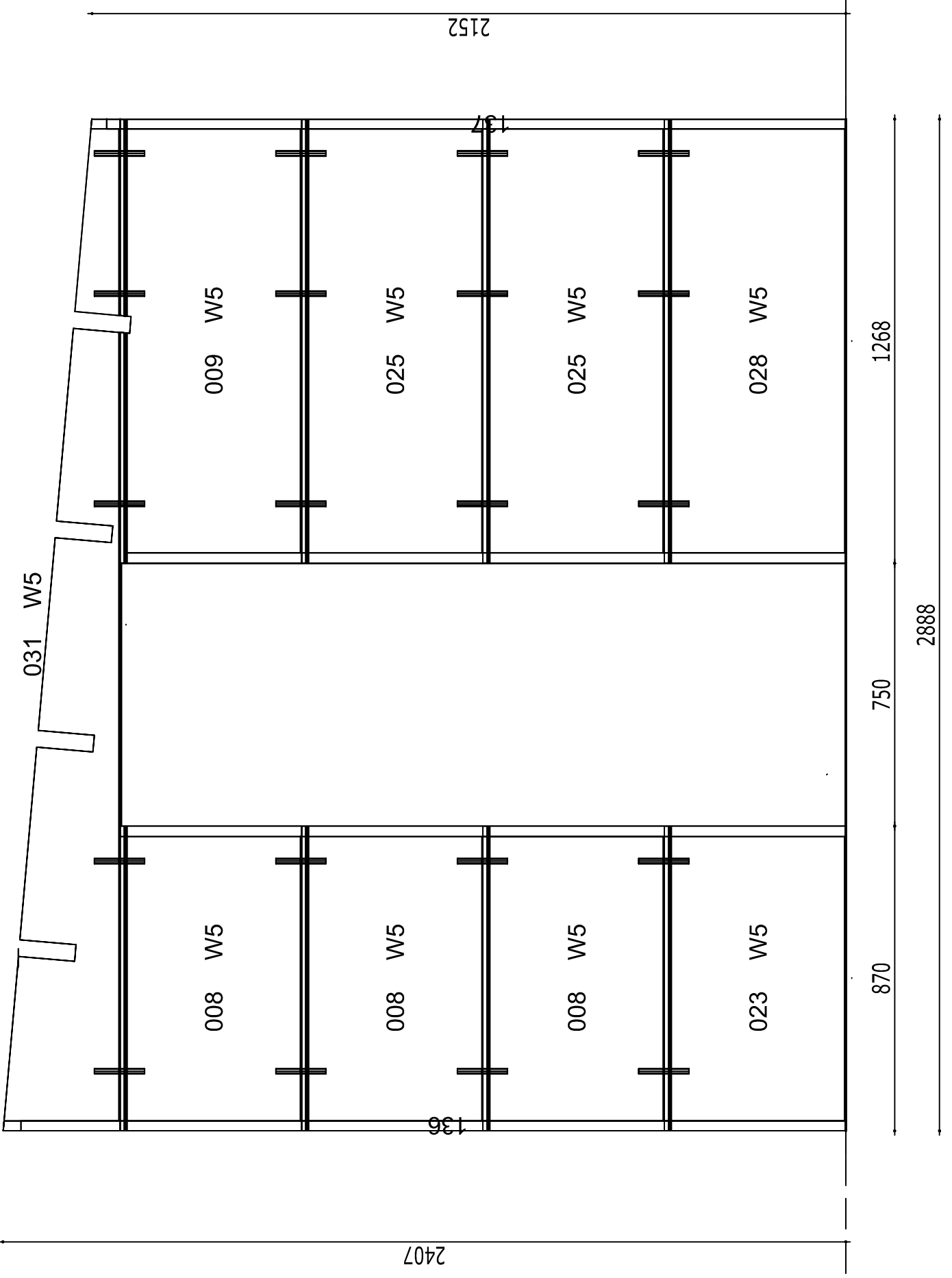

2407

136

008 W5

008 W5

008 W5

023 W5

870

031 W5

009 W5

025 W5

025 W5

028 W5

750

1268

2888

2152

137

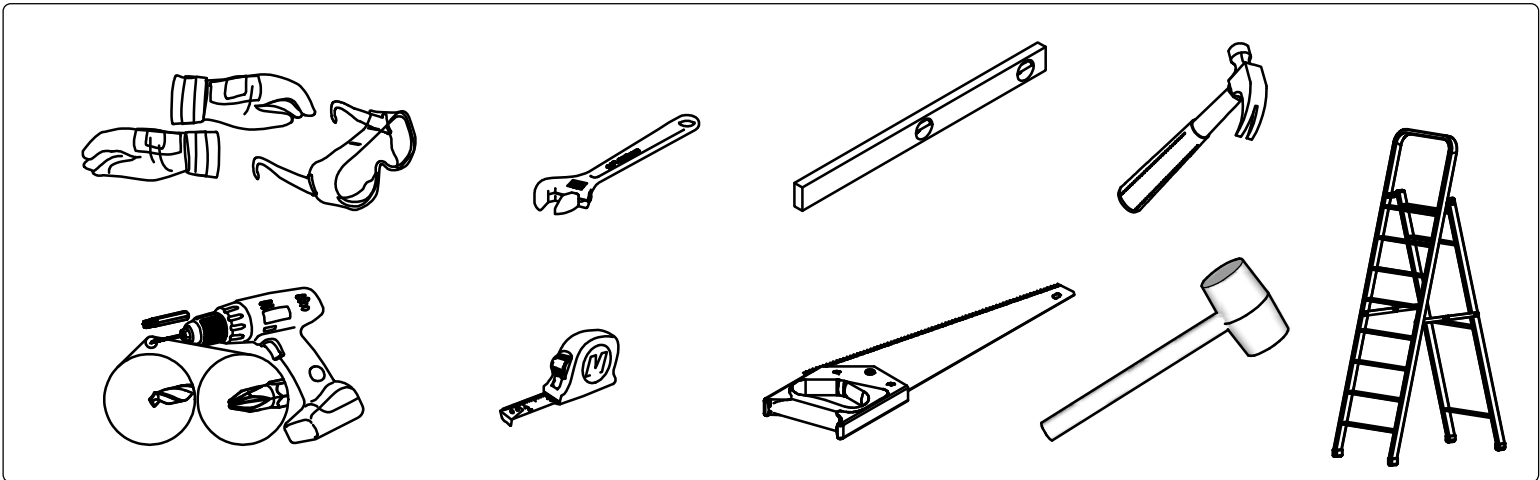
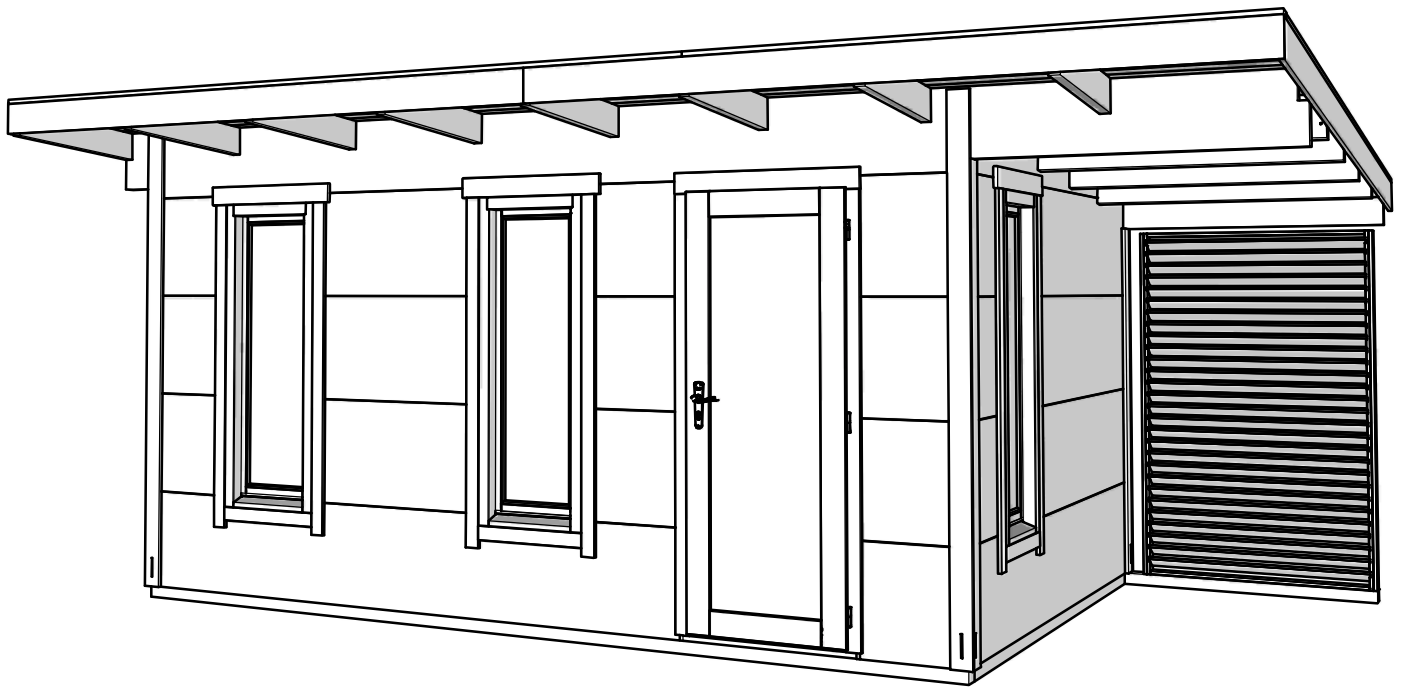

1

Plan: 1

Positions: 104, 134, 135

 20 x (QKRPP6x120ZnTx)

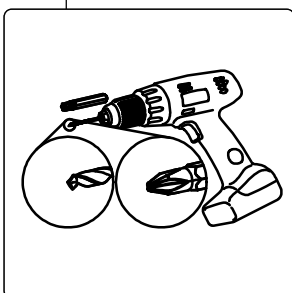
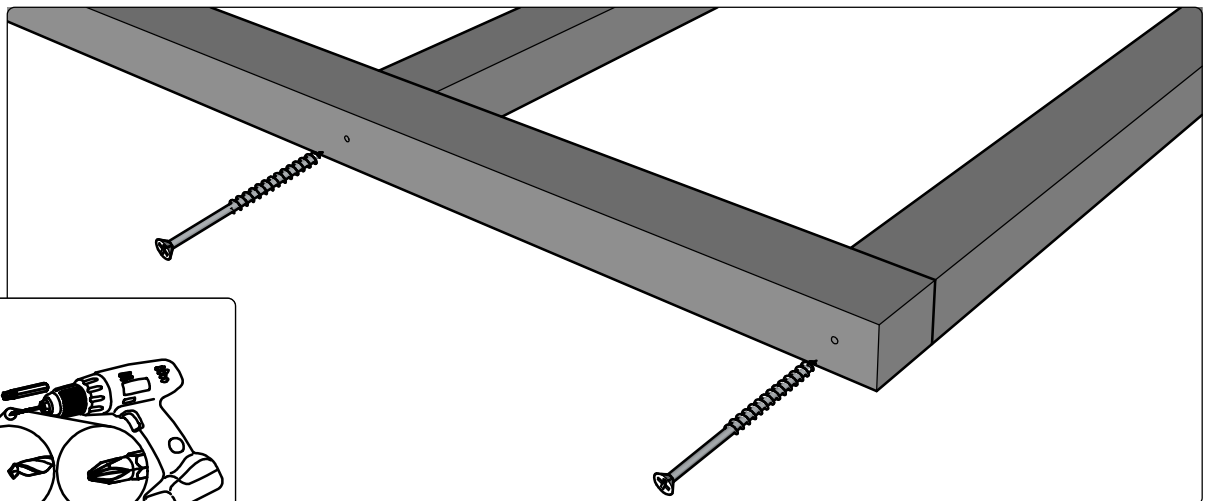
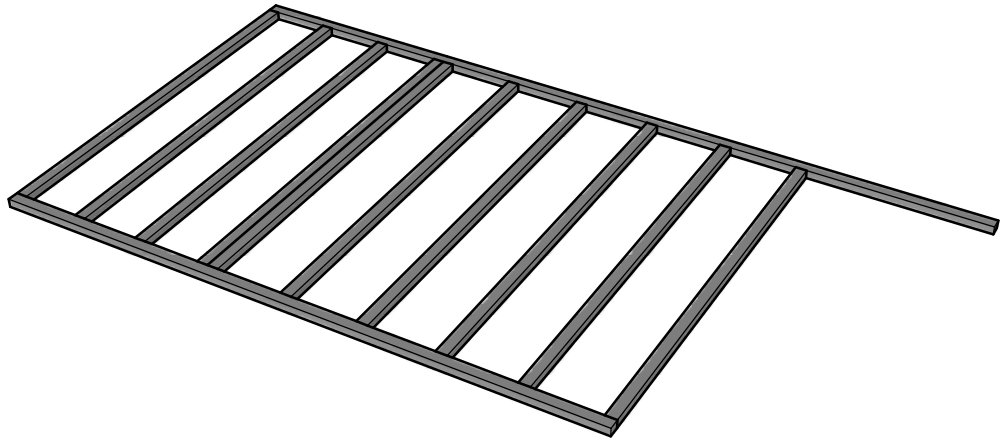
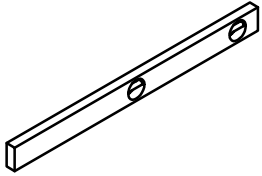

2

Positions: 001, 002, 011 , 015, 029



QT 115 - 1

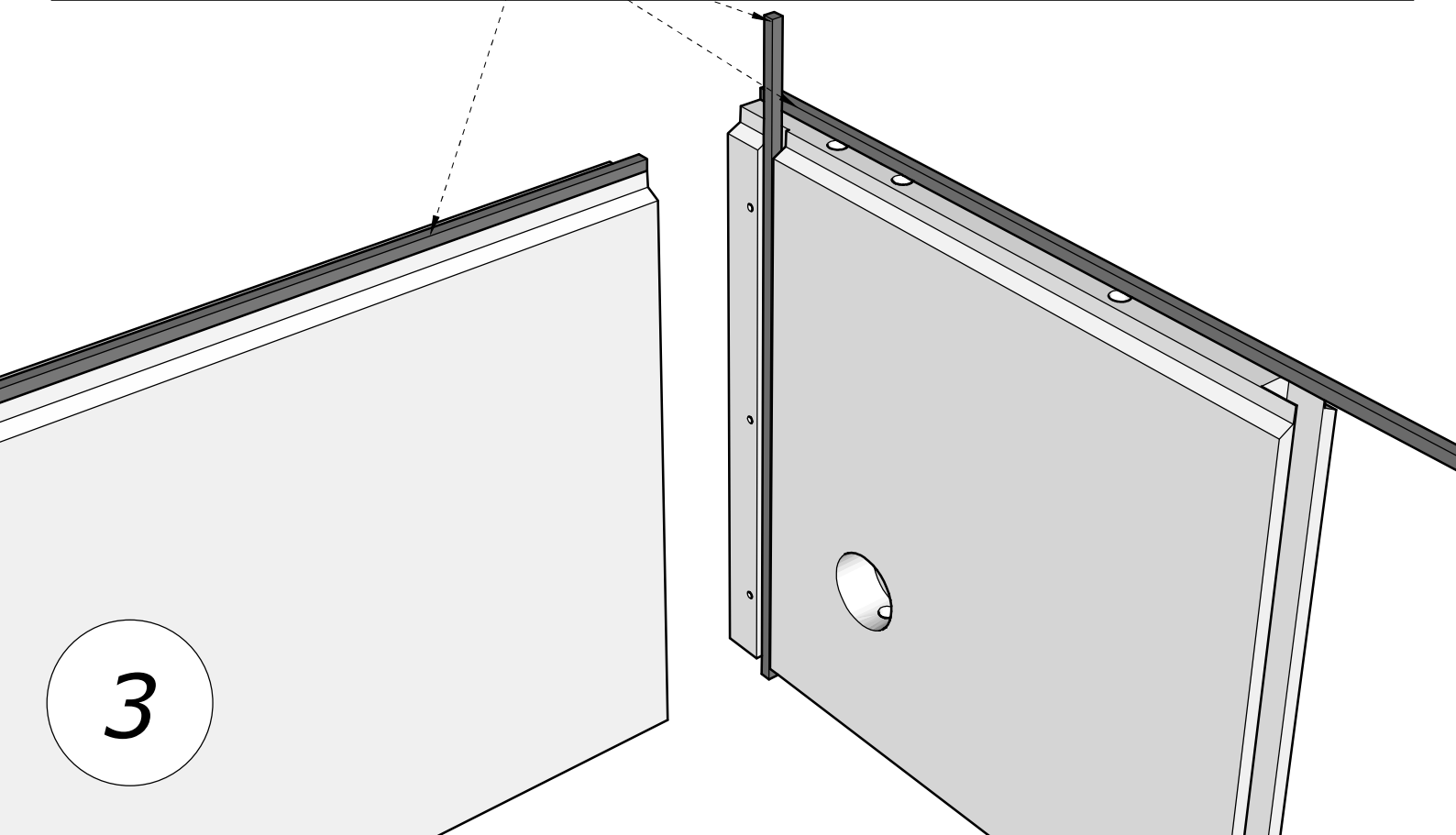
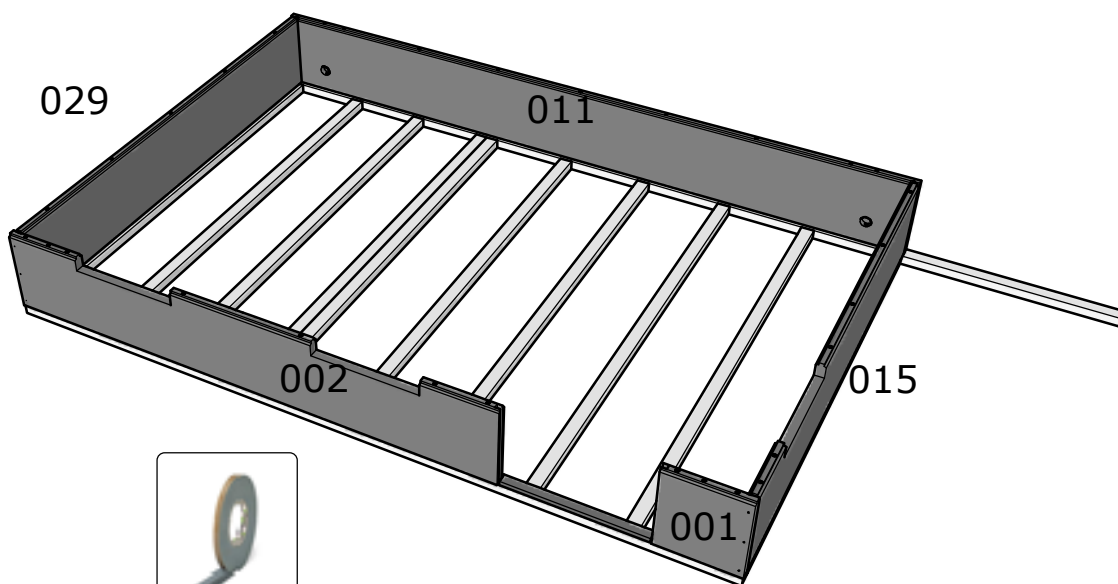

3



12 x (QKRPP6x120ZnTx)



16 x (QKRPP4_5X70Zn)

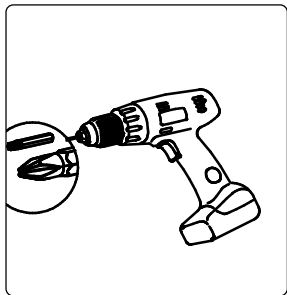
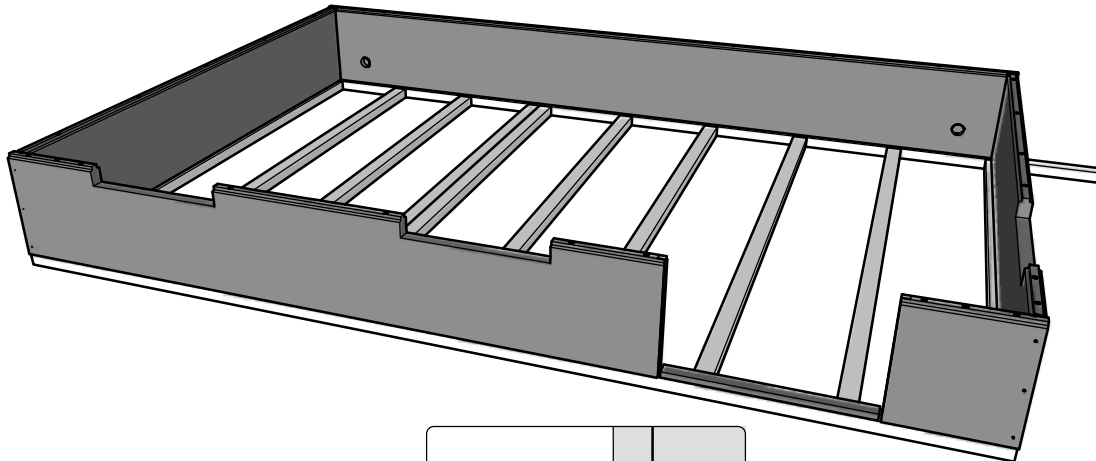

6 X 120

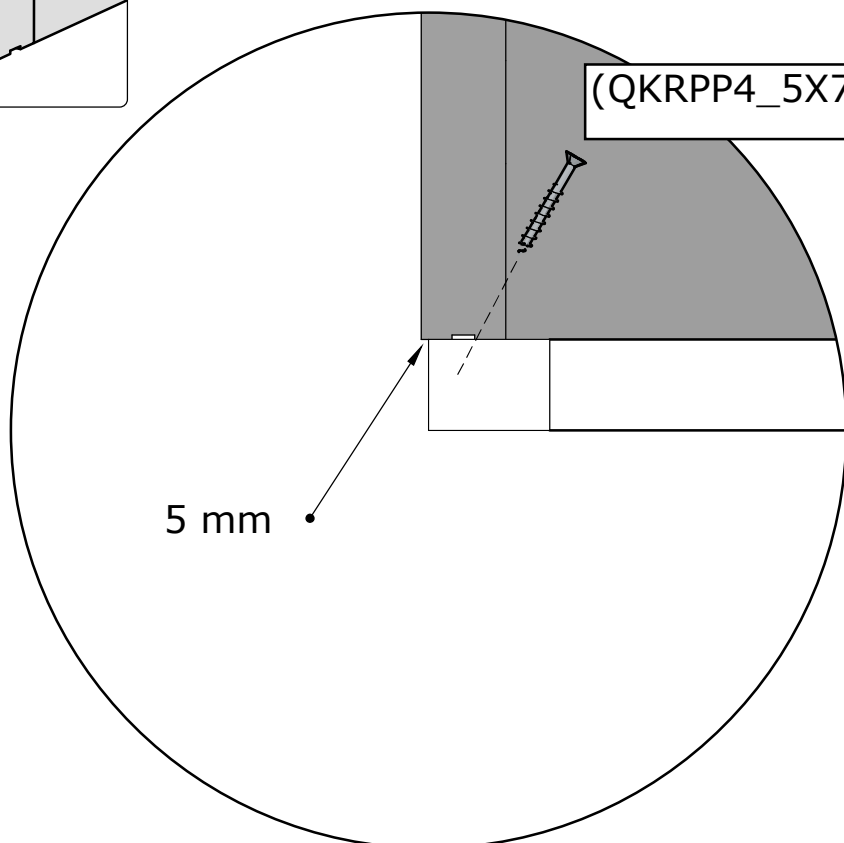
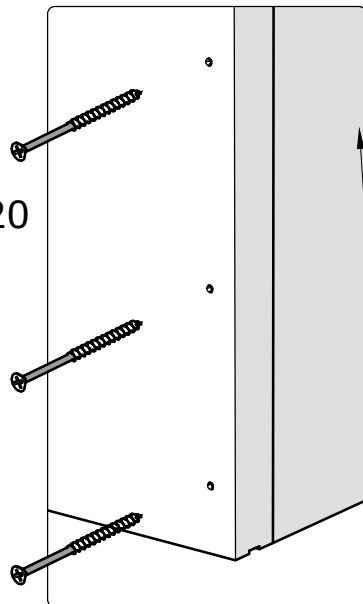

4

Positions: 023; 028; 136; 137



22 x (QTY16x130)



6 x (QKRPP4_5X70Zn)

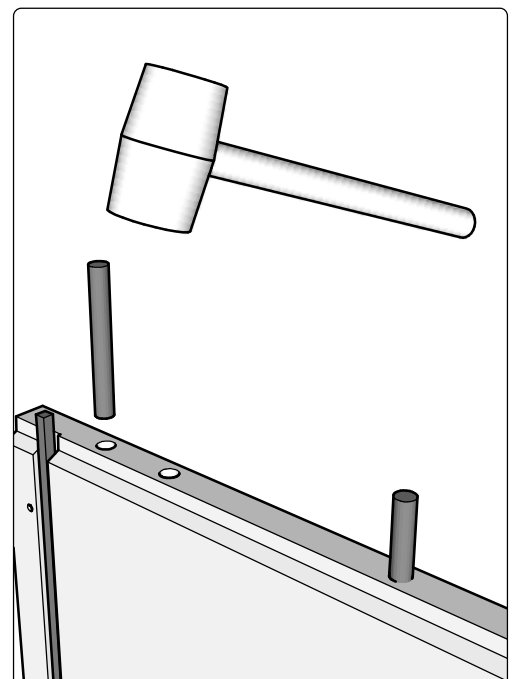
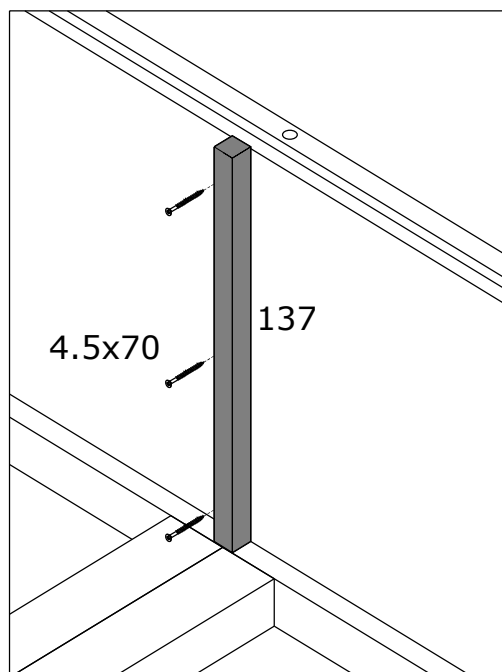
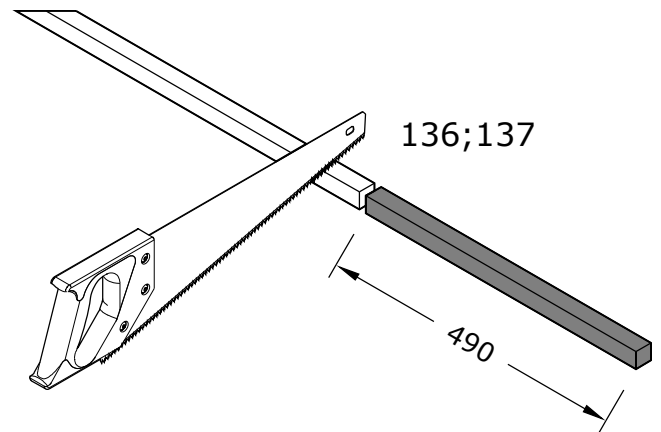
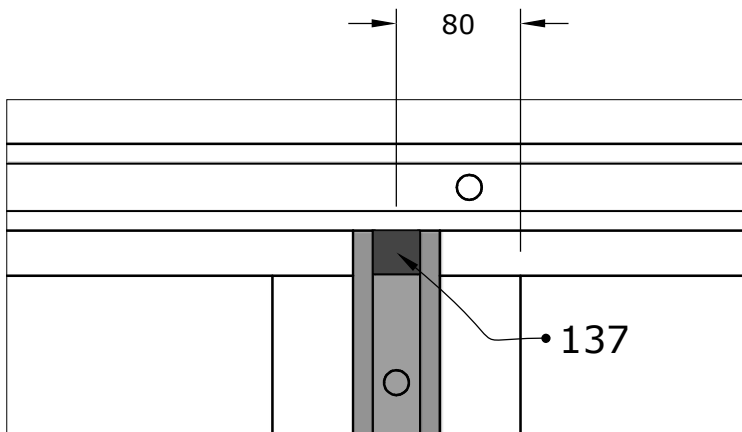
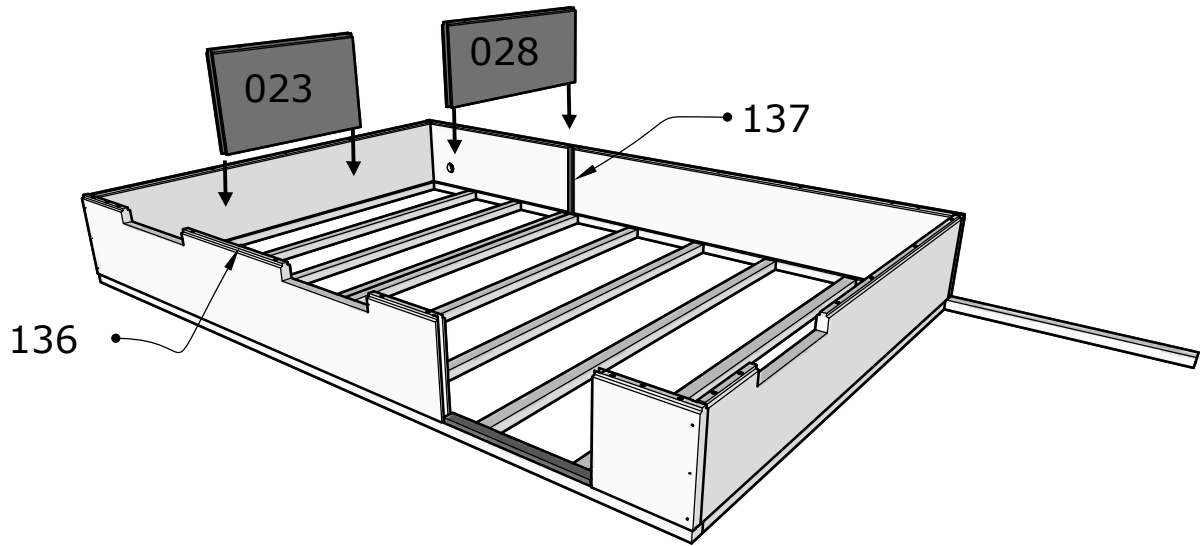

5



68 x (QTY16x130)

Positions: 003, 004, 005, 008, 012, 013, 016, 017, 018, 025, 026, 030, 032



36 x (QKRPP6x120Zn)



QT 115 - 1

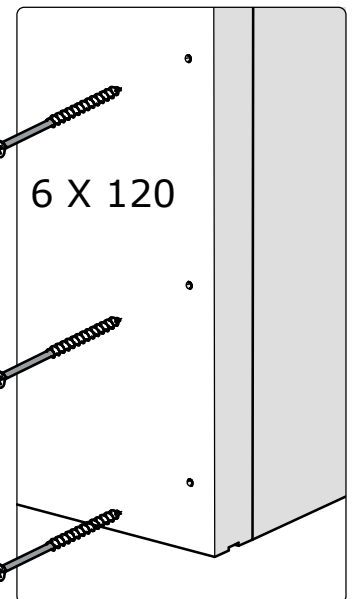
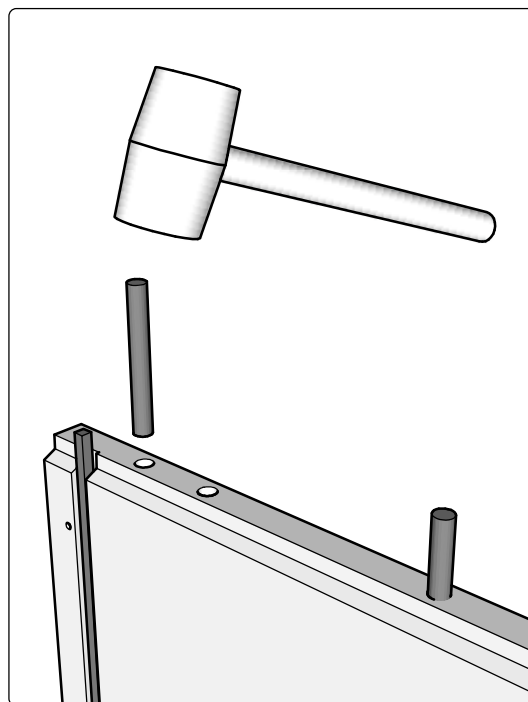
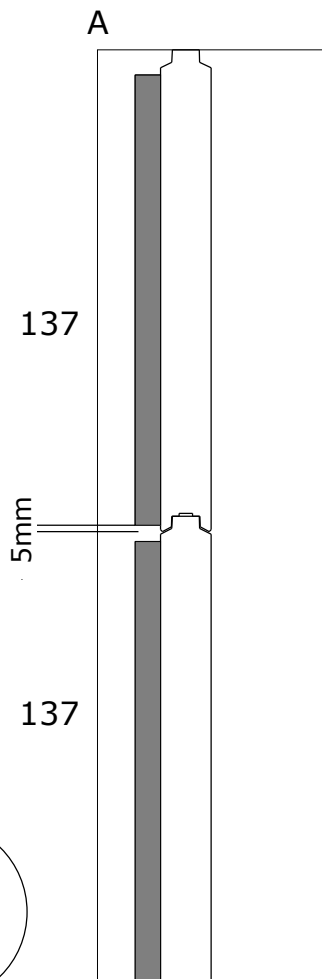
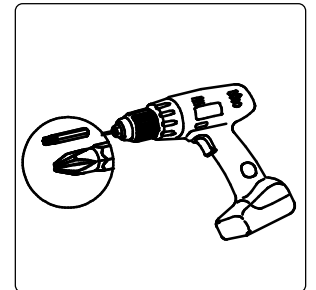
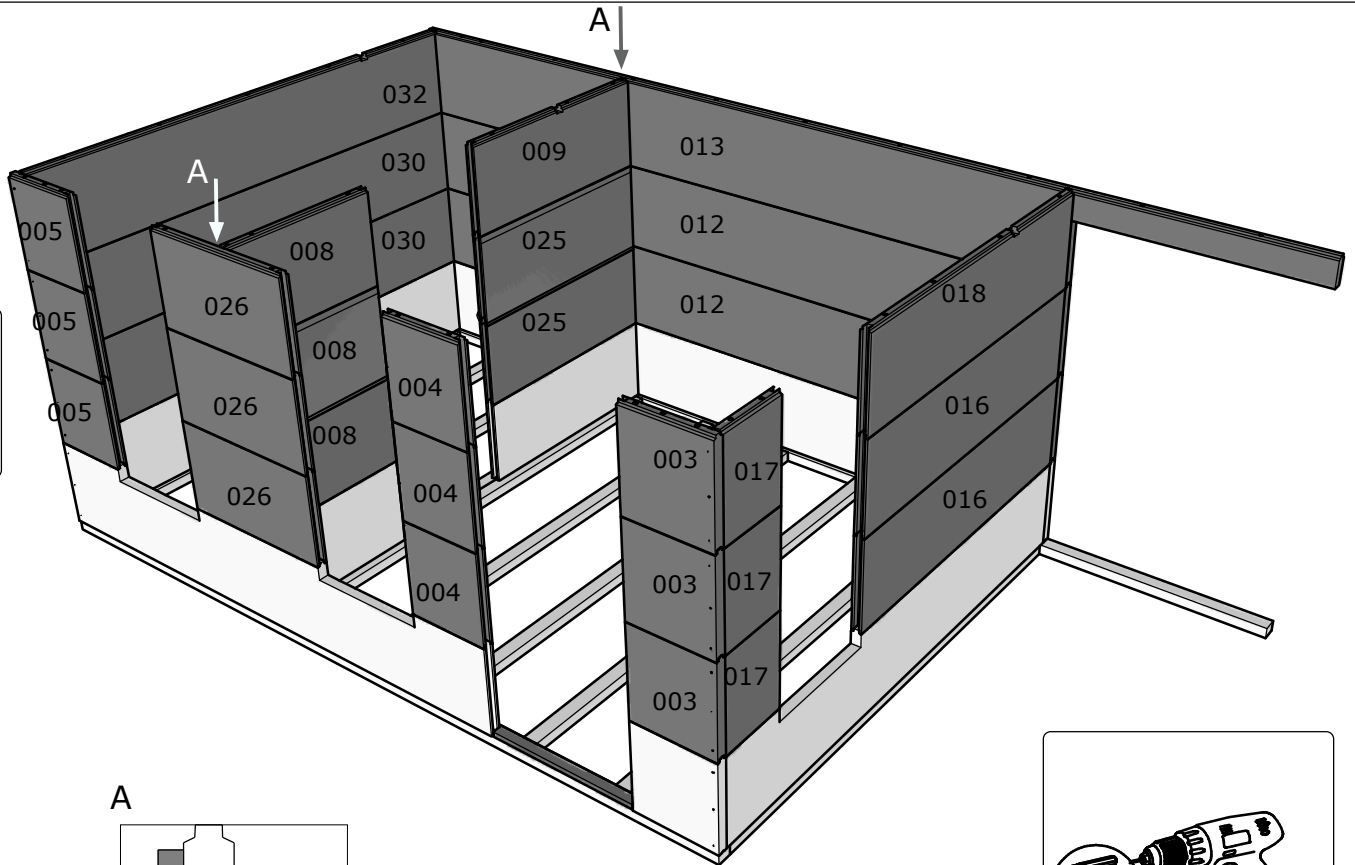

6

Plan: 2, 3, 4, 5, 7

Positions: 006, 010, 014, 019, 031

 10 x (QKRPP6x120Zn)

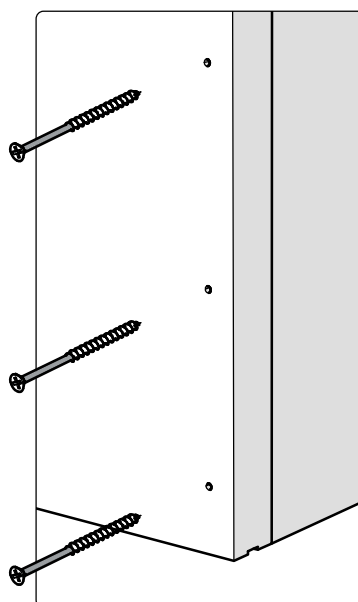
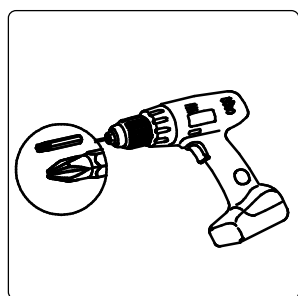
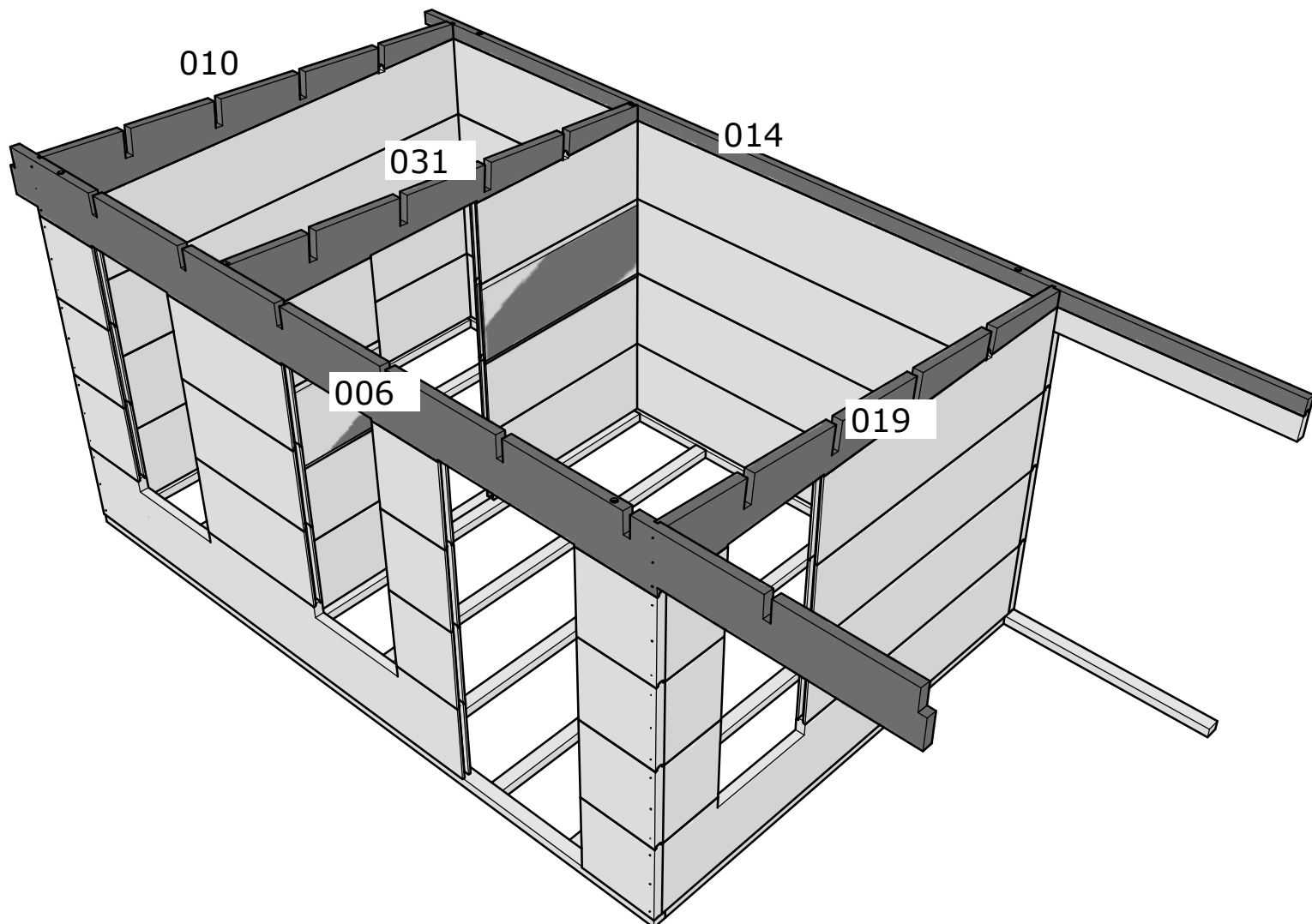

7

Plan:  (QKE8x2000) X 4 & (QKE8x300) X 2

Positions:

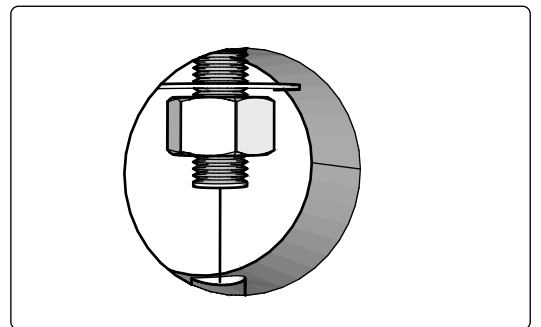
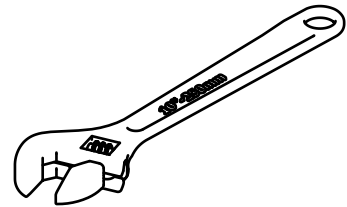
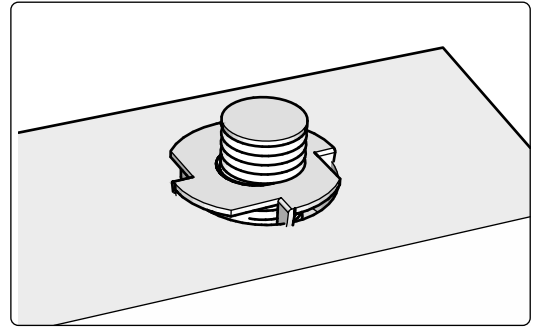
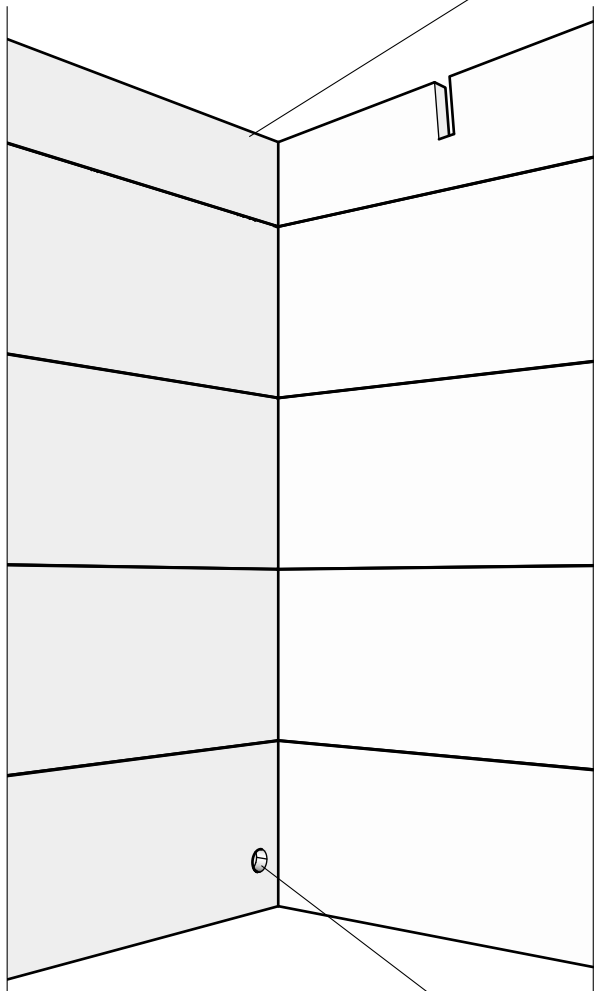
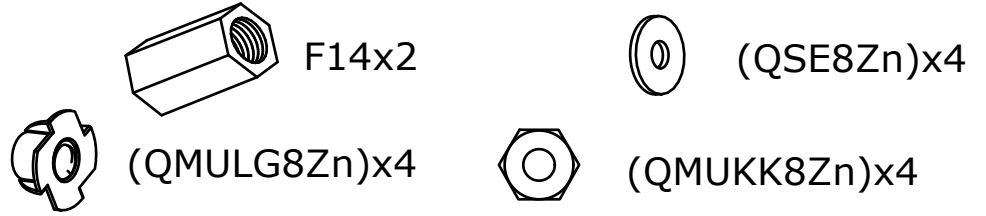

Positions: 121, 122



40x(QKRPP6x120ZnTx)

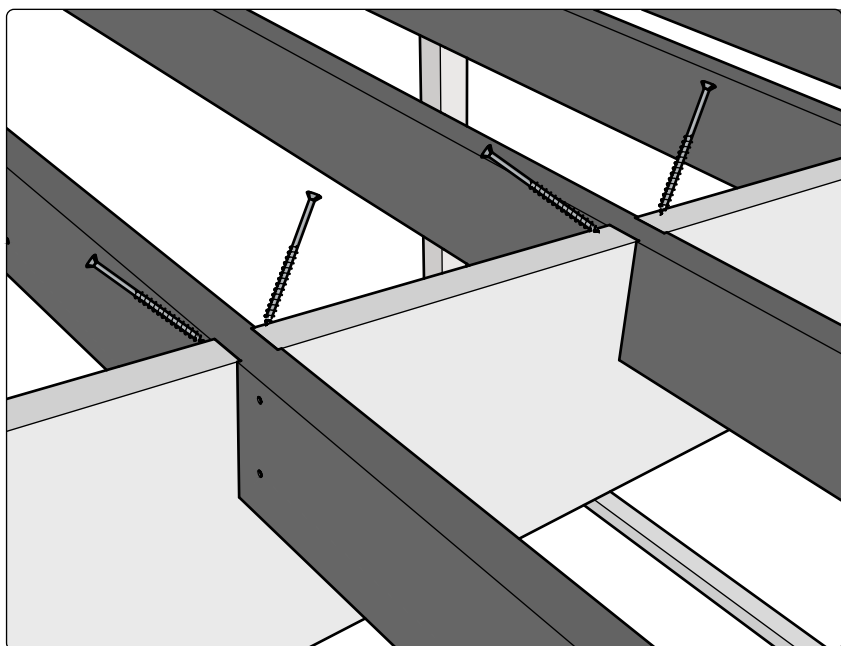
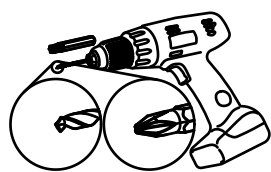
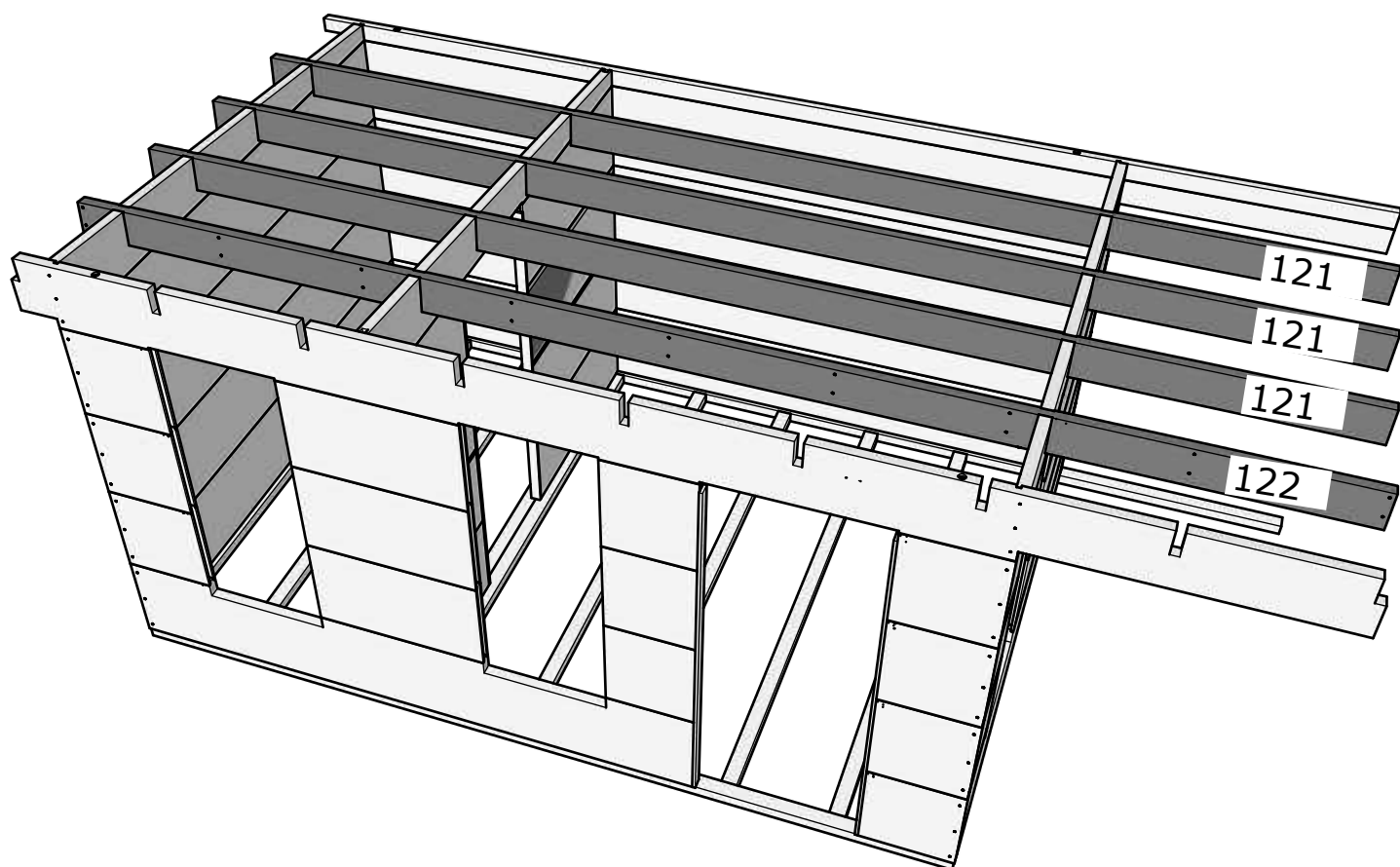

9

Positions: 112, 116, 117



18 x (QKRPP6x120Zn)

117

116

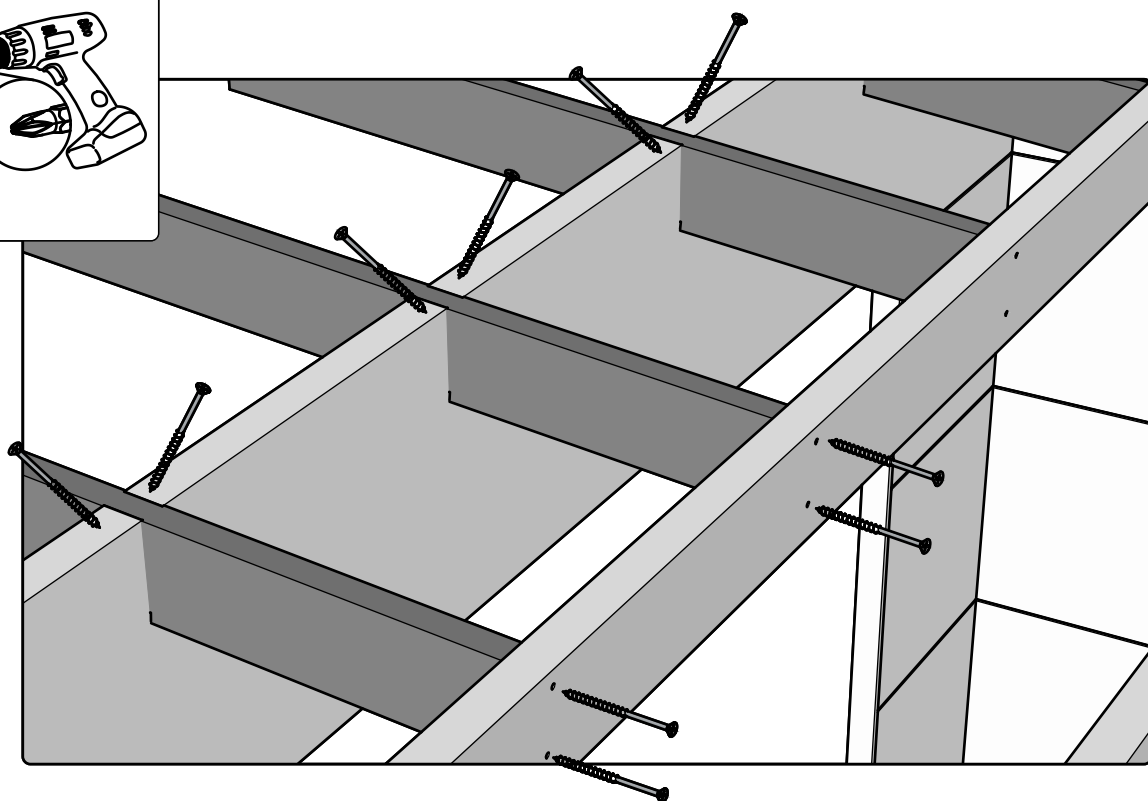
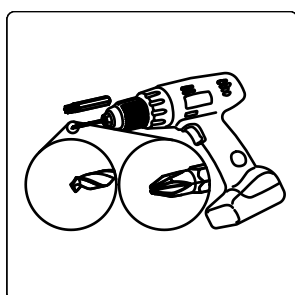
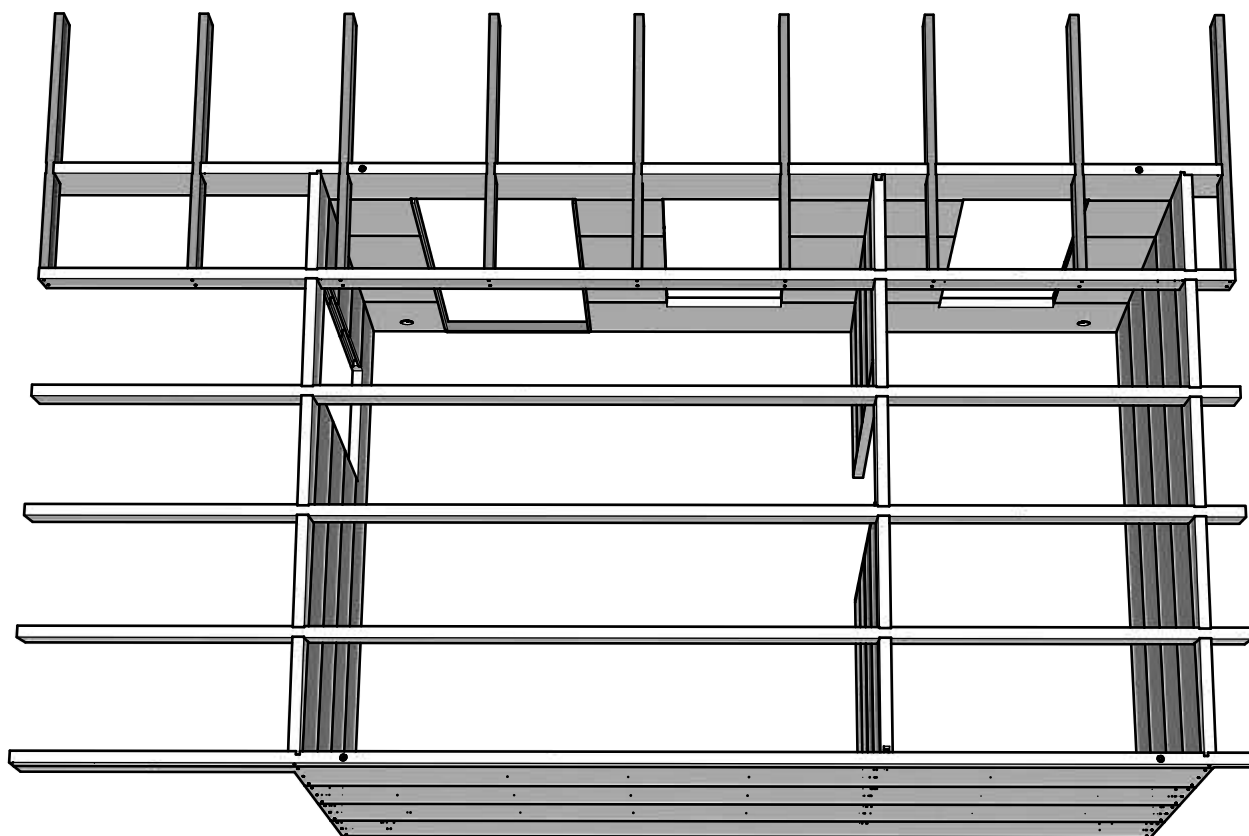

10

Plan:

Positions: 100, 107, 110

 550 x (QNA2_2x50Zn)

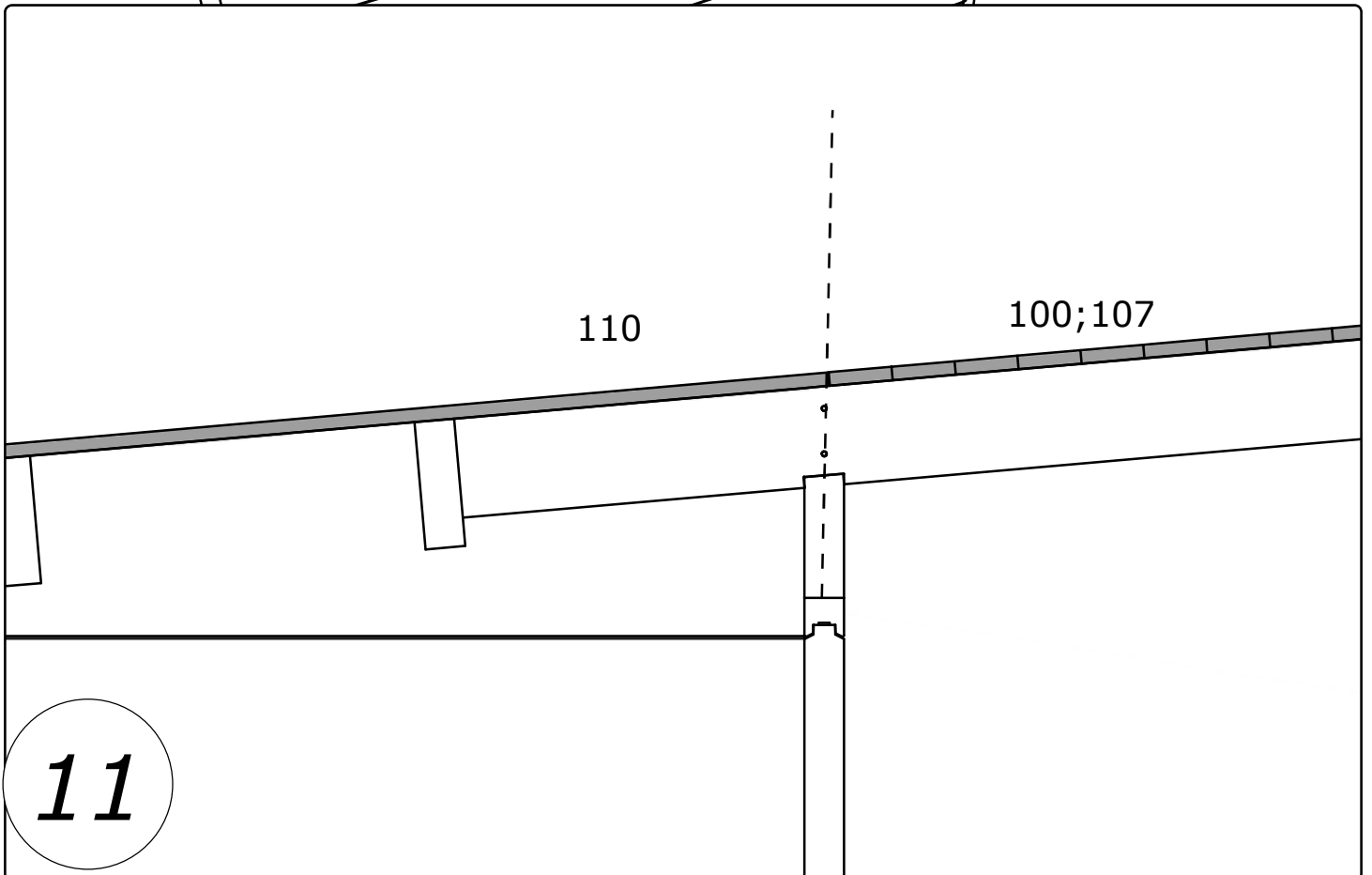
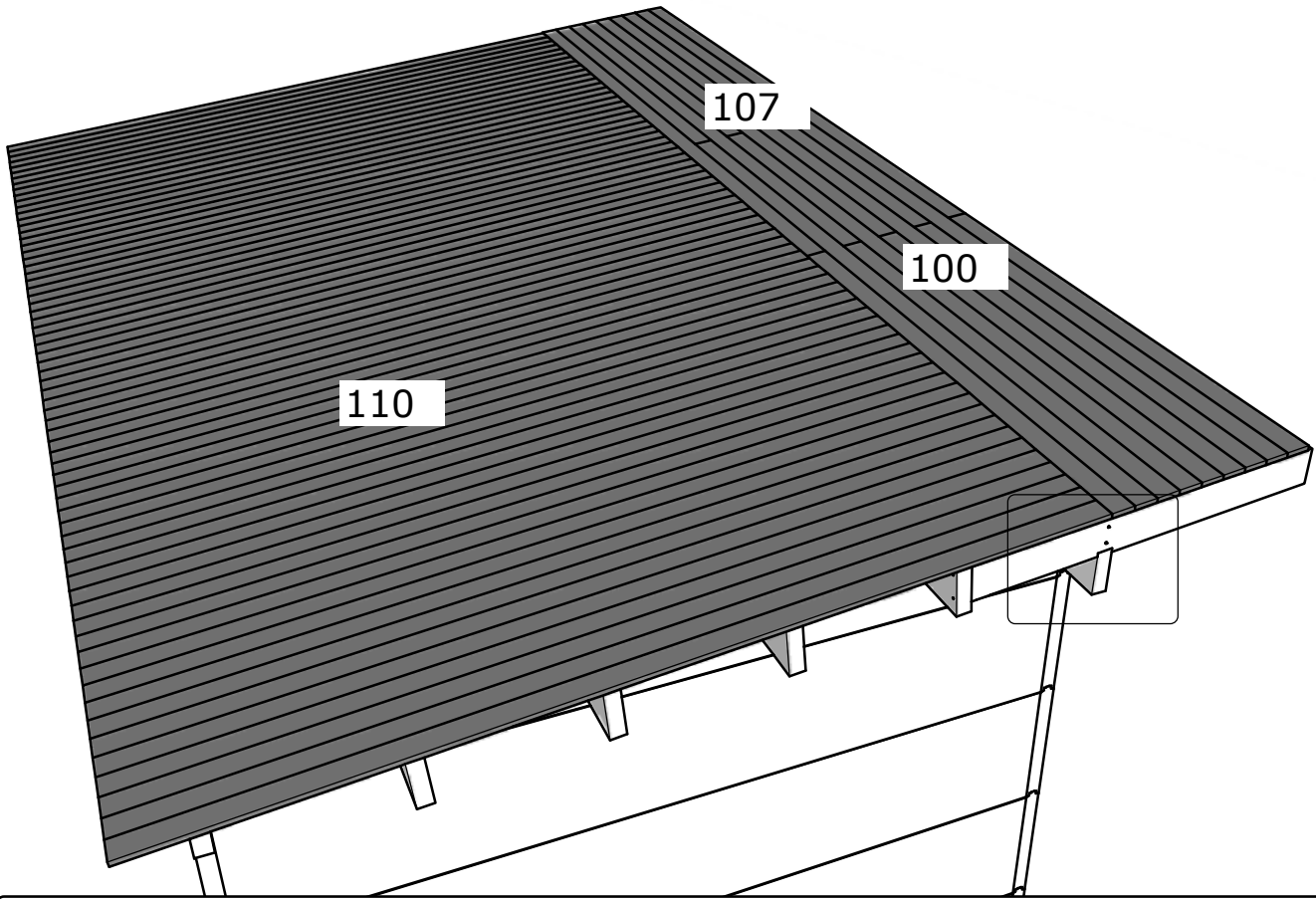

Positions: 100, 107

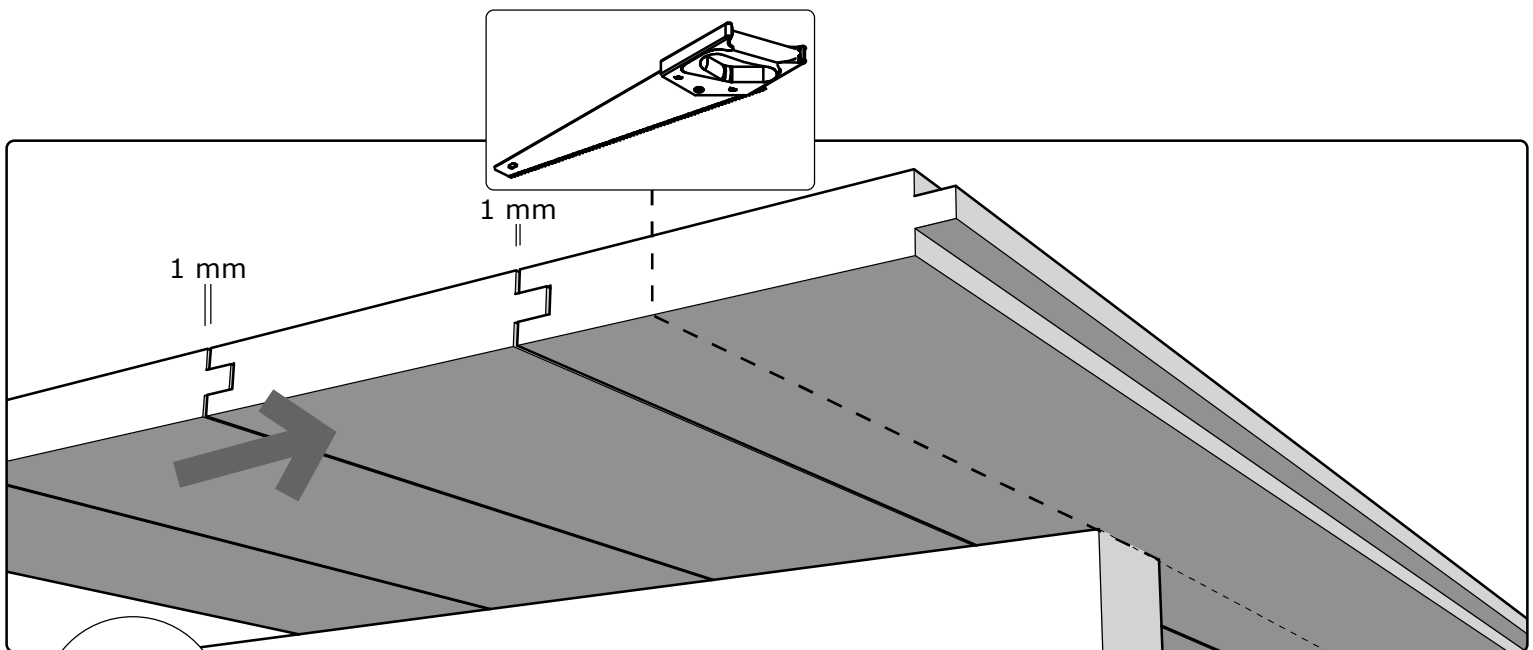
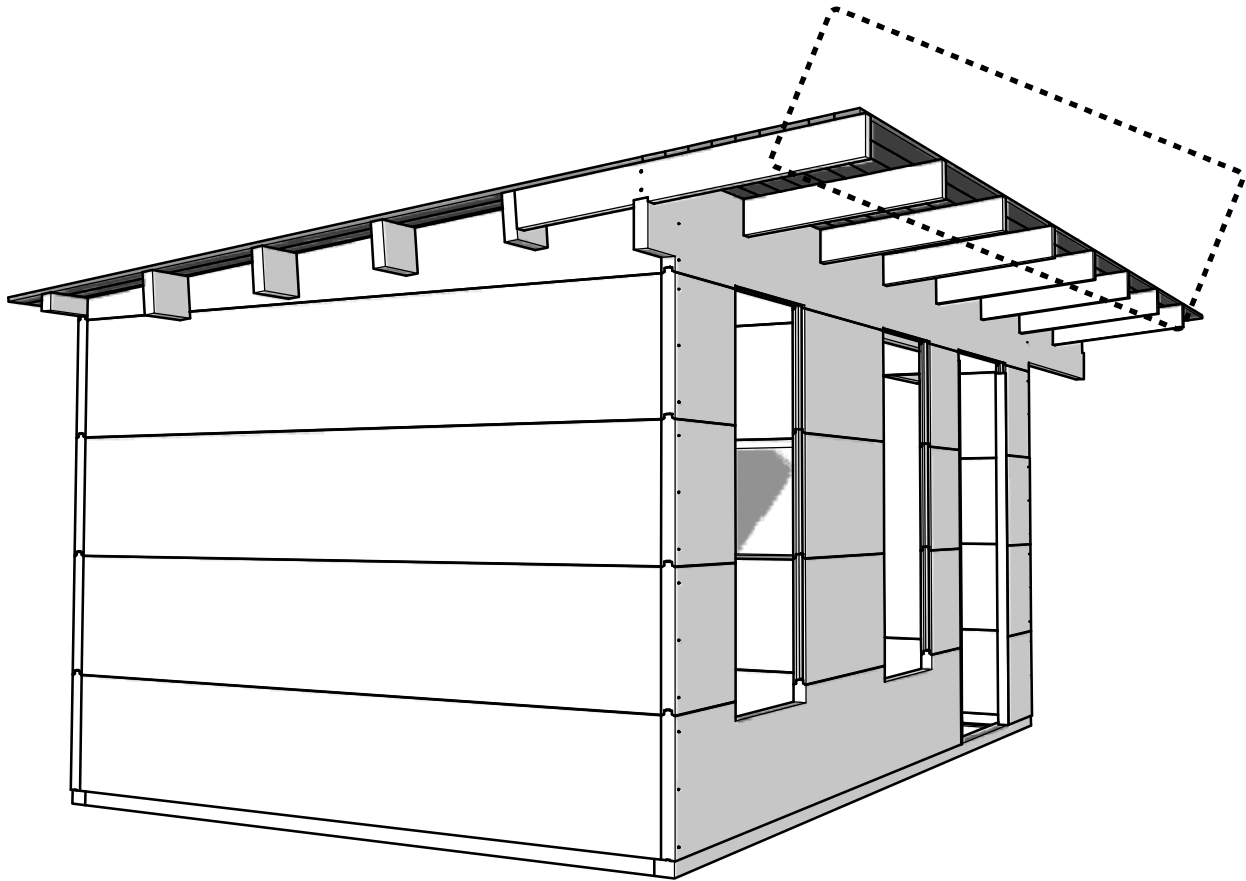

Plan:

Positions: 110

 360 x (QNA2_2x50Zn)

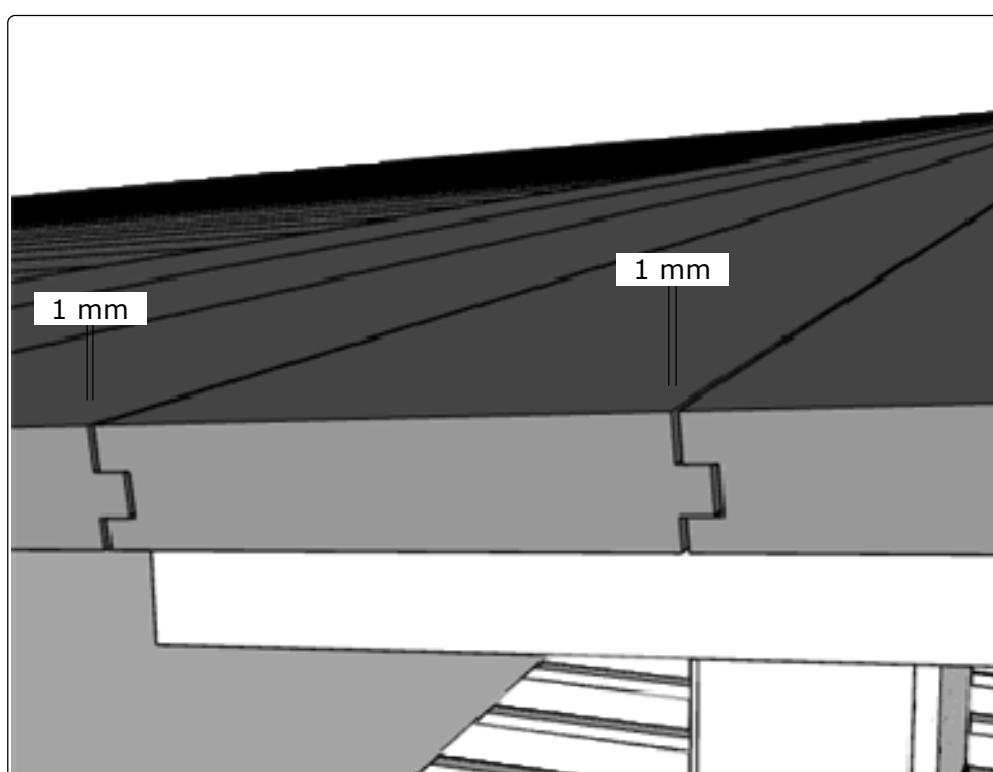
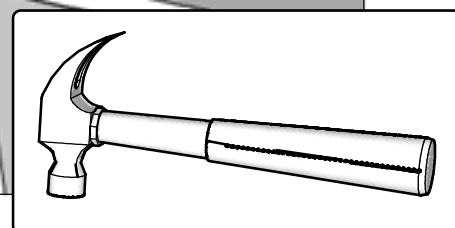
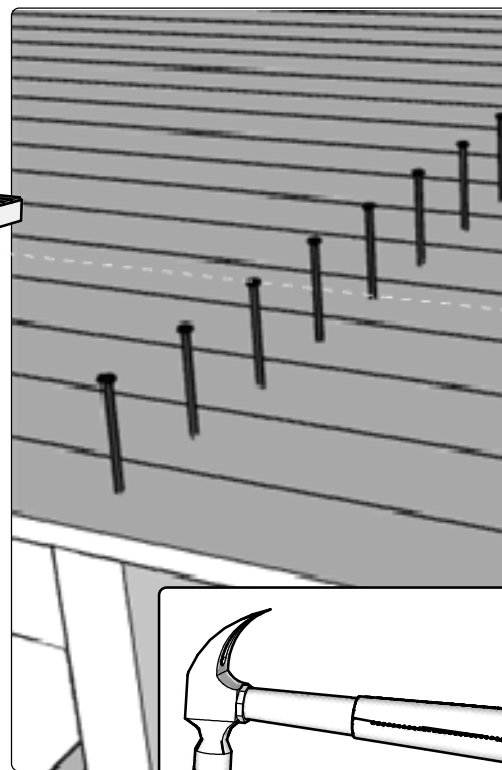
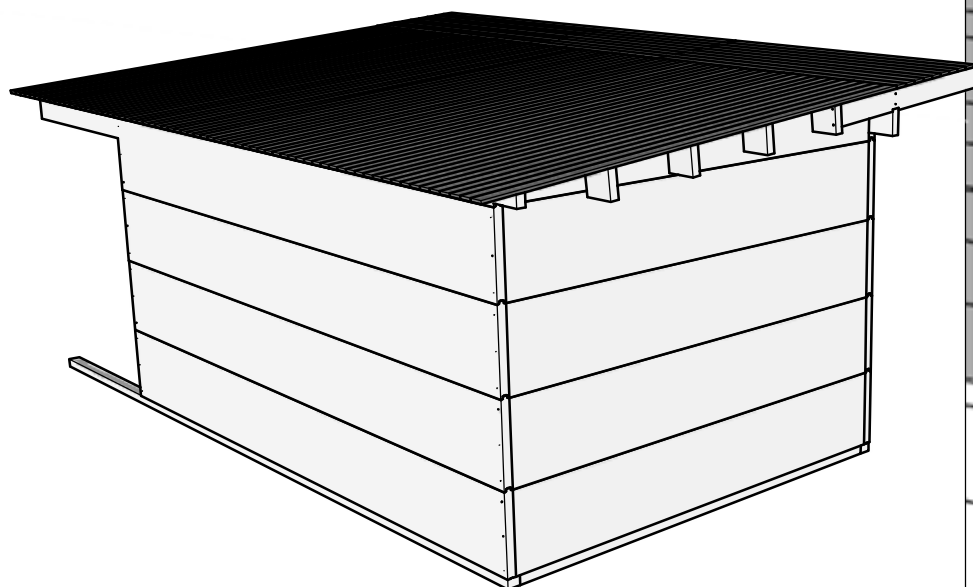

Plan:

Positions: 110

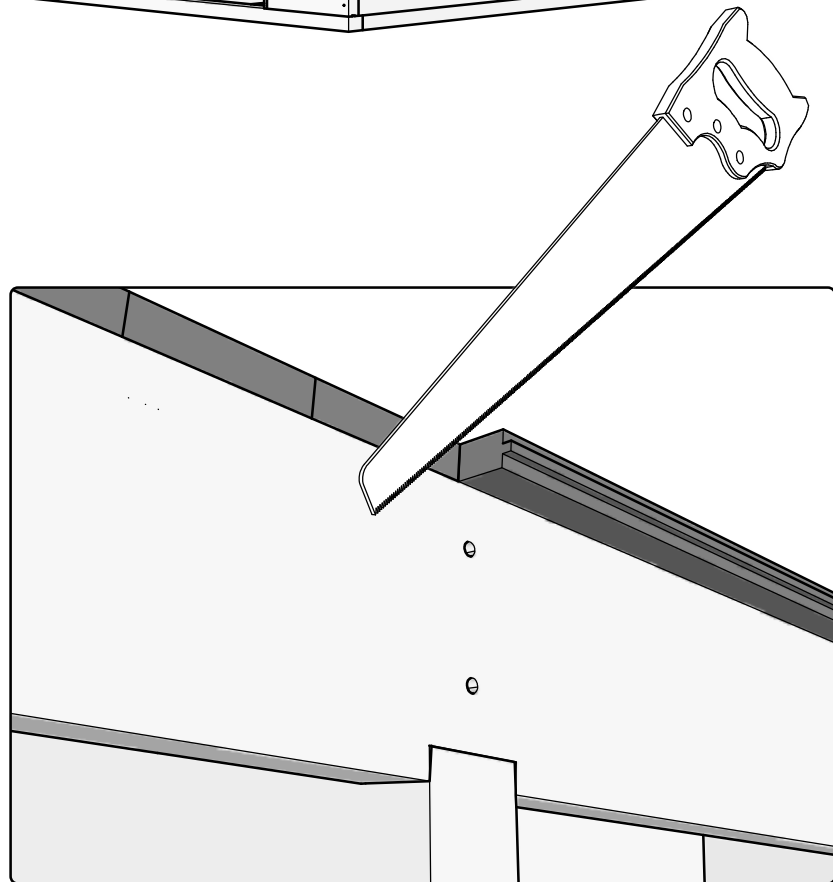
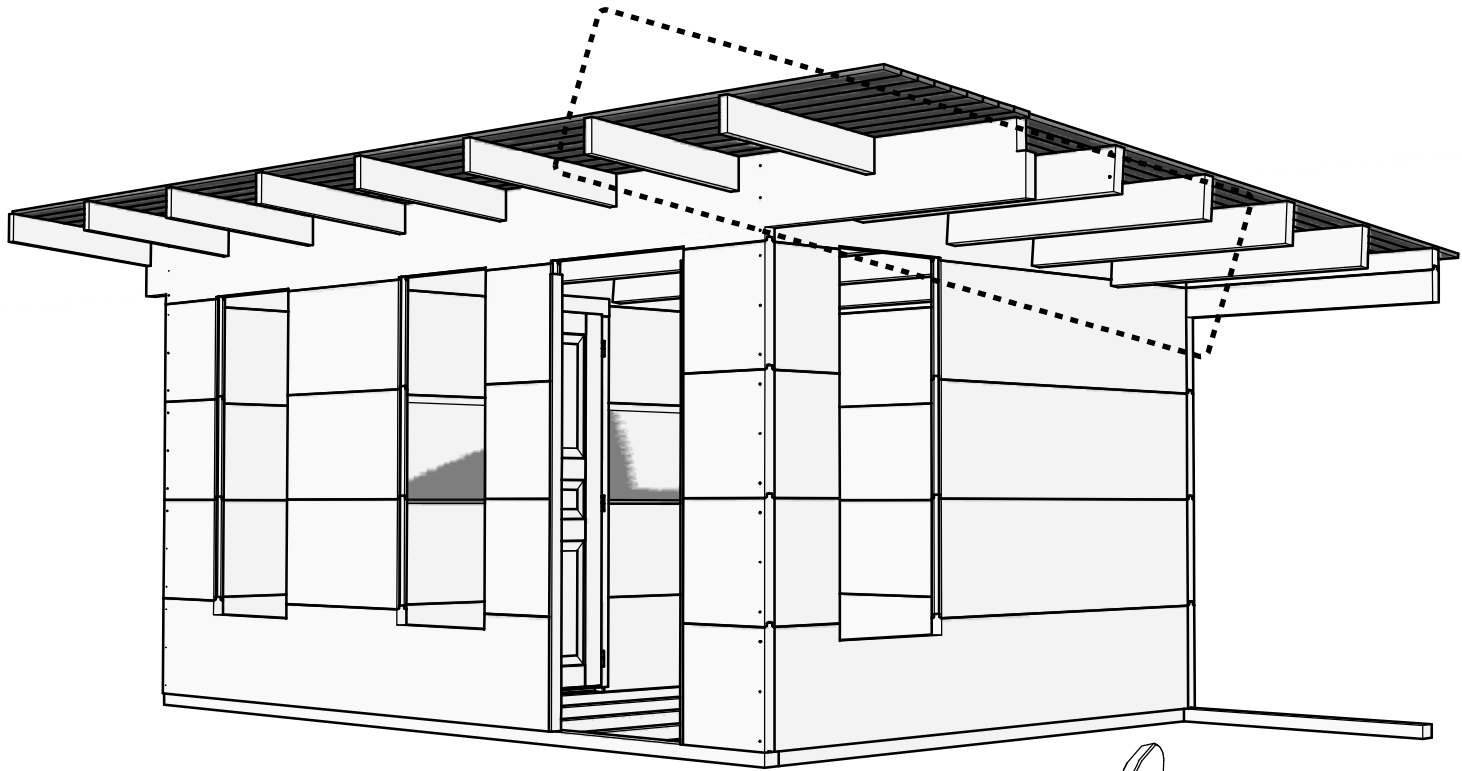

Plan:

Positions: 109



12 x (QKRPP4_5x50Zn)

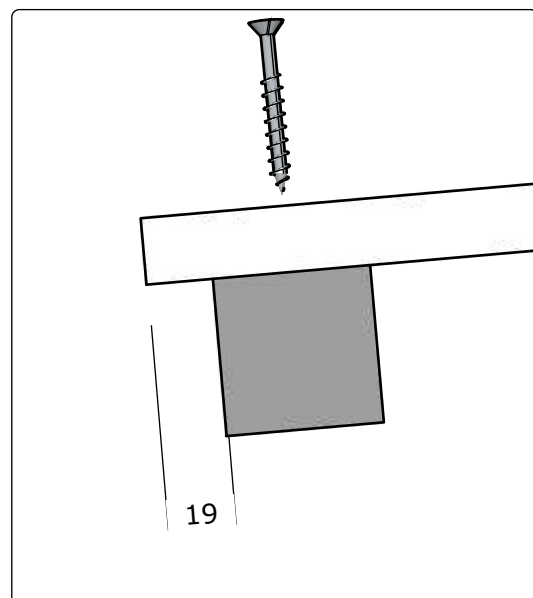
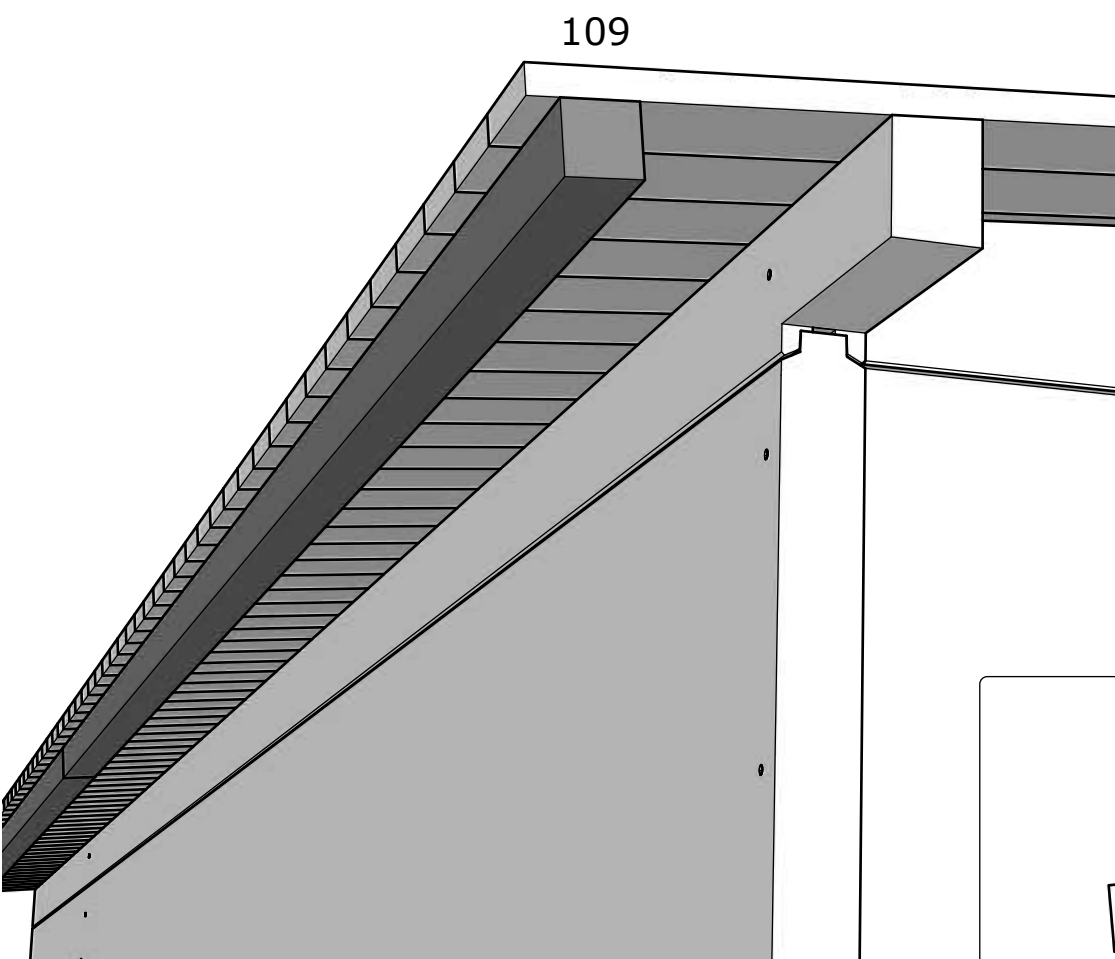
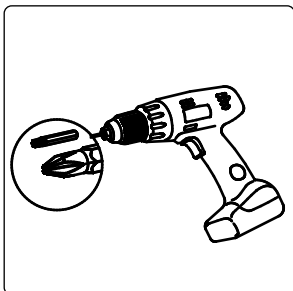

Plan:

Positions: 108; 113



12 x (QKRPP4_5x50Zn)

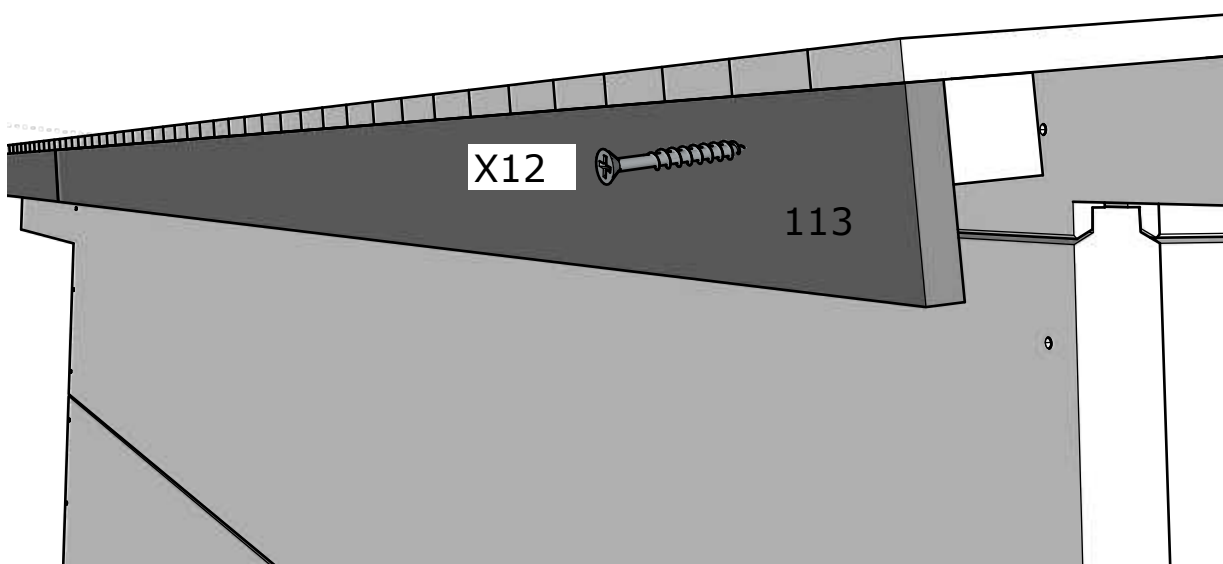
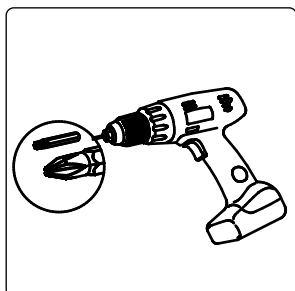

Plan:

Positions: 115, 120

 44 x (QKRPP4_5x50Zn)

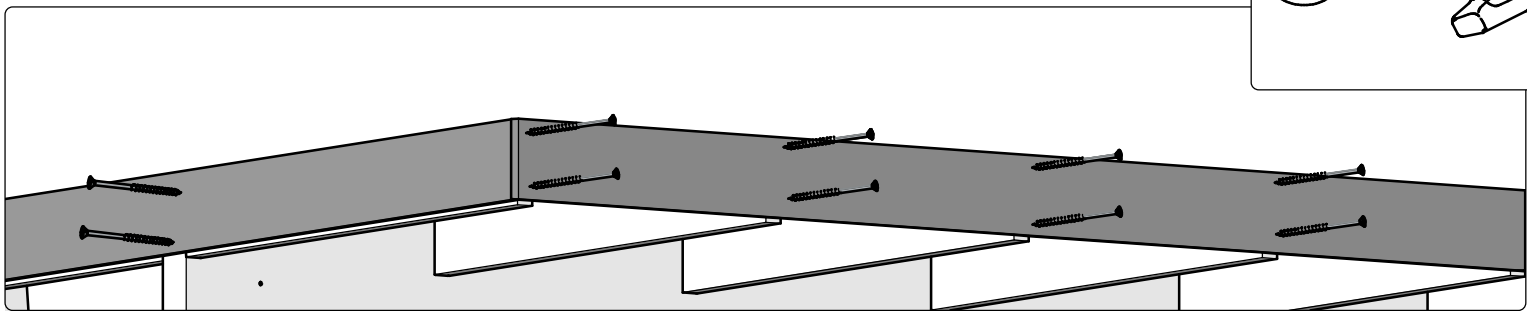
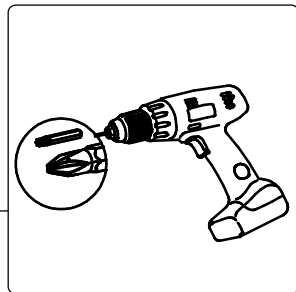
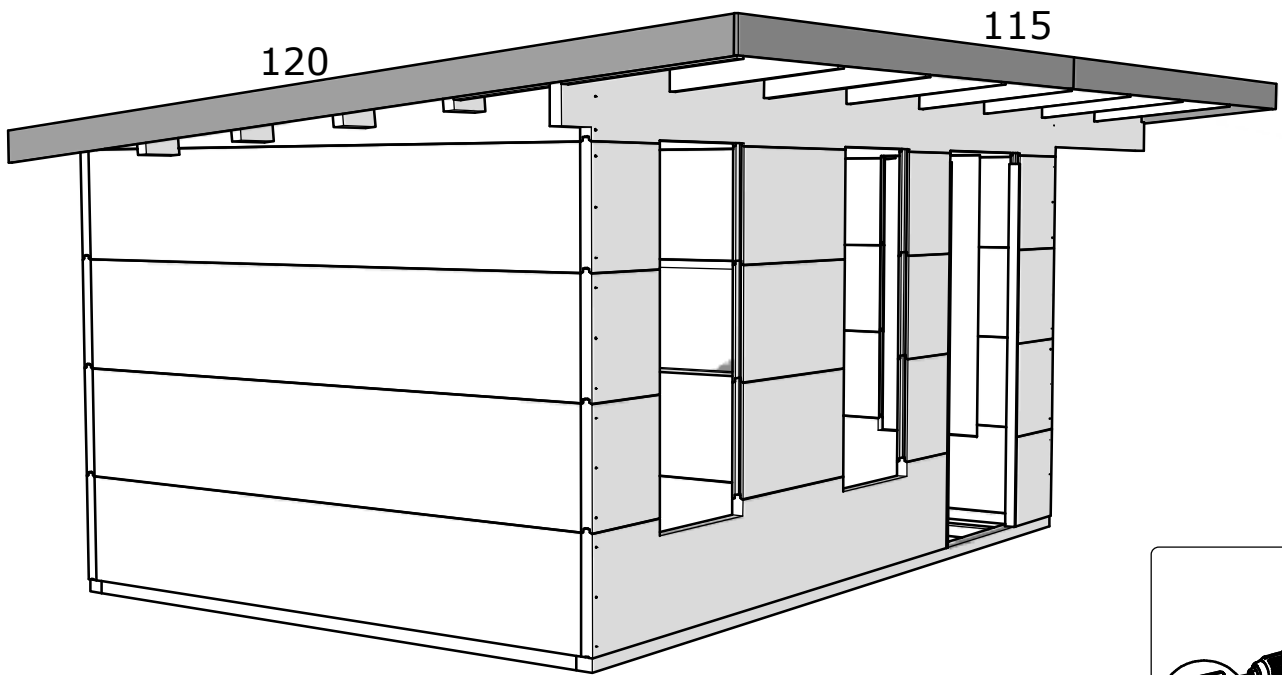

Plan:

Positions: 114, 118, 119

 16 x (QKRPP4_5x50Zn)

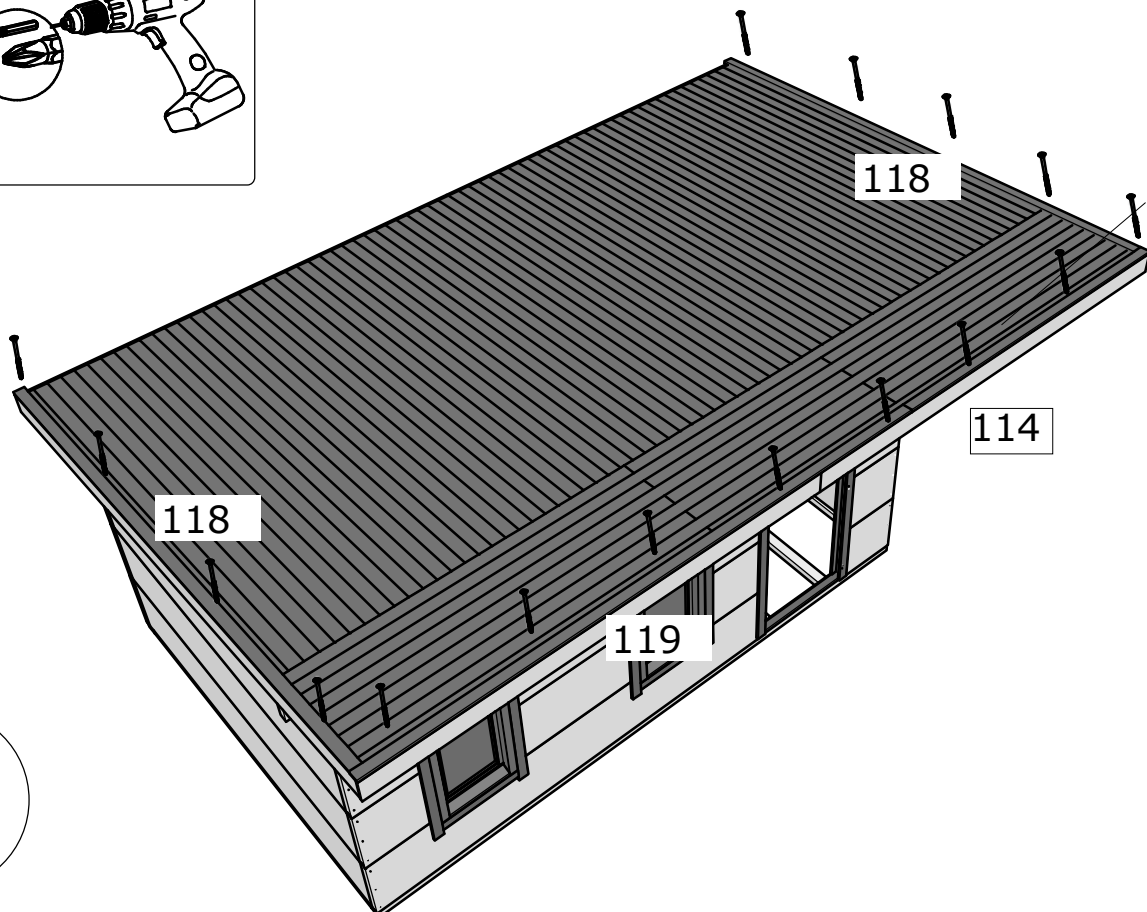
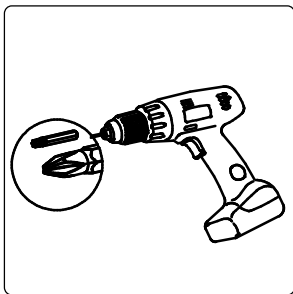
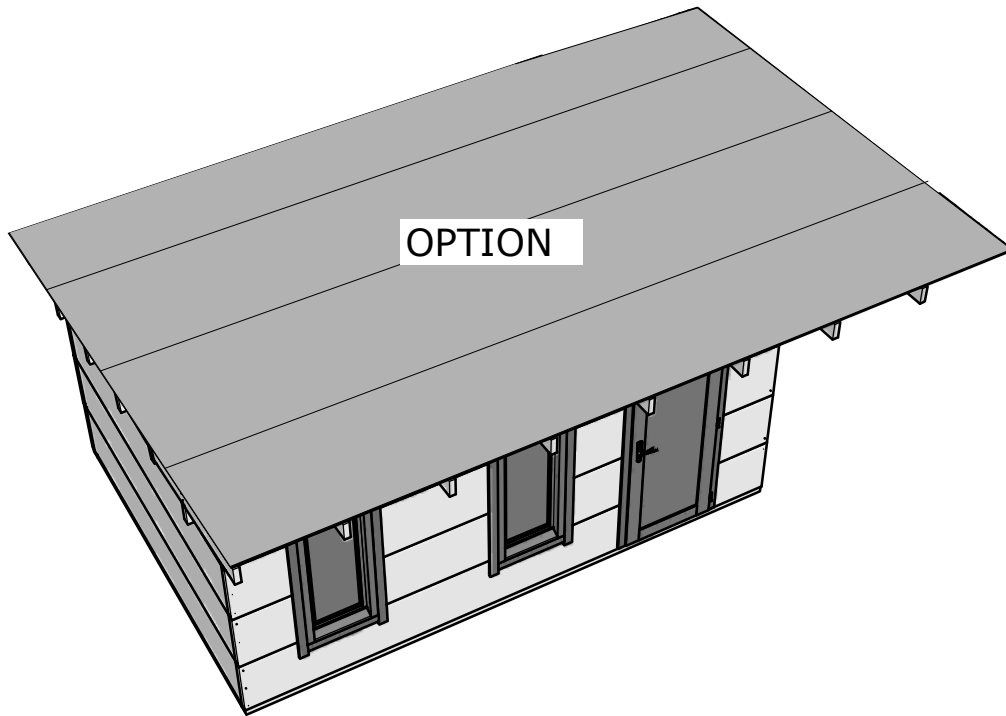

Plan:

Positions: 200, 201, 202, 203, 204

 8 x (QKRPP4_5x50Zn)

 8x (QKRYP6_3x80kZnSK)

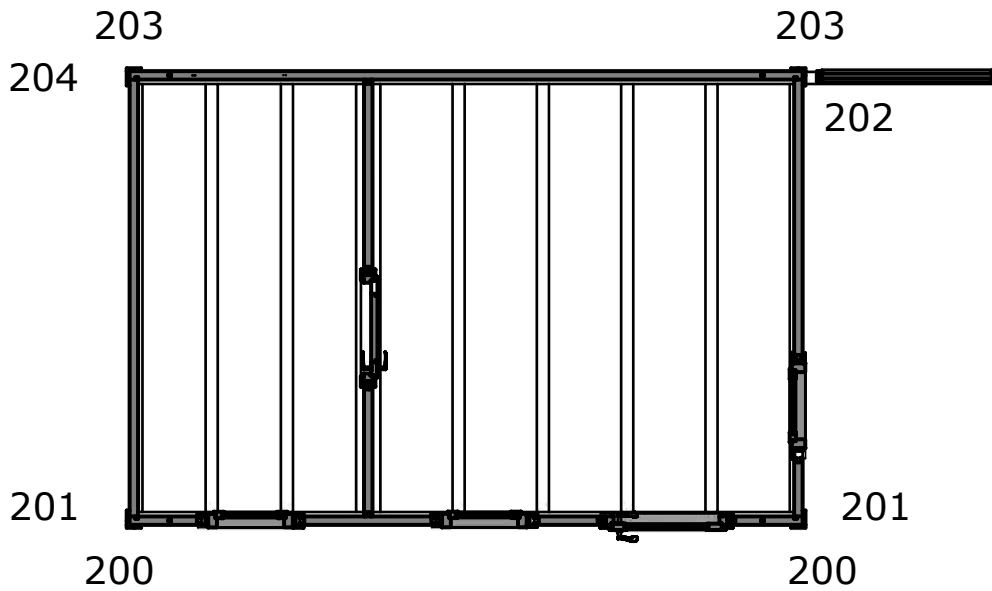
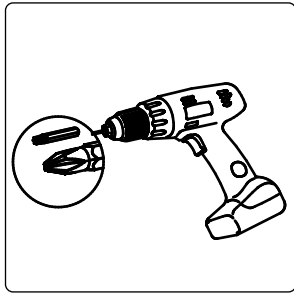
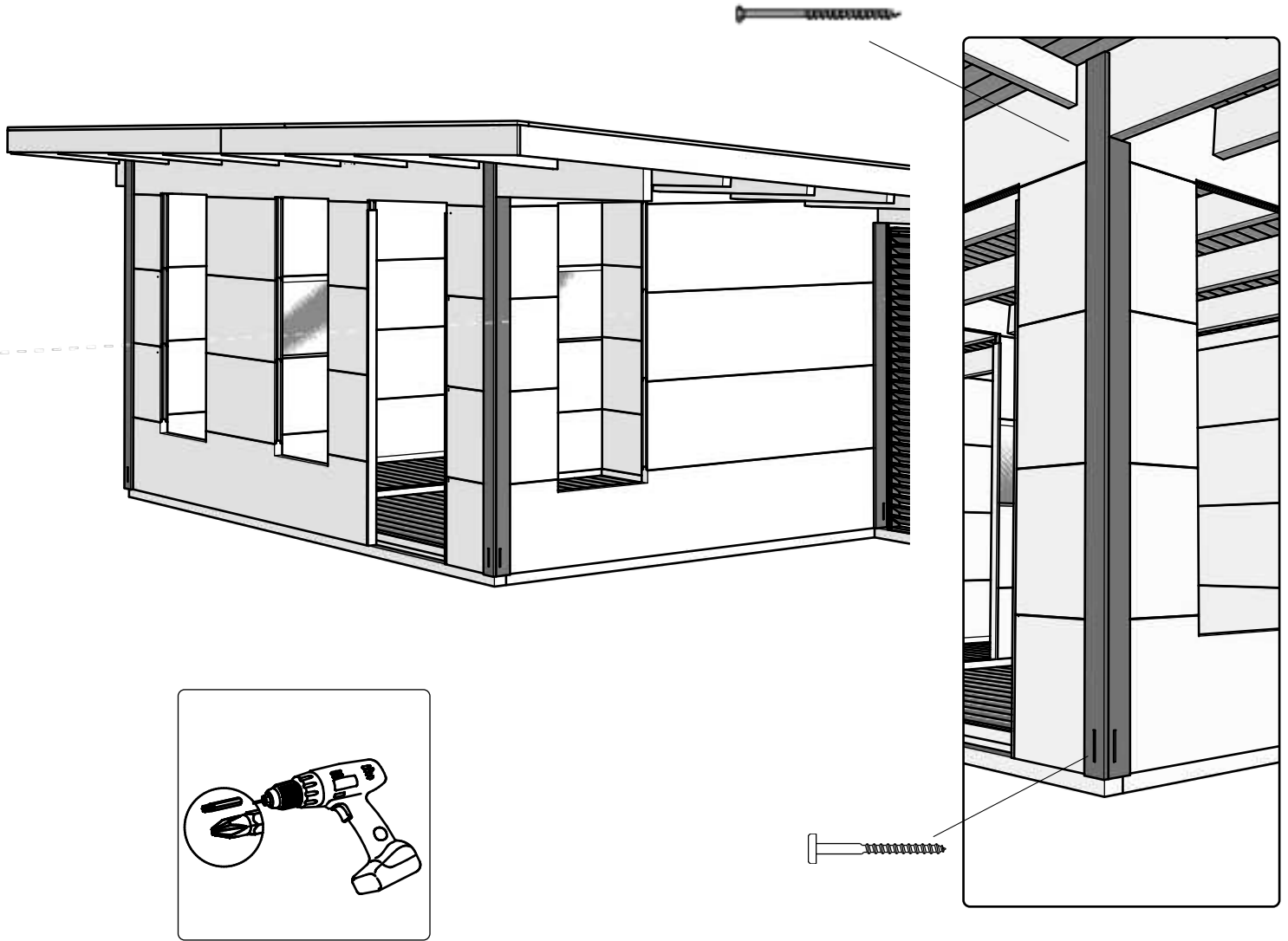

Plan:

Positions: 143

 3 x (QKRP4_5x50Zn)



Plan:

Positions: 103; 106

 130 x (QNA3X70Zn)

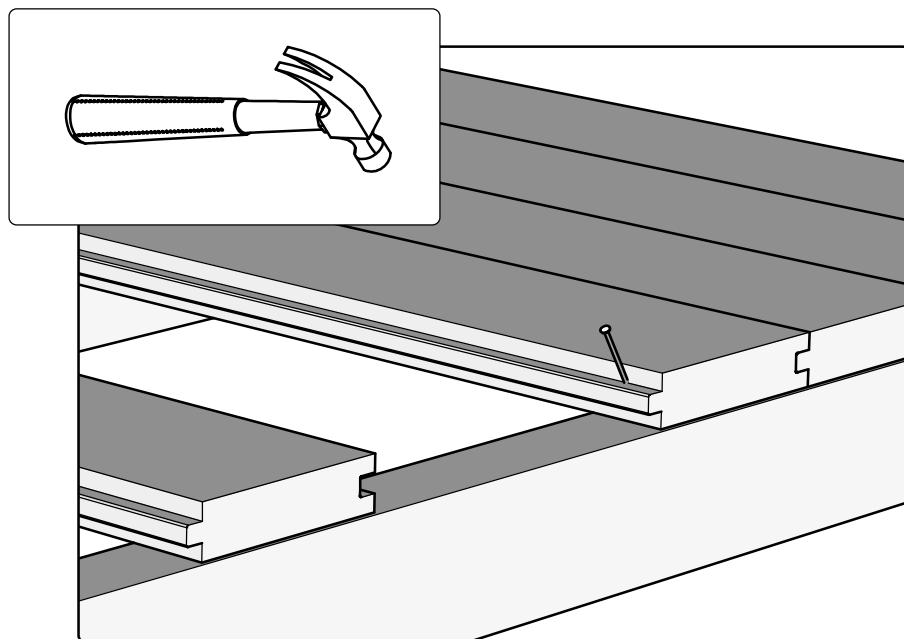
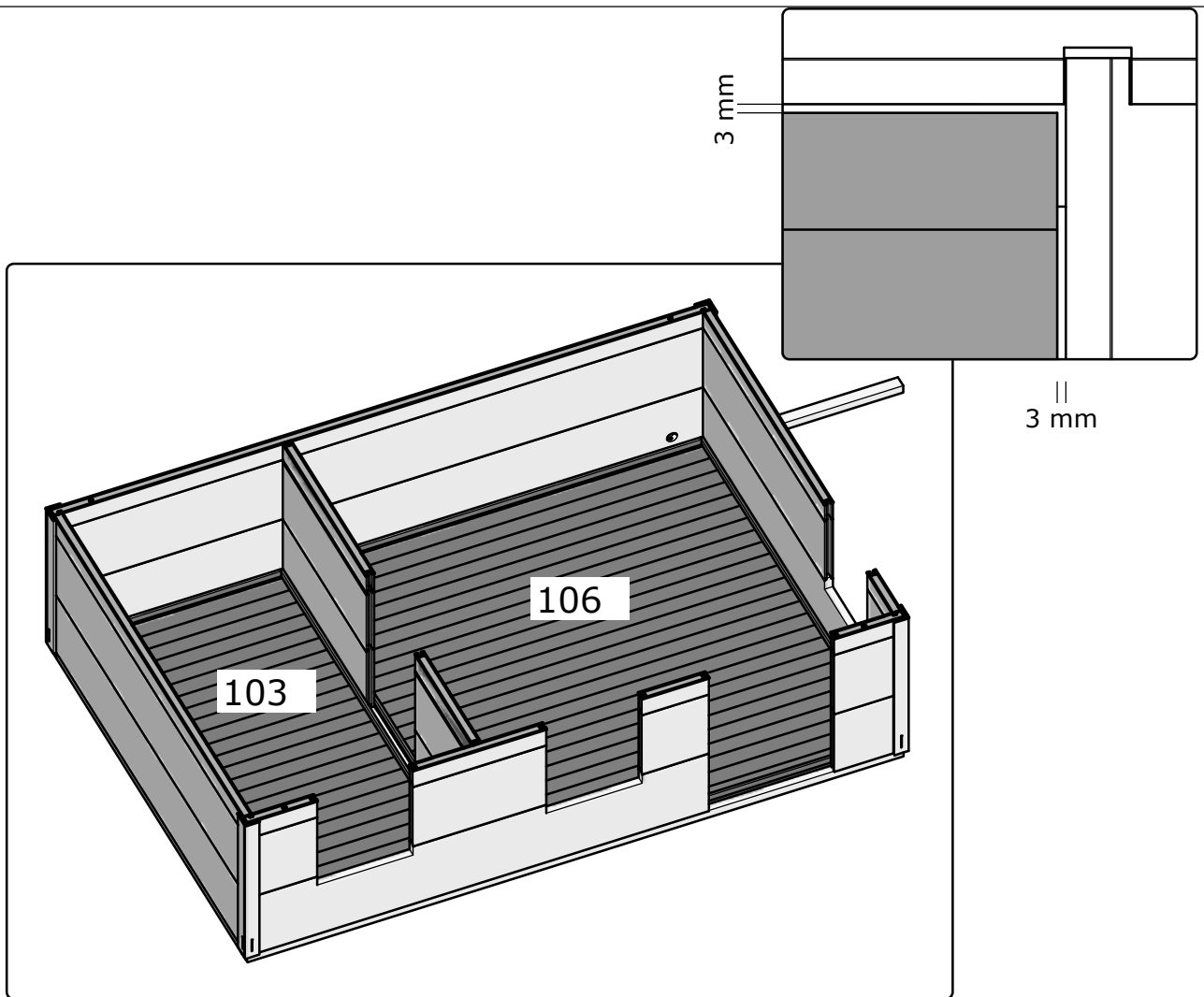



16 x (QRKPP4_5x50TxZn)



x 4

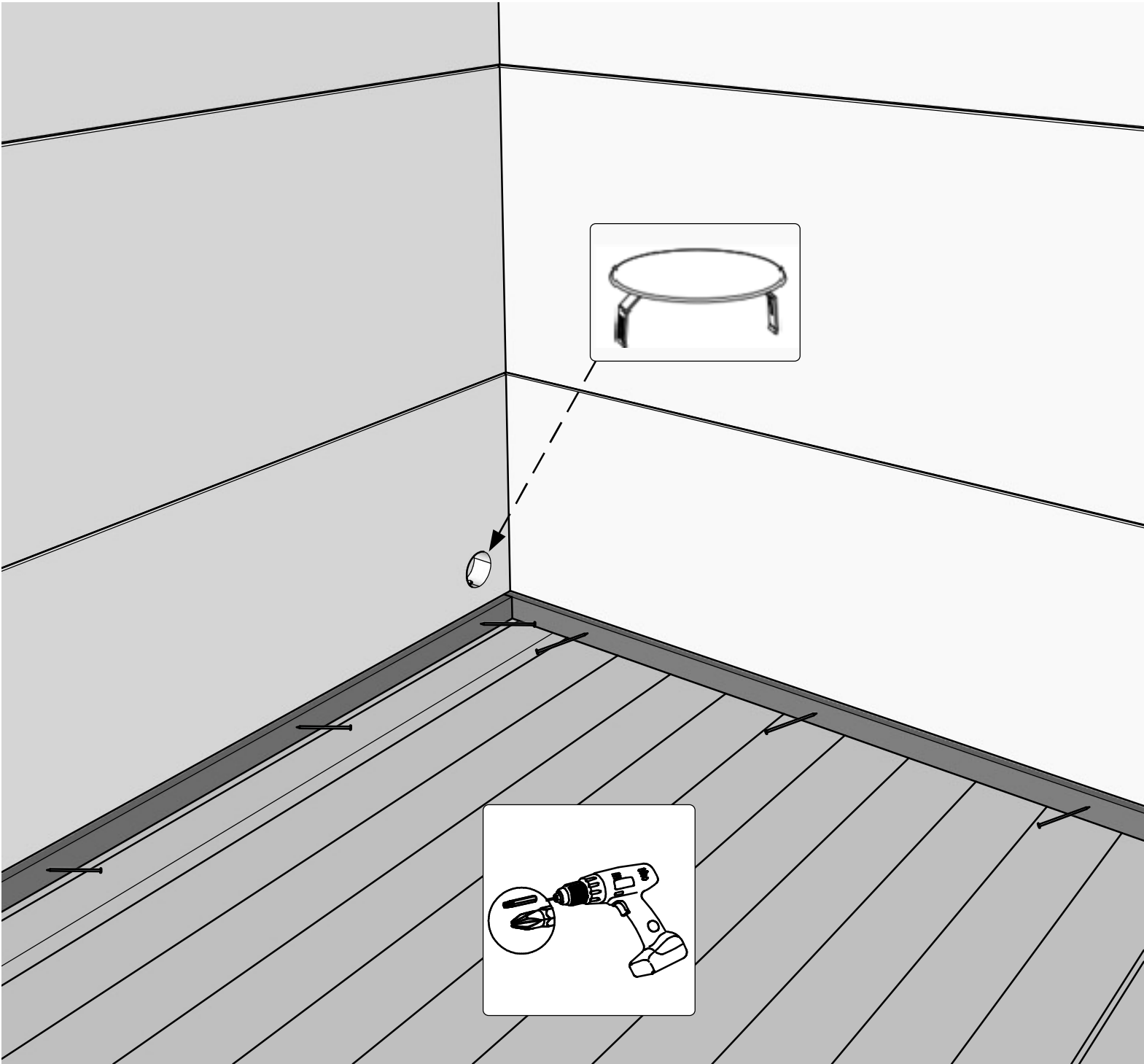

Plan:

Positions: 300, 301, 302, 303

 50 x (QKRPP4_5x40Zn)

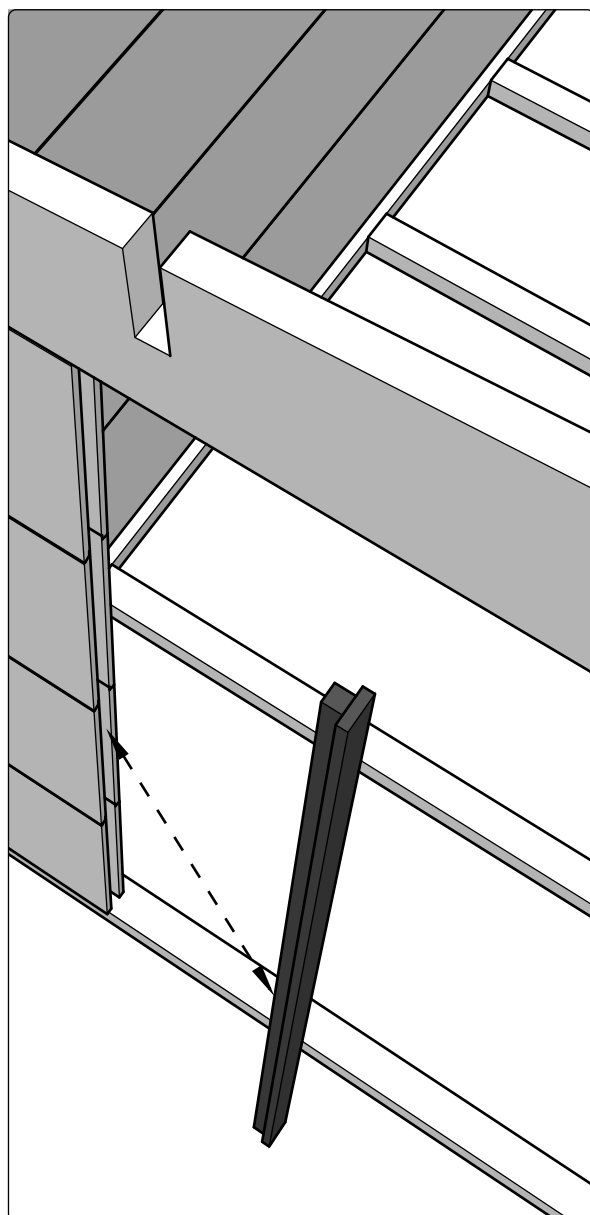
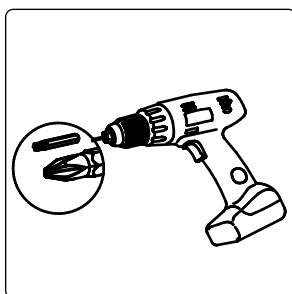
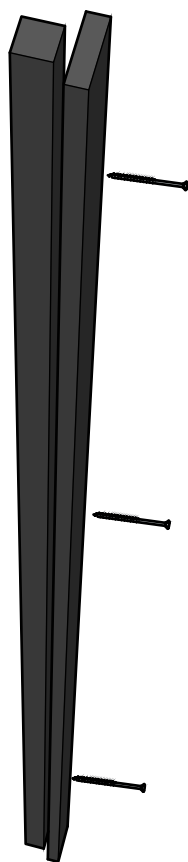
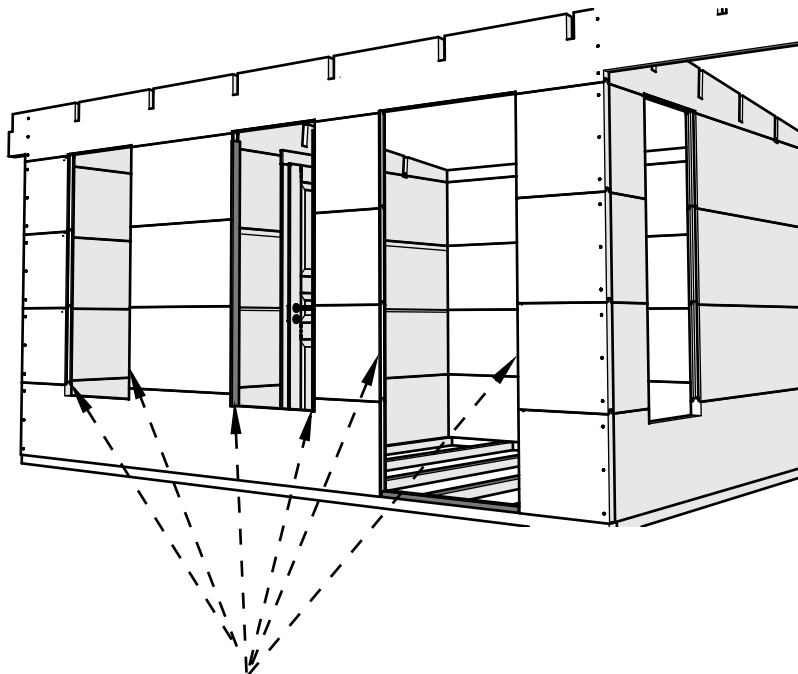

Plan:

Positions: 139, 140, 141, 142, 145, WG1-1

 66 x (QKRP4_5x50Zn)

 5 x (QKRP3_5x40Zn)

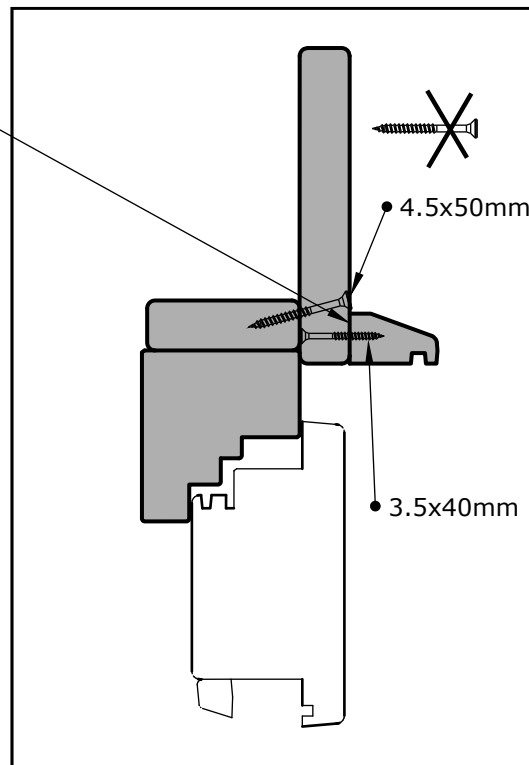
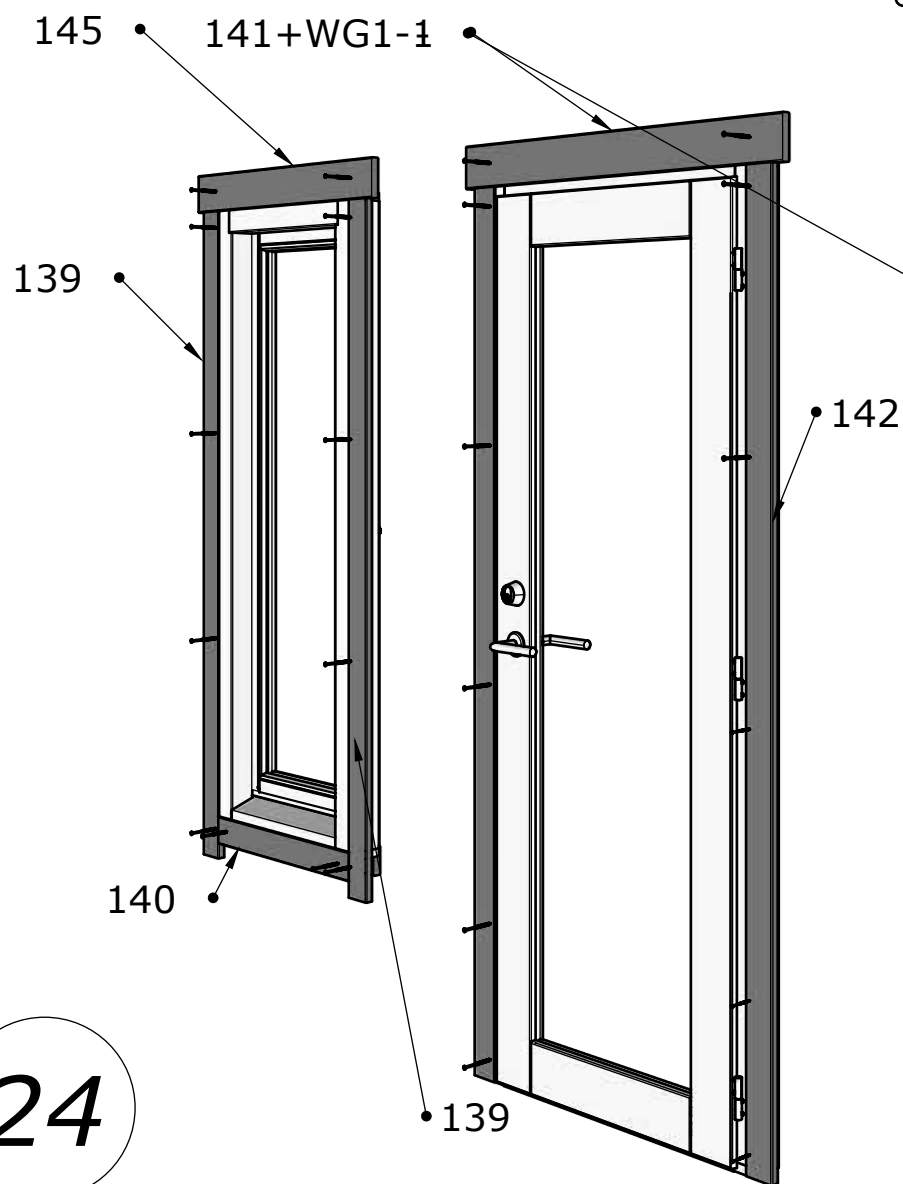
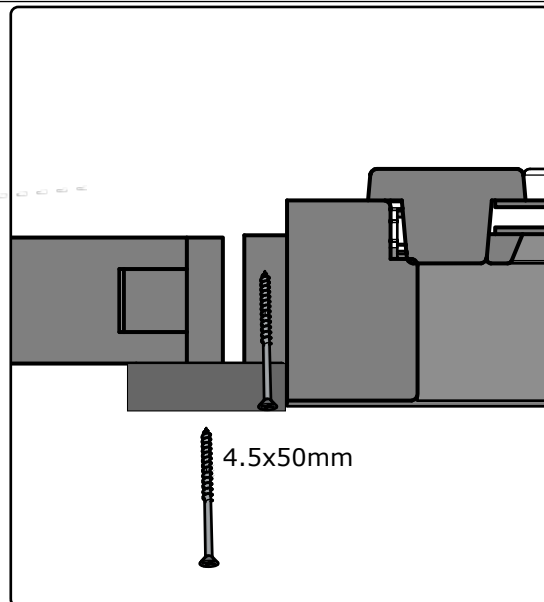
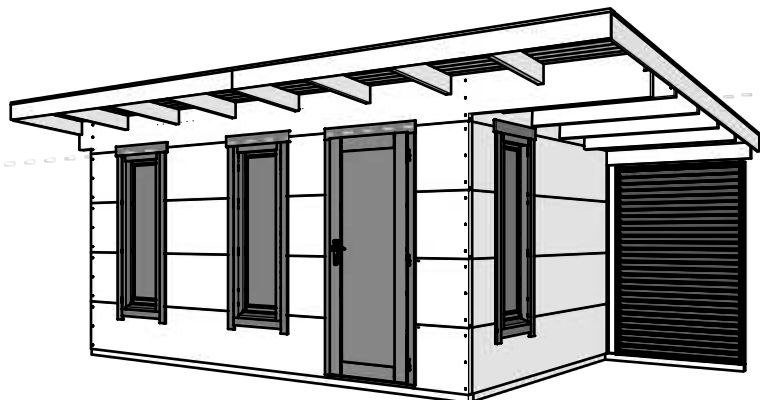



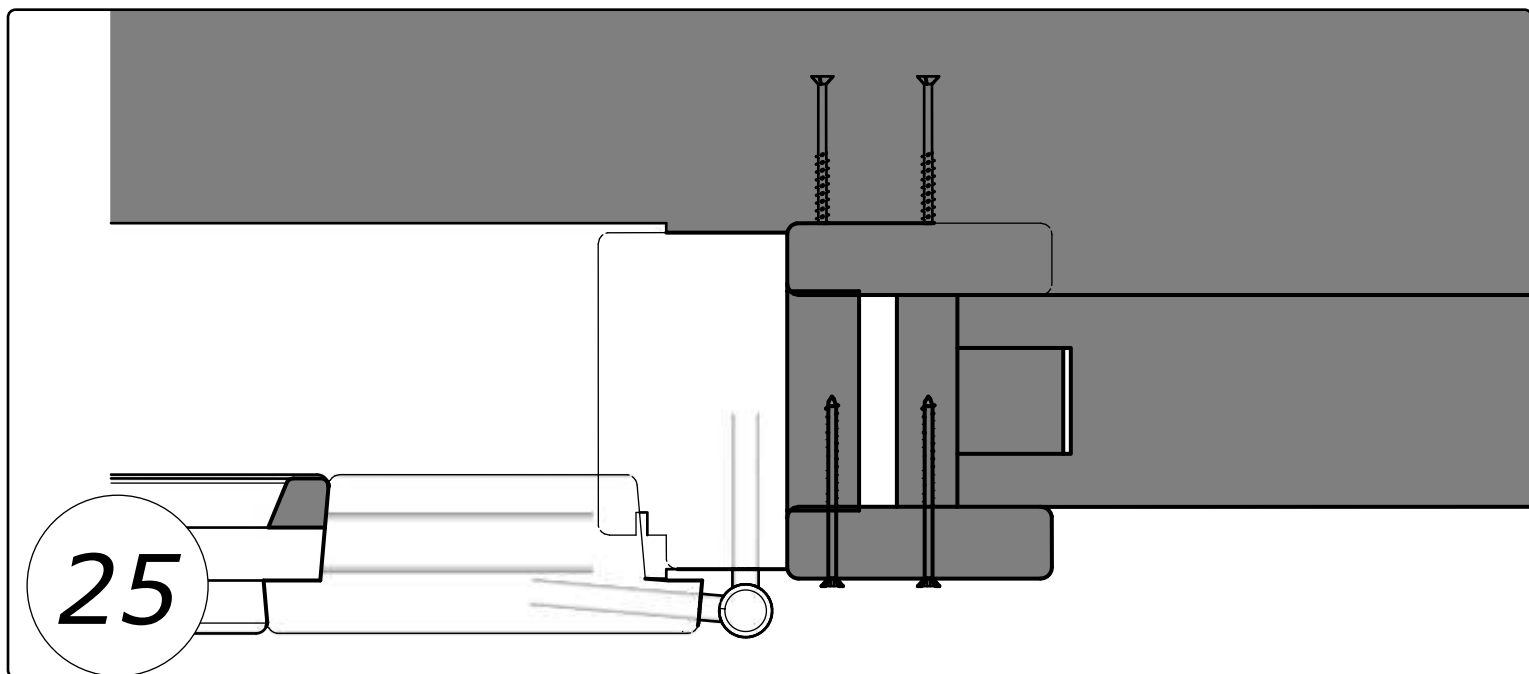
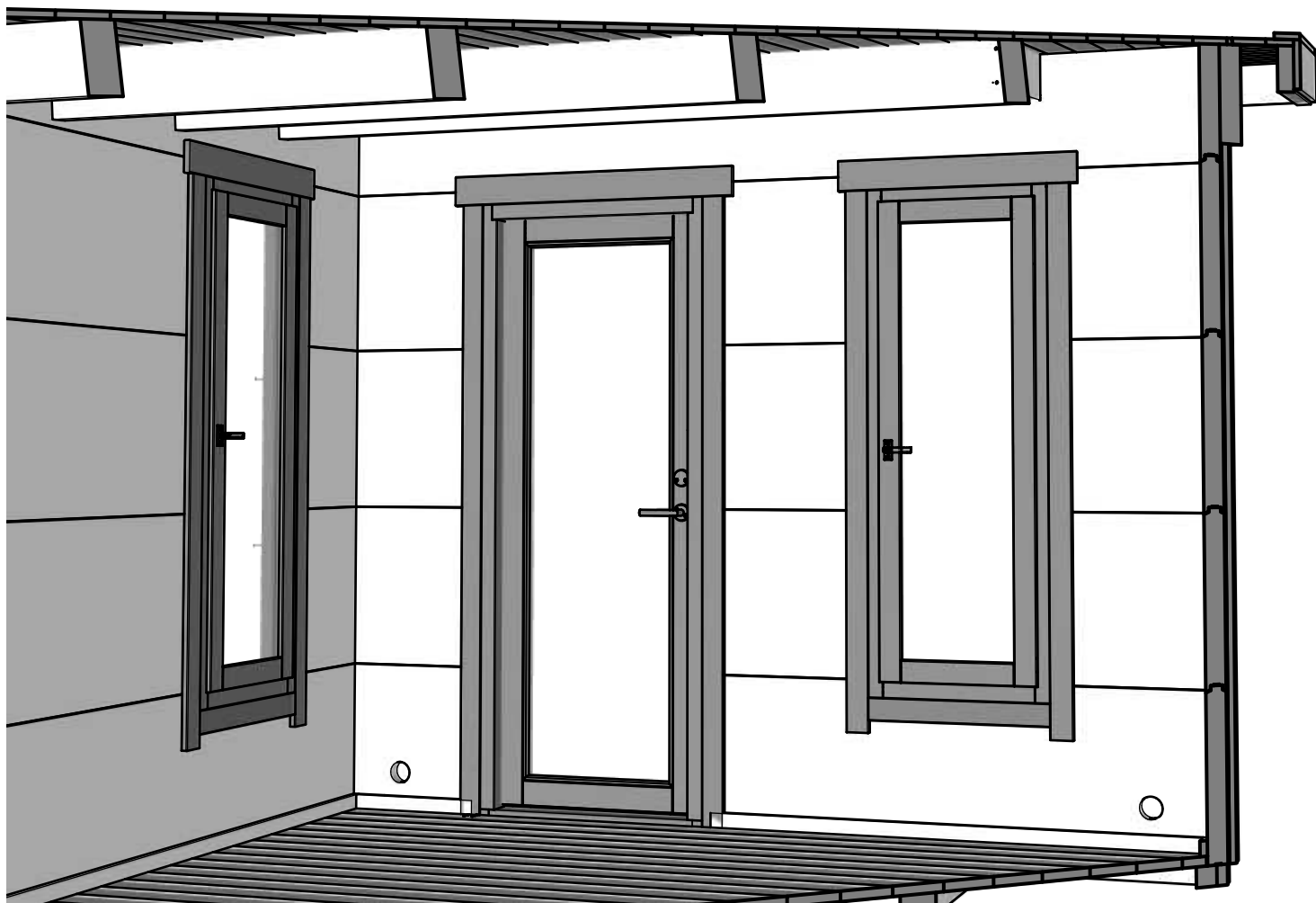

Plan:

Positions: 139, 140, 142, 141, 145

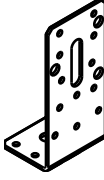
 66 x (QKRP4_5x50Zn)

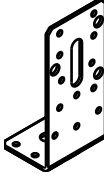

- Plan:  4x (QKRYP3_5x16Zn)  2 x (QNU50x65x130zn)
- Positions:  4x QKRP4_5x40Zn 
-  4x QKRP4_5x50Zn  2 x (QKRKK8x30Zn)

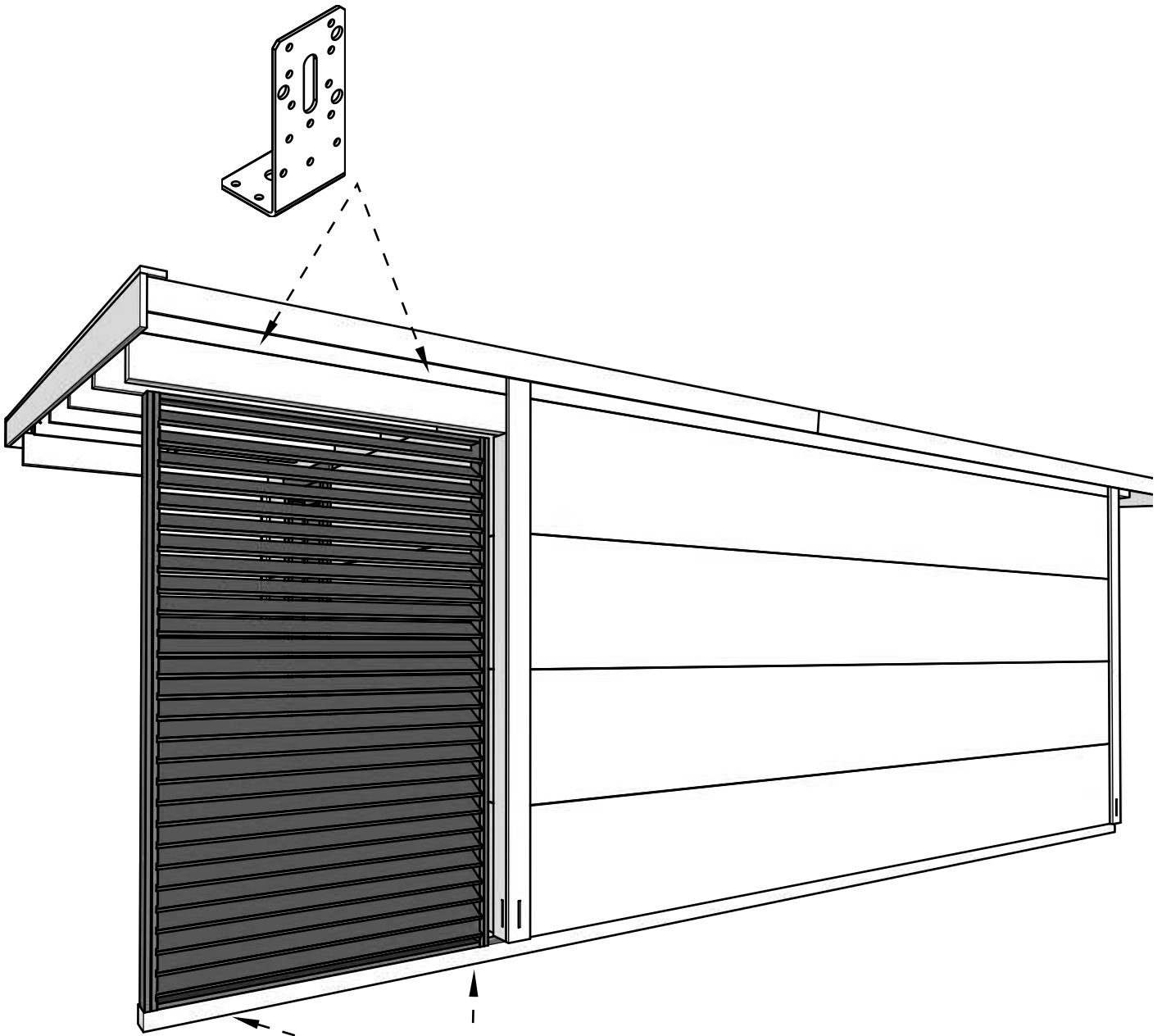

 QKRP4_5x50Zn

