

Technische Daten



Spiegelbar

Artikelnummer:

534 375

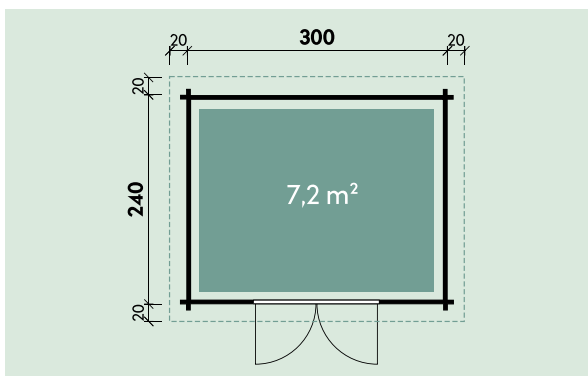

Kontrolliert durch:

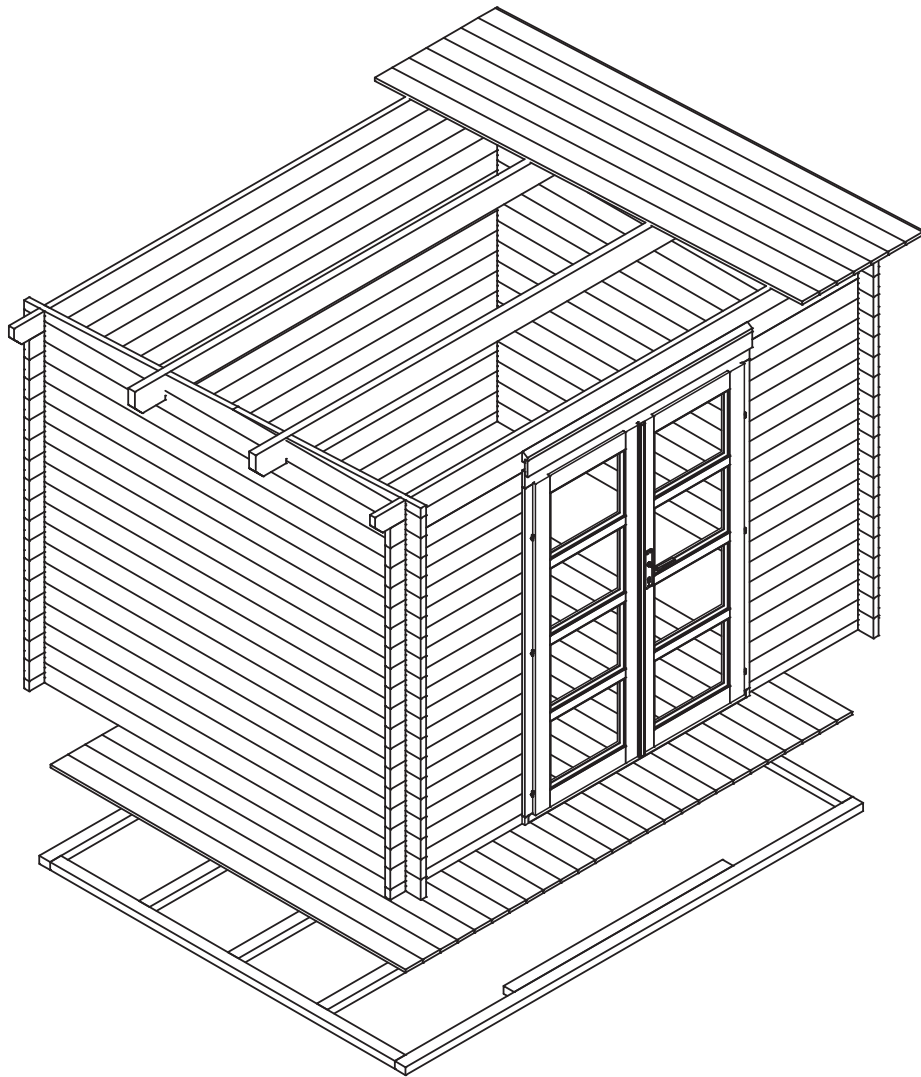

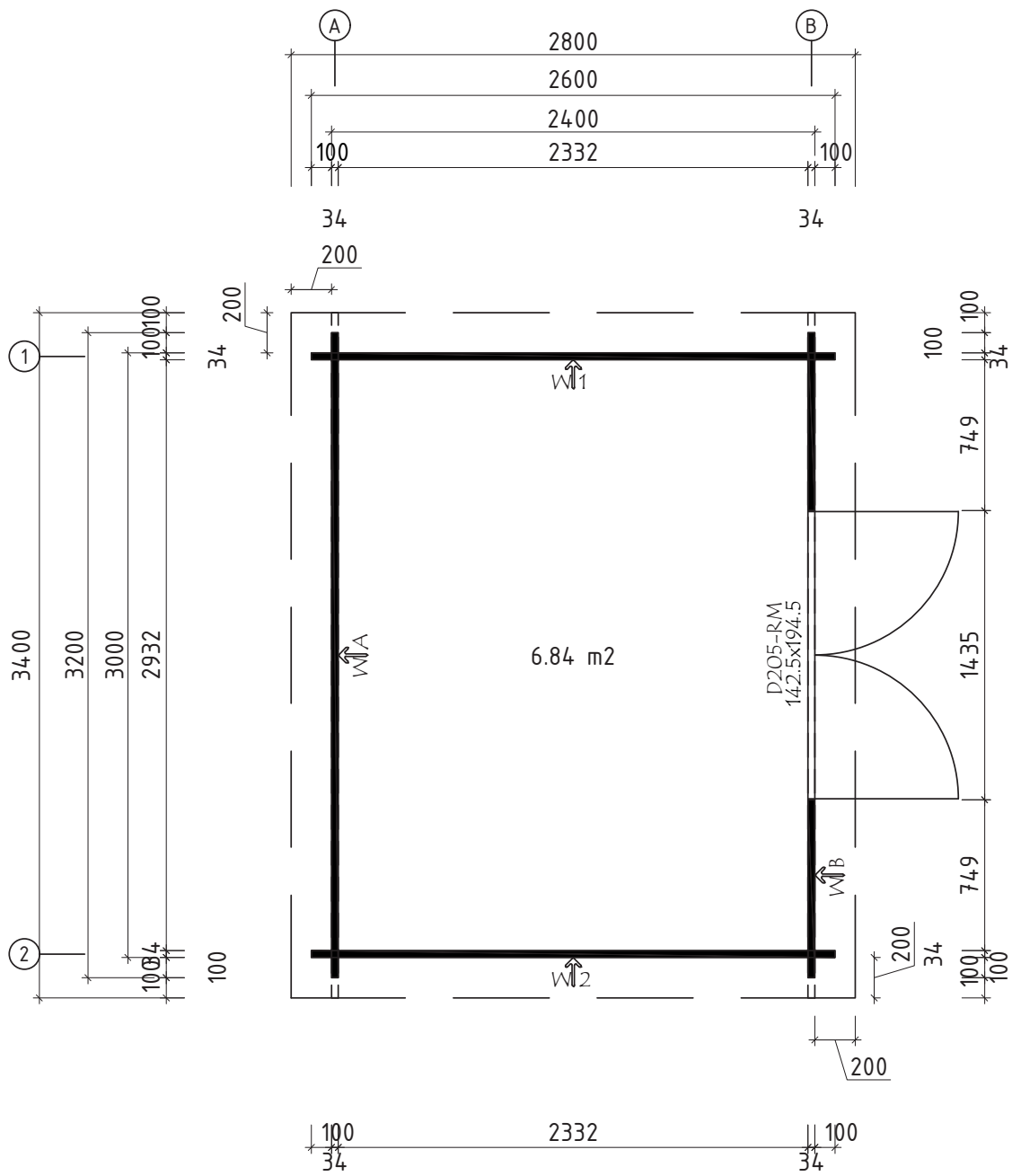





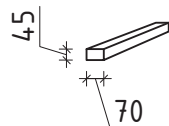
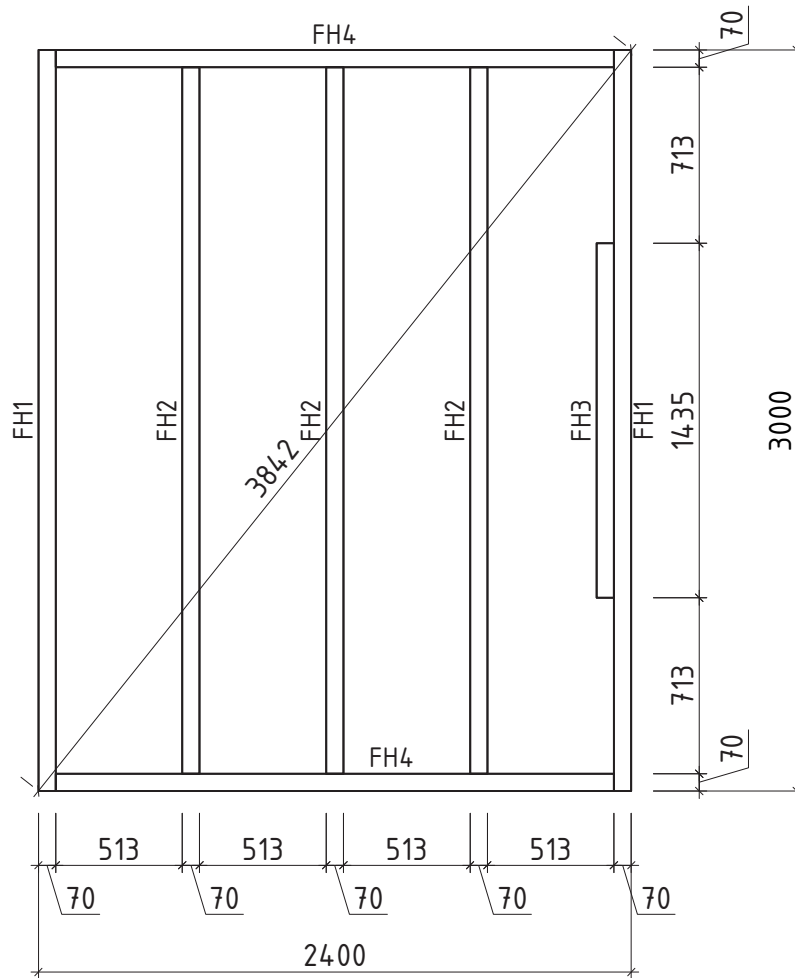

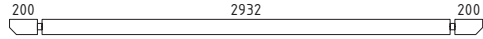
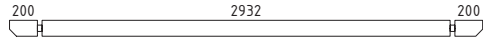
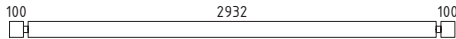
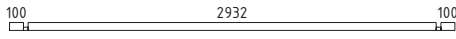
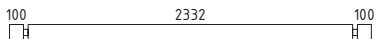
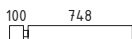
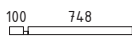
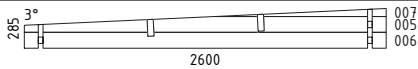
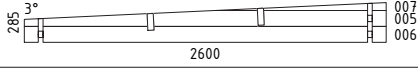



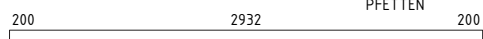





Q3 – Qualitätsklasse für Fenster und Türen

Wir empfehlen als Fundament für Ihr Gartenhaus eine vollflächig festgegründete, gepflasterte oder betonierte Fläche. Wahlweise ist auch ein Punkt- oder Streifenfundament möglich.



Pos	Teileliste 534375	Stck	Profil (mm)	Länge (mm)
001		1	34x109	3400
002		1	34x114	3400
003		18	34x114	3200
004		1	34x57	3200
006		34	34x114	2600
008		34	34x114	883
009		2	34x57	883
W1-1		1		
W2-1		1		
FH1	FUNDAMENTHÖLZER (imprägniert) 	2	70x45	3000
FH2	FUNDAMENTHÖLZER (imprägniert) 	3	70x45	2860
FH4	FUNDAMENTHÖLZER (imprägniert) 	2	70x45	2260
FH3	FUNDAMENTHÖLZER (imprägniert) 	1	70x45	1435
PF1	PFETTEN 	2	44x145	3400
	DACHBRETTER 	31+1	113x18	2805
	FUSSBODENBRETTER 	26+1	113x18	2325
	FUSSBODENLEISTEN  ✓		18x40	12.0lfm
G02-1	GIEBELBRETTER 18x120  ✓	2	18x120	2825
G05-1	GIEBELDECKLEISTEN 18x40  ✓	2	18x40	2805
T02-1	TRAUFENBRETTER 18x120 	1	18x120	3436
T01-1	TRAUFENBRETTER 18x95 	1	18x95	3400
T04-1	TRAUFENDECKLEISTEN 18x40 	1	18x40	3436
T06-1	TRAUFENLEISTEN 18x40  ✓		18x40	7.0lfm
SM-1	Sturmleisten 	2	18x40	2025
SM-2	Sturmleisten 	2	18x40	2140

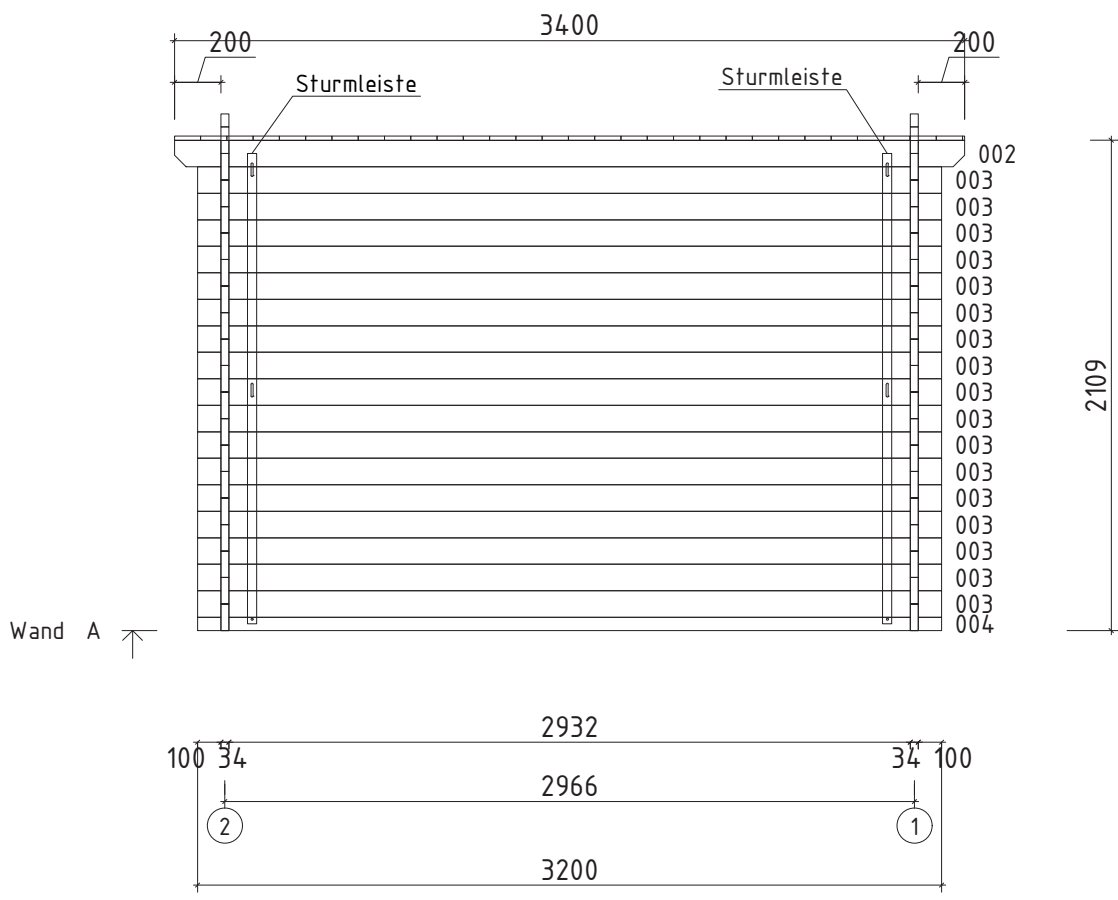

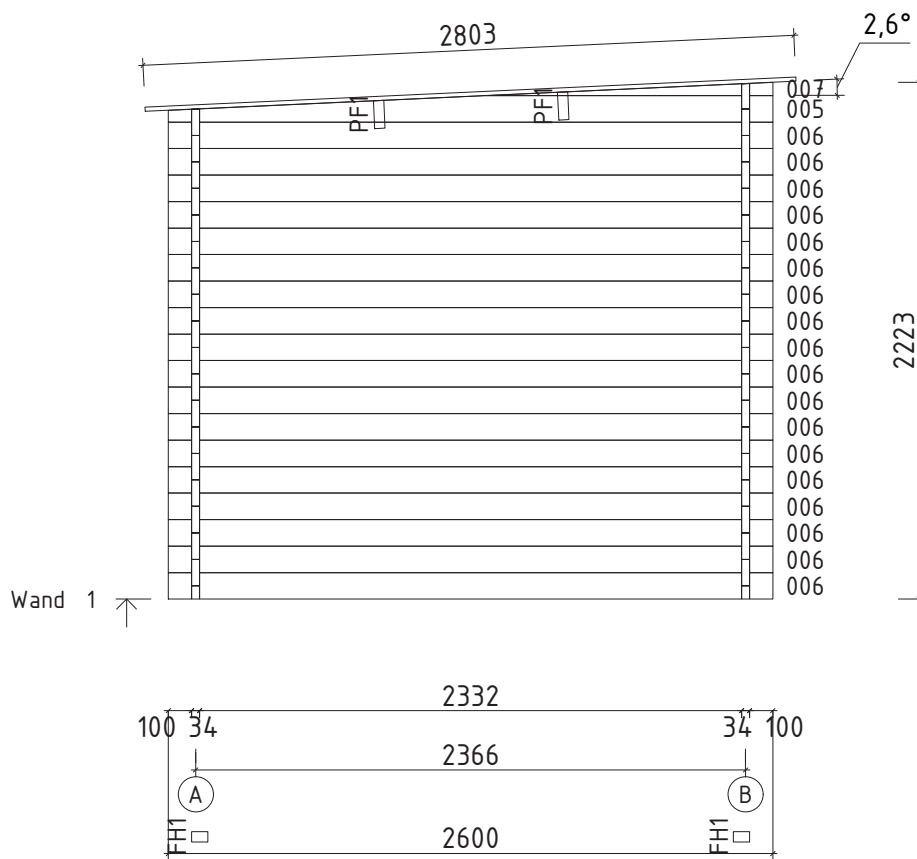

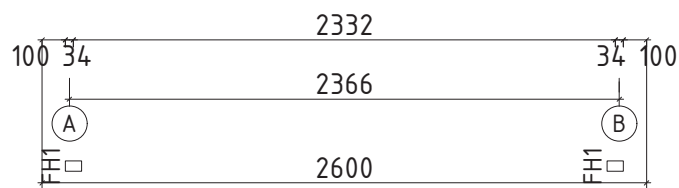
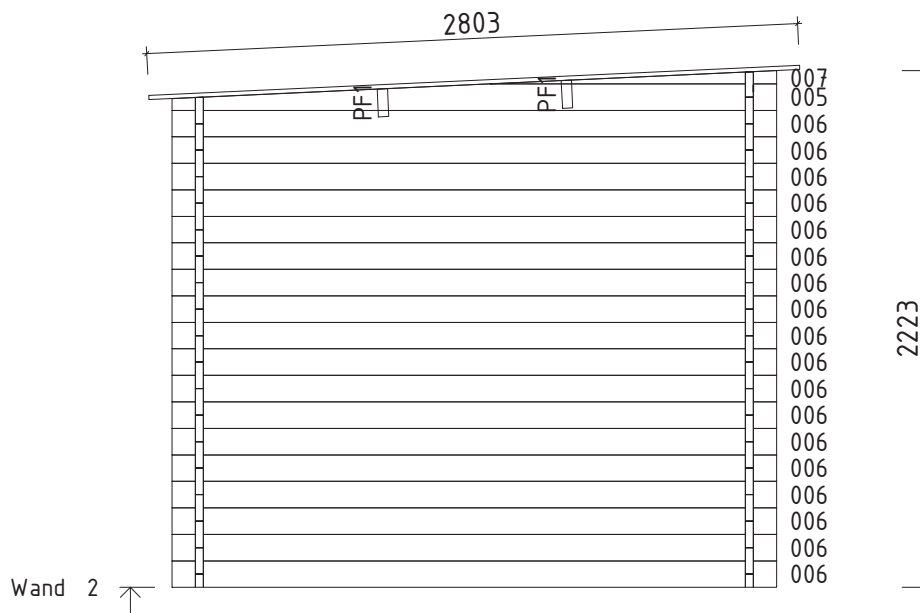
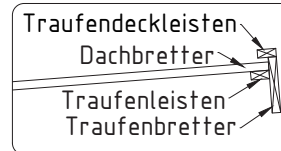
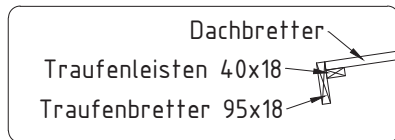

<p>Uks Door Tür</p>	<p>Q2-Q3 Q2-Q3 Q2-Q3</p>	<p>- - -</p>	<p>koostamisjuhhis assembly instructions Montageanleitung</p>		
				<p>* Kui hinged ei ole paigaldatud! * When hinges are not attached! * Wenn Scharniere sind nicht angebracht!</p>	